

IMPORTANT: KEEP THIS INSTRUCTION BOOKLET IN THE PLACE PROVIDED AT THE BACK OF THE CHILD RESTRAINT

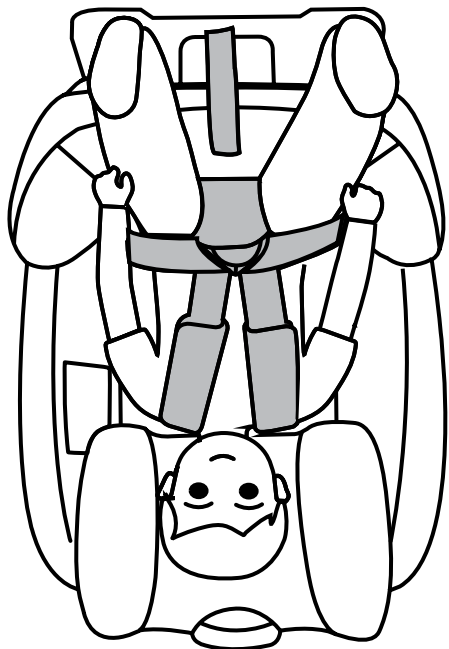

USE WITH A CHILD



Joie  
MODEL C2005B  
instruction manual

Joie™

INSTALLATION  
IN A VEHICLE

Joie  
MODEL C2005B  
instruction manual



IMPORTANT: KEEP THIS INSTRUCTION BOOKLET IN THE PLACE PROVIDED AT THE BACK OF THE CHILD RESTRAINT

**IMPORTANT:**

Before installation and use of this child restraint check that it is suitable for the size of your child.

Refer to the shoulder height label information on pages 9 and 19 of the USE Instructions.

**Which way to face the restraint?**

Install facing the back of the vehicle for babies and small toddlers.

Install facing the front of the vehicle for bigger toddlers and small children.

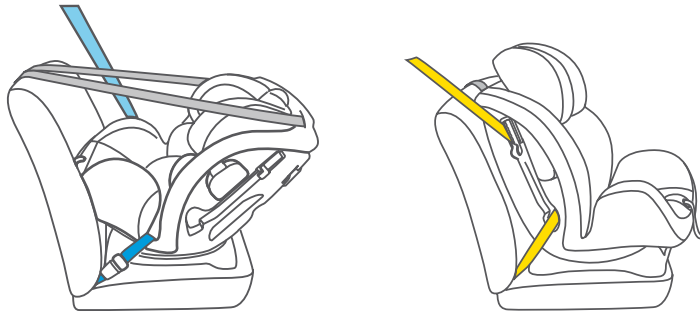

FRONT OF VEHICLE →

**DO NOT USE THIS CHILD RESTRAINT UNTIL YOU HAVE READ AND UNDERSTOOD THE INSTRUCTIONS IN THIS USER GUIDE AND IN YOUR VEHICLE OWNERS MANUAL**

**Distributed by Nuna Baby Australia Pty Ltd**

**ACN: 642 240 140**

Unit 1, 35 Lyn Parade Prestons, NSW Australia 2170

For after-sales & warranty service, contact: 1800 951 070

customerservice@nunababy.com.au

Keep these Instructions for future reference.

**CONTENTS**

**WARNINGS** ..... 3

ADDITIONAL WARNINGS ..... 4 & 5

Features ..... 6 & 7

**REAR FACING INSTALLATION**

Recline Angle ..... 8

Installing the Restraint ..... 9 - 12

CHECKLIST ..... 13

**FORWARD FACING INSTALLATION**

Recline Angle ..... 14

Installing the Restraint ..... 15 - 18

CHECKLIST ..... 19

**TOP TETHER WARNINGS** ..... 20

Top Tether Features ..... 21

Tether Anchorage Installation ..... 22 - 24

Read the whole of these instructions carefully and if there is any doubt about the method of installation, consult the child restraint manufacturer or agent, or a child restraint fitting station authorized by the relevant transport authority, or in New Zealand an agent for the vehicle.

## WARNINGS

### GENERAL WARNINGS

- Use the restraint exactly as shown in the instructions.
- Do not alter or modify this restraint.
- Repairs must only be done by the manufacturer or agent.
- Do not allow the restraint to come into contact with polishes, oils, bleach and other chemicals.
- Destroy the restraint if it has been in a severe crash, even if no damage is visible.
- A loose harness or restraint is dangerous.
- Fit the restraint firmly to the car seat.
- **DO NOT USE A REAR FACING CHILD RESTRAINT WHERE AN AIRBAG IS FITTED IN FRONT OF THE SEATING POSITION.**
- **DO NOT LEAVE CHILDREN UNATTENDED IN THE CAR**

This child restraint is not approved for use with any connectors that connect to the car's ISOFIX low anchorages.

NOTE: The warnings on this page are required by the Australian and New Zealand Standard AS/NZS 1754 for this type of child restraint.

Other warnings specific to this child restraint will be found on the following pages and throughout these instructions.

## ADDITIONAL WARNINGS

TO BE USED WITH A LAP-SASH/LAP ONLY SEAT BELT IN THE BACK OF MOST CARS WITH FORWARD FACING SEATS.

- When installed rearward facing this restraint is 710 mm long, 500 mm wide and 515 mm high. Check the measurement between the front of the seat back of the rear seat and all front seats in the car in which the restraint is intended to be used to ensure the space available is sufficient.

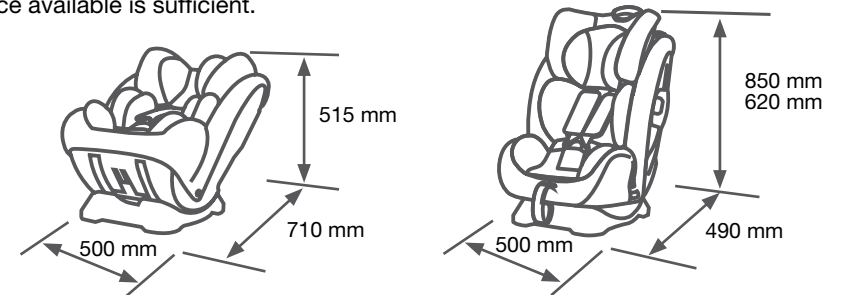

- Do not use seat belt extenders if the car seat belt is not long enough to secure the child restraint. If the vehicle seat belt is not long enough to secure the restraint seek advice from a child restraint fitter.
- Read carefully the whole of the instructions for the installation, and in the event of doubt about the method of installation, consult the child restraint manufacturer or agent, or a child restraint fitting station authorized by the relevant transport authority, or in New Zealand, consult the agent for the vehicle.
- Aftermarket accessories (i.e. items not provided in the box with the child restraint), may not have been tested for use with this child restraint and if used, may lower the level of protection offered possibly leading to injury or death.
- Any aftermarket accessory used should be compliant with AS/NZS 8005 (Accessories for child restraints for use in motor vehicles) and stated as suitable for use with this child restraint.

## ADDITIONAL WARNINGS

Only install child restraint in a forward facing vehicle seat. Never install in a seat that faces the rear or the side of the vehicle.

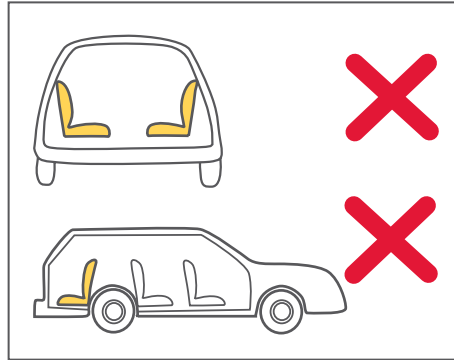

Never install the Child Restraint in a seat with a front airbag. DEATH or SERIOUS INJURY may occur. Refer to your vehicle Owners Manual for airbag warnings and information.



### IMPORTANT

Some vehicles have airbags attached to the sash belt. DO NOT install the restraint using this type of belt. If in doubt refer to the vehicle owners manual or an approved child restraint fitter.

## Features

- |   |                                |    |                                 |
|---|--------------------------------|----|---------------------------------|
| 1 | Headrest height Adjustor       | 6  | Recline Angle Adjustment Handle |
| 2 | Seat Cover                     | 7  | Crotch Pad                      |
| 3 | Harness QR Buckle              | 8  | Shoulder Harness Strap          |
| 4 | Harness Adjuster (under cover) | 9  | Shoulder Harness Strap Cover    |
| 5 | Harness Adjuster Webbing       | 10 | Infant Body Support             |

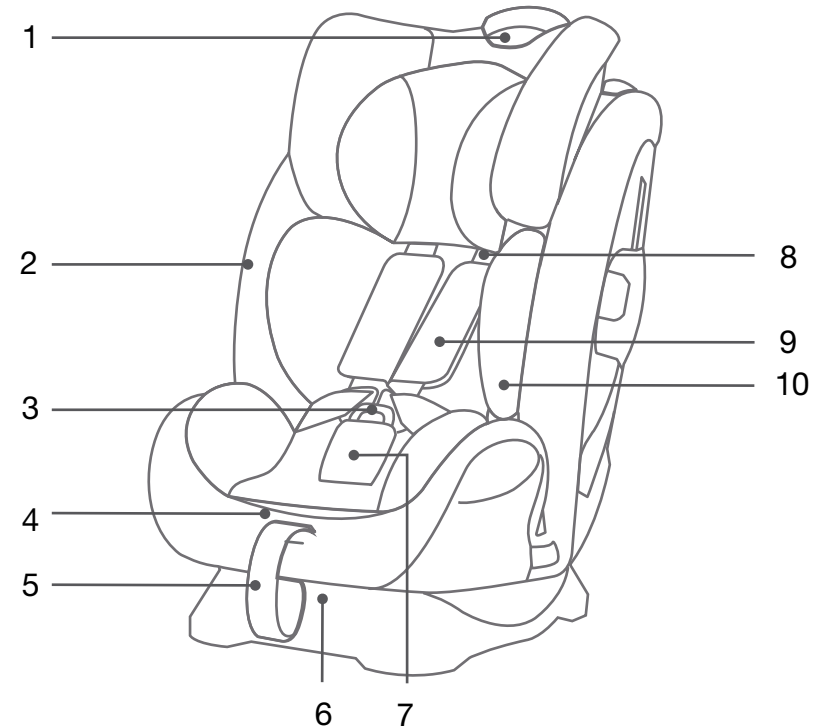

## Features

- |    |                              |    |                                  |
|----|------------------------------|----|----------------------------------|
| 11 | Top Tether Anchorage         | 17 | Instructions Storage             |
| 12 | Top Tether Snap Hook         | 18 | Base                             |
| 13 | Top Tether                   | 19 | Tether End Storage Bag           |
| 14 | Headrest Adjuster            | 20 | Seat Shell                       |
| 15 | Sash Belt Lock-off Device    | 21 | Forward-Facing Vehicle Belt Slot |
| 16 | Extra side impact protection | 22 | Rear-Facing Vehicle Belt Slot    |

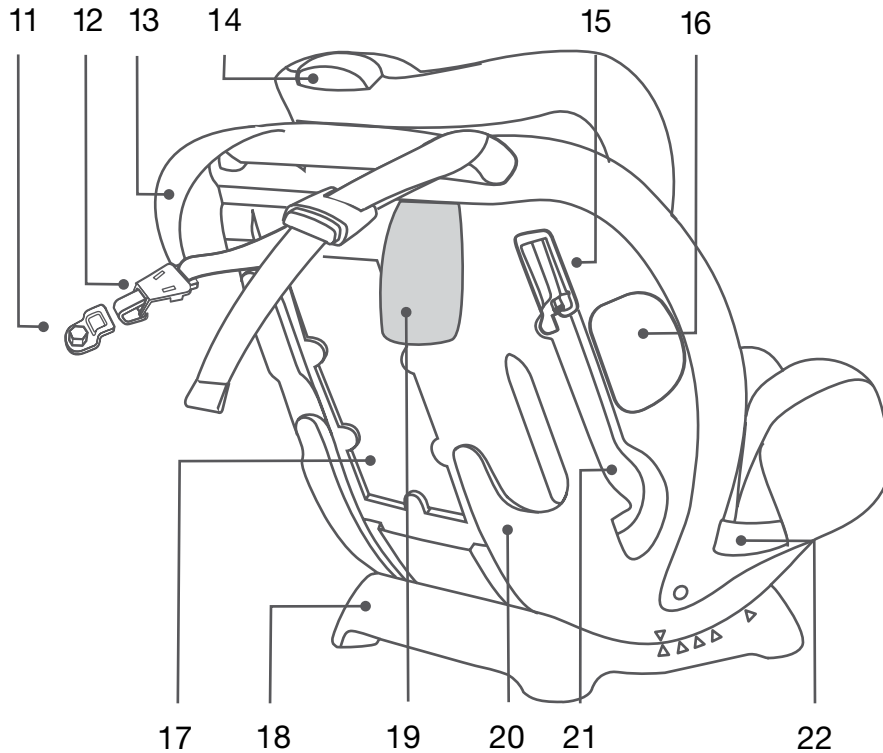

## Recline Angle

This restraint should be installed in the rear seat.

### Correct Recline Angle

When used rear facing the restraint must always be fully reclined. The white arrow on the shell must be above the blue arrow on the base.

**IMPORTANT:** A correct recline angle is essential for your baby's safety.

### To Adjust:

1. Pull the release handle on the shell fully forward.

2. Rotate the shell until the white arrow is above the blue arrow.

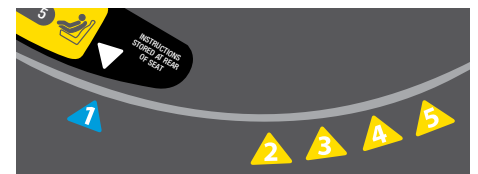
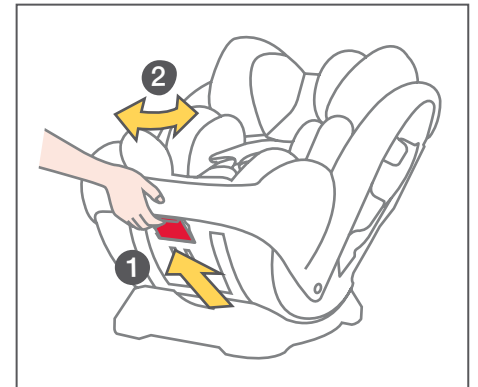
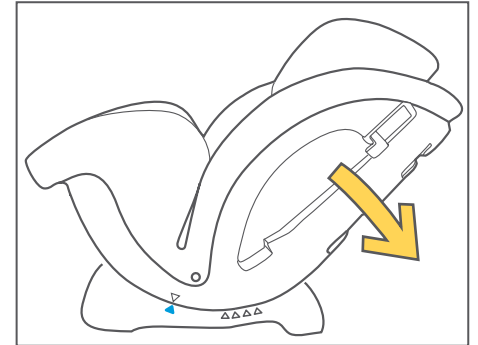

## Installation

Place the restraint on the vehicle seat rear facing.

See page 5 for recommended positions in the vehicle.

1. Pull the vehicle lap/sash belt out and pass through the slot in the restraint.

Pass the vehicle belts over the restraint seating surface and out the other side.

2. Engage the vehicle belt buckle.

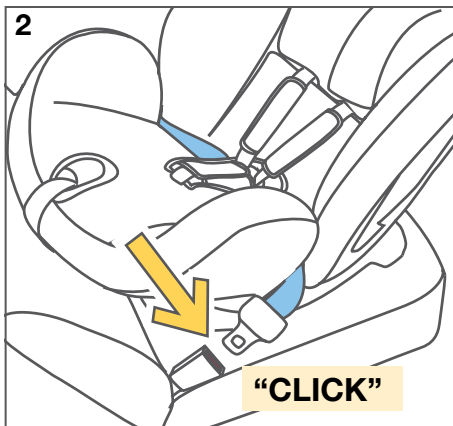
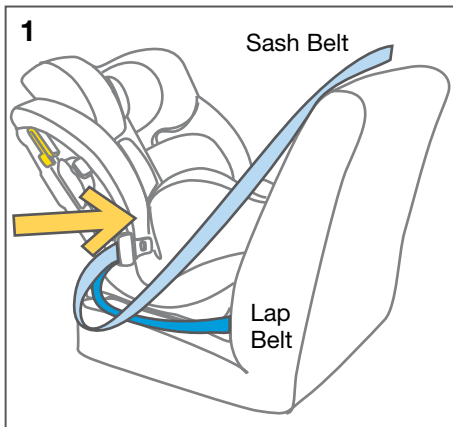

### REARWARD FACING BELT PATH

Look for this label showing the correct path for the vehicle belts

REARWARD FACING BELT PATH

IMPORTANT: the vehicle belts must be fully down in the slots in the side wings

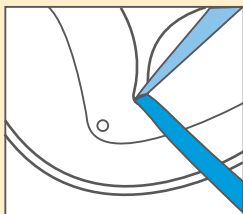

## Installation

3. Pull the vehicle belts tight.

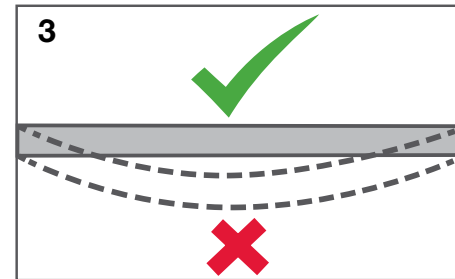

4. Ensure there are no twists in the belts.

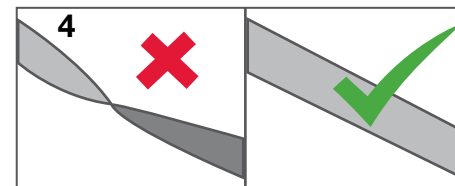

5. Connect the top tether strap.

NOTE: many vehicles have built-in top tether connection points. If your vehicle does not have these refer to page 22 for information on fitting the anchorage supplied.

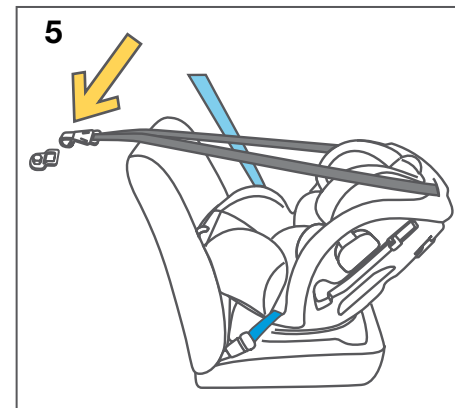

## Installation

6. Store end of web in bag on back of cover.

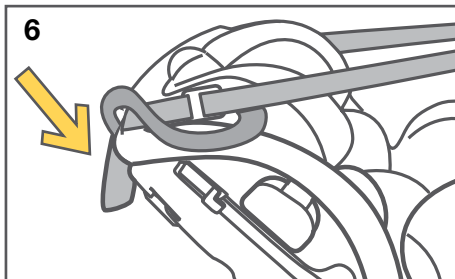

### Tether Strap General Information

Also refer to page 21 for more Top Tether information.

Always connect the snap hook securely to the anchorage fitting.

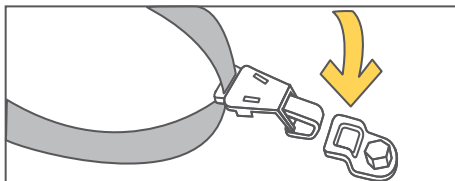

Increase tether tension by pulling web out.

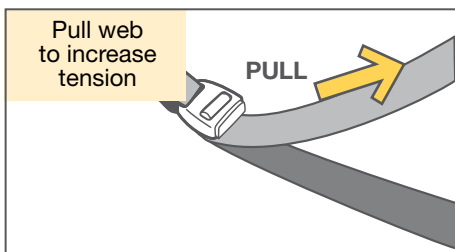

Reduce tension by pressing release button and pulling web out.

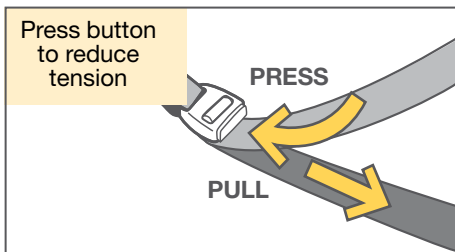

## Installation

Straps must not be twisted.

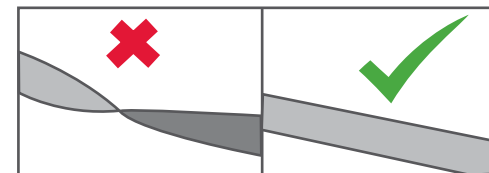

Pull straps pulled tight.

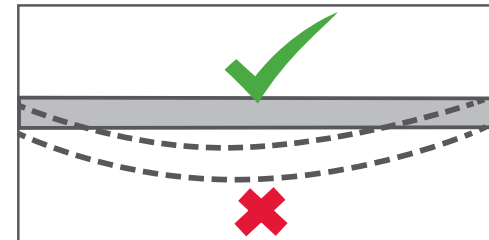

Adjust the tether tension until the tether is pulled tight.

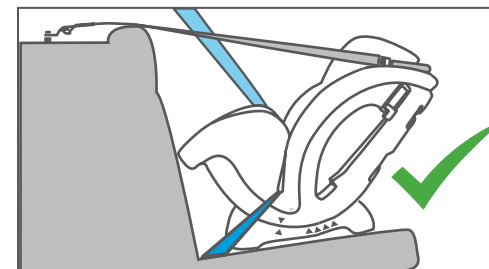

Do not adjust so tight that it lifts the child restraint off the vehicle seat.

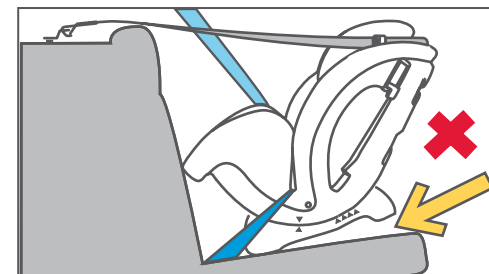

Checklist

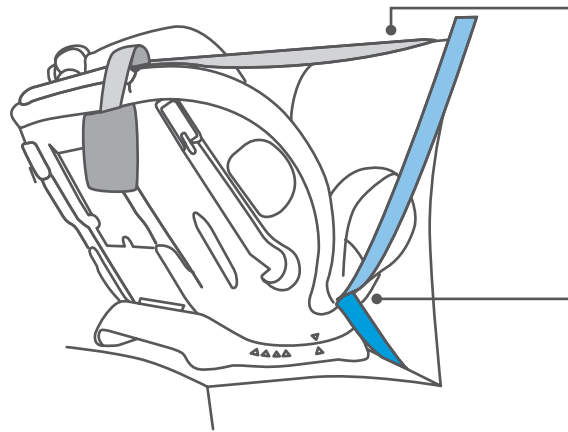

**Tether Strap** - check tension. Ensure there are no twists in the webbing. End of tether in storage bag

**Sash Belt** - fully down in the side slots

**Side Flaps** - these can be opened to provide extra side impact protection. Open on the car door side only.

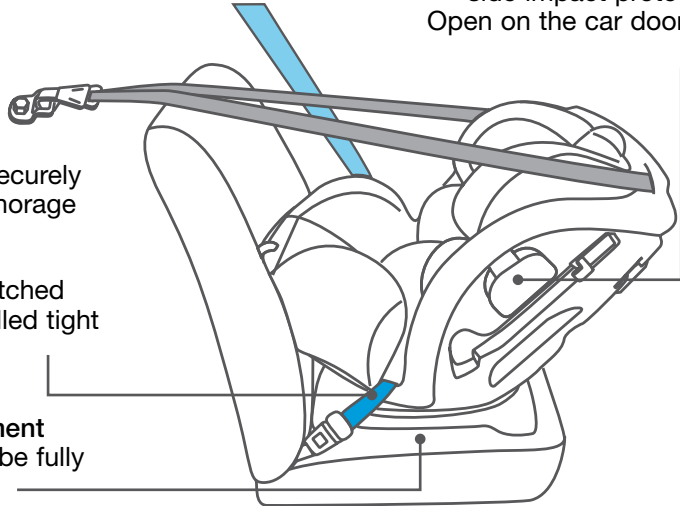

**Tether Strap** - securely attached to anchorage

**Vehicle Belt** - latched securely and pulled tight

**Recline adjustment** - restraint must be fully reclined

Recline Angle

**Correct Recline Angle**

When used forward facing the restraint must always be correctly reclined. The white arrow on the shell must be above one of the yellow arrows on the base.

Select a position that gives the most comfort for your child.

**IMPORTANT** A correct recline angle is essential for your child's safety.

**DO NOT** use the position marked by the blue arrow when the restraint is forward facing.

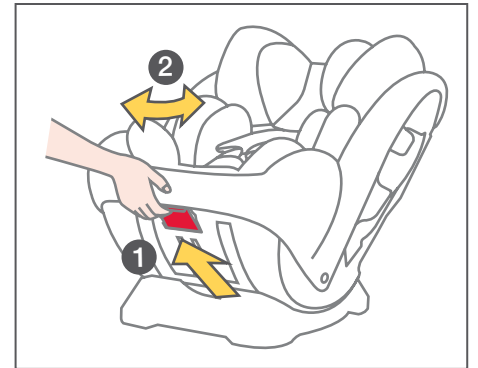
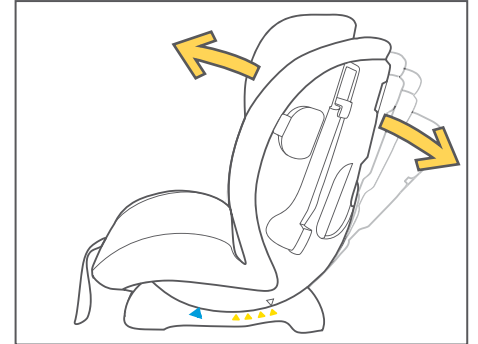

**To Adjust:**

1. Pull the release handle on the shell fully forward.

2. Rotate the shell until the white arrow is above one of the yellow arrows.





## Installation

See page 5 for recommended positions in the vehicle.

Place the restraint on the vehicle seat forward facing.

1. Pull the vehicle lap/sash belt out and thread it through the vehicle belt slots at the back of the child restraint.
2. Engage the vehicle belt buckle.

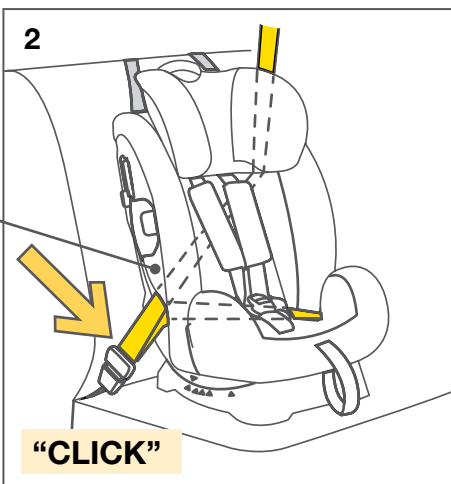
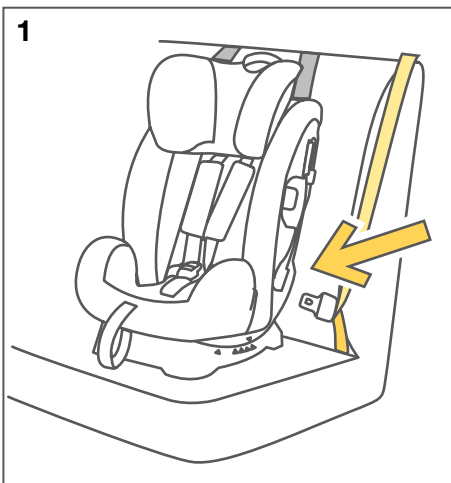

### FORWARD-FACING BELT PATH

Look for this label showing the correct path for the vehicle belts



## Installation

### FORWARD-FACING BELT PATH

Look for this marking showing the correct path for the vehicle sash belts



3. While pressing the child restraint down firmly into the vehicle seat, pull the vehicle sash belt until both lap and sash belts are tight.

4. Secure the sash belt in the belt lock off.

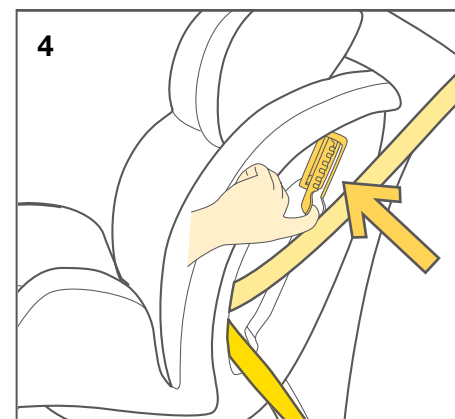
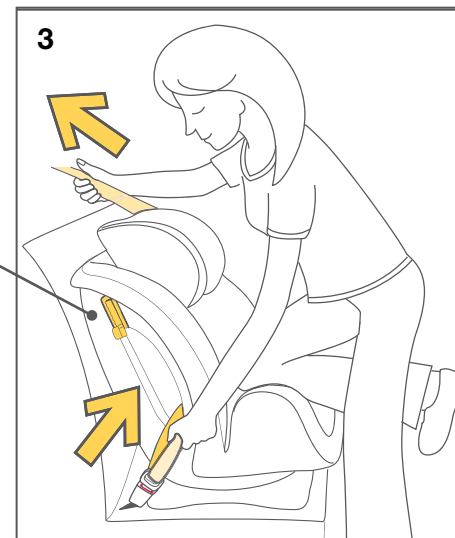

## Installation

### 5. Pull the vehicle belts tight.

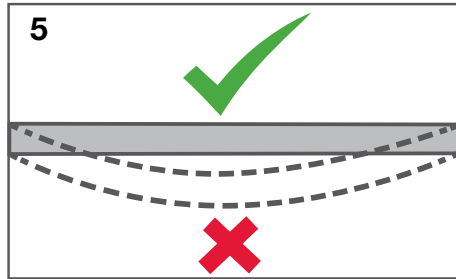

### 6. Ensure there are no twists in the belts.

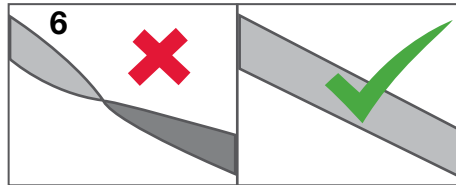

### 7. Connect the top tether strap.

NOTE: many vehicles have built-in top tether connection points. If your vehicle does not have these refer to page 22 for information on fitting the anchorage supplied.

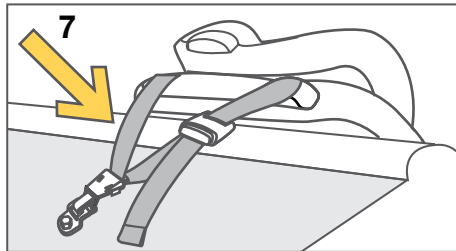

### 8. Store end of web in bag on back of cover.

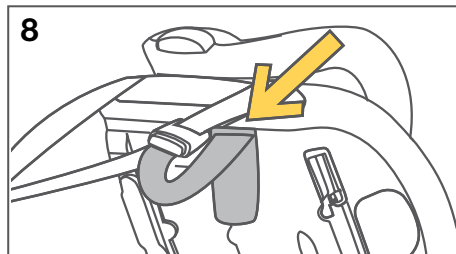

## Installation

### Tether Strap General Information

Also refer to page 21 for more Top Tether information.

Always connect the snap hook securely to the anchorage fitting.

No twists in web.

Web pulled tight.

Increase tether tension by pulling web out.

Reduce tension by pressing release button and pulling web out.

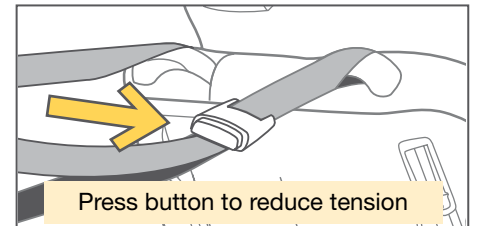
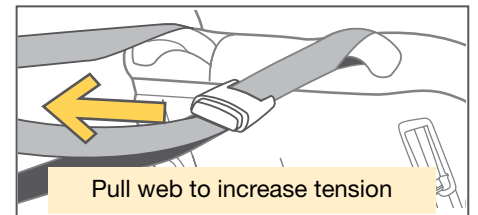
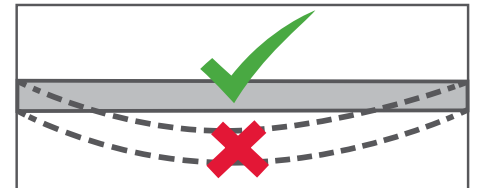
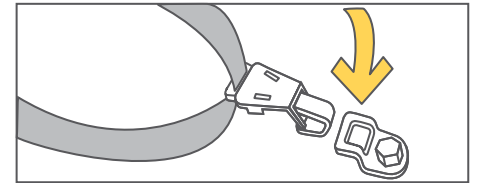

## Checklist

**Tether Strap** - securely attached to anchorage and pulled tight.  
Ensure there are no twists in the webbing.  
End of tether in storage bag

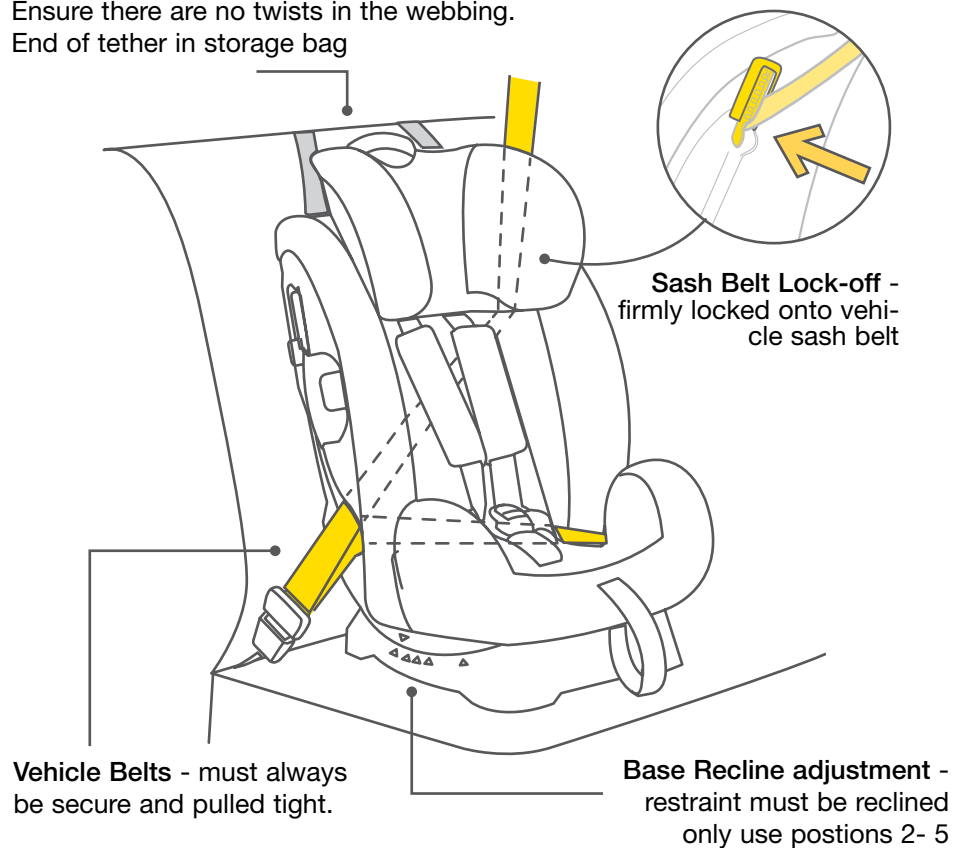

## ⚠ WARNINGS

### TOP TETHER

THIS RESTRAINT MUST BE ATTACHED TO A CHILD RESTRAINT UPPER ANCHORAGE POINT IN THE CAR.

REFER TO CAR OWNERS HANDBOOK FOR LOCATION OF UPPER ANCHORAGE POINTS.

REFER TO A CHILD RESTRAINT FITTING STATION IF NO ANCHORAGE POINTS ARE IN THE MOTOR CAR.

THIS RESTRAINT IS NOT SUITABLE FOR USE WHERE THE TOP TETHER STRAP MAY FALL INTO A SPLIT IN THE SEAT BACK OR OFF THE SIDE OF THE SEAT.

Always secure the loose end of the top tether strap to prevent it hanging out of the car or being accessible by the child. Store it in the bag attached to the back of the cover.

Do not use the child restraint where this strap may fall into a split in the seat back or off the side of the seat.

ALWAYS ATTACH HOOK AND REMOVE SLACK.

CAUTION: CHILDREN CAN BE INJURED OR RESTRAINTS AND TOP TETHER STRAP DAMAGED BY UNSECURED CARGO IN A COLLISION. SECURE OR REMOVE HAZARDOUS CARGO BEFORE USING THIS CHILD RESTRAINT.

## Top Tether - Features

This child restraint has a tether strap permanently attached to the back of the seat.

**Always use this tether strap.**

Connect the tether strap to the built-in anchorage fitting in the vehicle, or if there is not one available, install the anchor fitting supplied with this restraint by following the instructions at the end of this section.

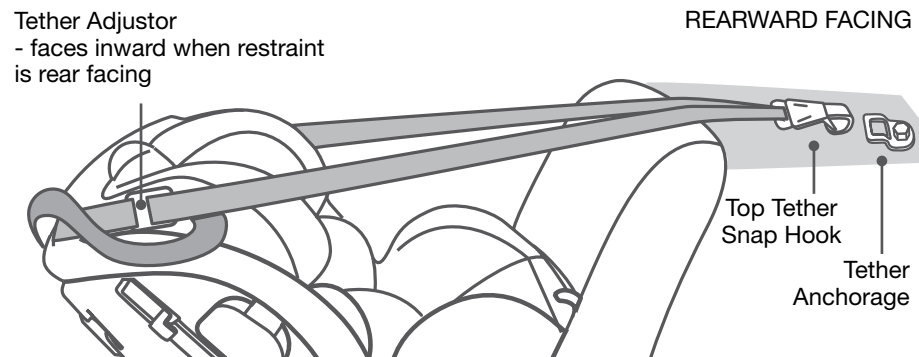
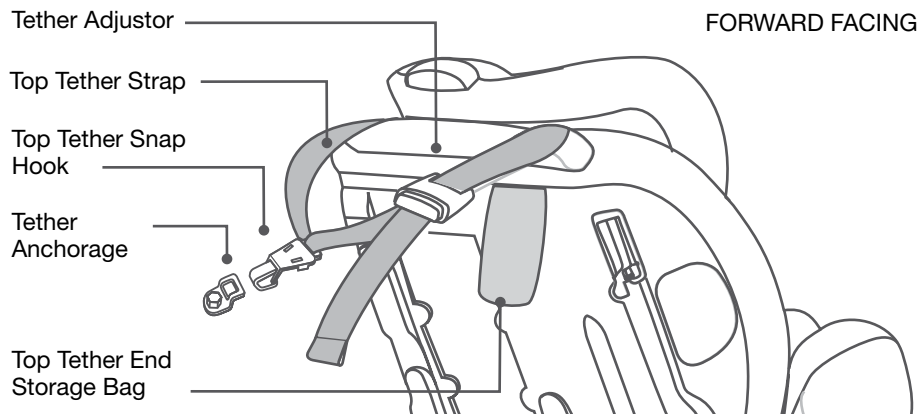

## Tether Anchorage Installation

Most cars have several threaded holes to fit the tether anchorage to.

Refer to the vehicle owners handbook for information on the location of these points.

Using the bolt provided attach the anchor fitting to the mounting point behind where the child restraint is to be installed.

See more detailed information on the next page.

The anchor fitting must be aligned as shown unless stated otherwise in the vehicle owners handbook.

If drilling a new hole, select a position on the centre line of the seating position, and no closer than 100 mm from the front edge of the parcel shelf.

The threaded hole for the anchorage bolt may have a plastic cover over it

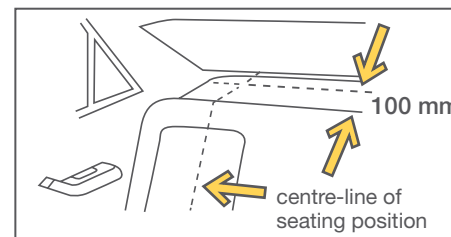
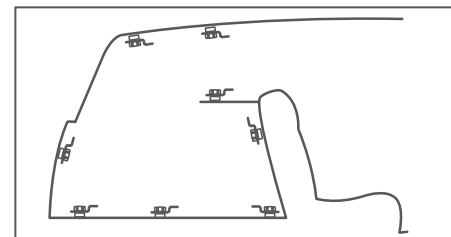
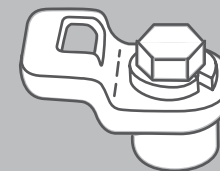

## Tether Anchorage Installation

### If the car is fitted with a child restraint anchorage point:

Locate the upper anchorage point behind the rear seating position (consult the vehicle owners handbook for location of the upper anchorage point). Remove the thread plug from the parcel shelf/floor/roof and install the attachment bolt as shown opposite.

**CAUTION:**  
DO NOT OVERTIGHTEN THE ATTACHMENT BOLT. MAXIMUM TORQUE 20Nm.

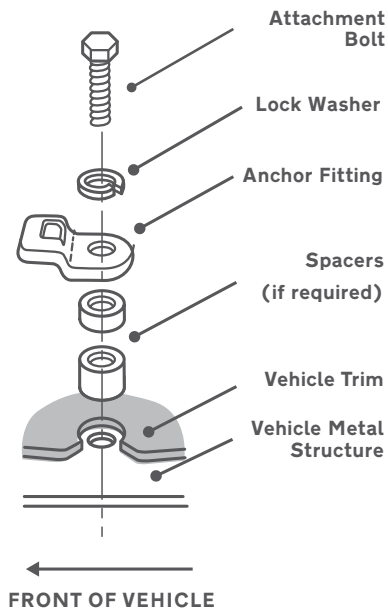

In some vehicles without a fixed parcel shelf an extension tether strap may be required. These are available in several different lengths and can be obtained from child restraint retail outlets.

## Tether Anchorage Installation

### If the car is not fitted with a child restraint upper anchorage point:

For sedans only - drill a 9 mm hole in the parcel shelf on the centre line of the seating position as shown on page 22. Install the anchor bolt as shown opposite.

It is recommended that this installation be carried out by a child restraint fitting station or licenced motor mechanic.

For vehicles other than sedans:

In Australia, consult your nearest child restraint fitting station or traffic authority for vehicle inspection to find the best, correct position for the placement of the upper anchorage point, and for the correct attachment bolt length and use of spacers.

In New Zealand, consult the agent for the vehicle.

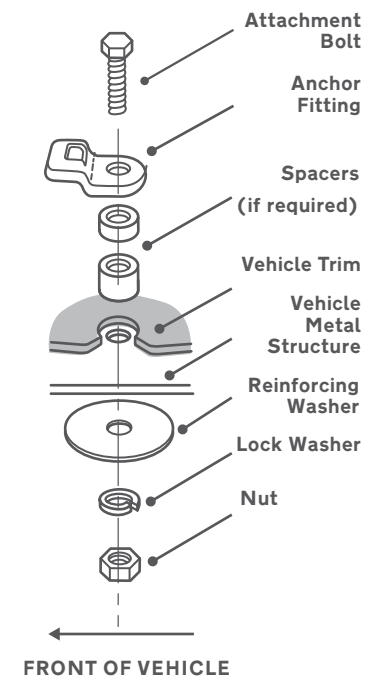

### WARNING

CHILD RESTRAINTS MUST NOT BE ATTACHED TO UNSOUND METAL OR WOOD OR SYNTHETIC STRUCTURES. WHEN DRILLING THE 9 MM HOLE DO NOT DRILL THROUGH FUEL LINES, FUEL TANKS, ELECTRICAL WIRING, OR RADIO SPEAKERS. WEBBING STRAPS MUST BE PROTECTED FROM SHARP CORNERS AND EDGES.

THE ANCHOR FITTING MUST BE USED ONLY AS DESCRIBED ABOVE. IT MUST NOT BE HOOKED ONTO ANY OTHER OBJECT.

SEAT COVER

Wash with cold water at less than 30

degrees C.

Do not iron.

Do not bleach or dry clean.

Do not twist the soft goods to dry with

great force. It may leave the seat cover with

wrinkles.

Hang dry the seat cover in the shade. Do

not tumble dry.

PLASTIC AND METAL PARTS

Use only mild detergent, water and a soft

cloth to clean the car seat shell, handle

and harness straps. Air dry.

Do not use undiluted detergent, or other

solvents to clean - these may cause

damage.

HARNESSTRAPS

Shoulder harness straps are not remov-

able.

Clean with mild detergent, water and a

soft cloth only.

HARNESSTRAP BUCKLE

To clean the buckle: rinse using warm

water. DO NOT use any soaps, solvents

or lubricants. Using anything other

than water can cause the buckle to

malfunction. Air dry.

When the buckle is operating correctly the

tongues will push in easily and the second

tongue will CLICK when it latches into

place.

If the buckle does not appear to be

working correctly get it checked or

replaced by contacting the retailer from

where it was purchased, or by contacting

Australia's Power Brands.

STORAGE

Remove the child restraint from the vehicle

seat if not in use for a long period of time.

Put the child restraint in a cool, dry place

where your child cannot access it.

Refit Cover

To Refit

Seat Cover

1. Place the main cover into the seat.
2. Thread the QR buckle through the slot in the cover, and move the harness lap straps into the slots in the cover.
3. Secure the press studs inside and outside the shell.
4. Replace the infant insert and crotch pad if using these items.

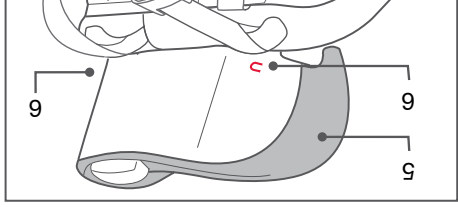

Headrest Cover

5. Pull the headrest cover over the headrest from the front.
6. Locate the elastic loops and thread to these under the headrest and reattach to the lugs at the back of the headrest.

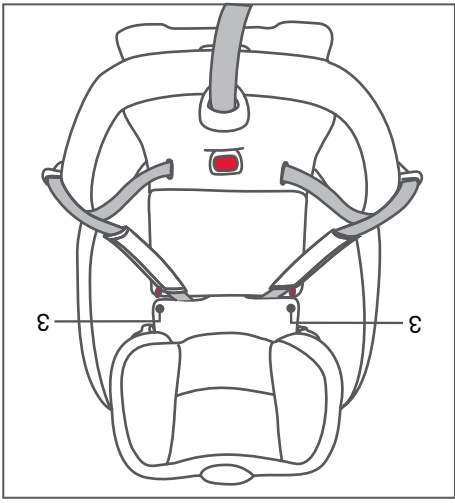
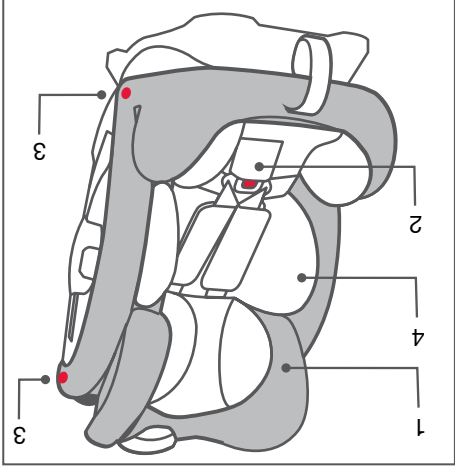

The Next Restraint

This restraint is suitable for a child of average size up to approximately four years of age.

When the child has outgrown this restraint, the next suitable types of restraint are a bigger harnessed seat or a booster seat.

Some harnessed seats are suitable for children up to approximately 8 years of age.

Booster seats are available for children up to approximately 8 or 10 years of age.

Illustrated: Joie Trillo

**IMPORTANT:** Children are at risk of serious injury if they move to booster seats too early.

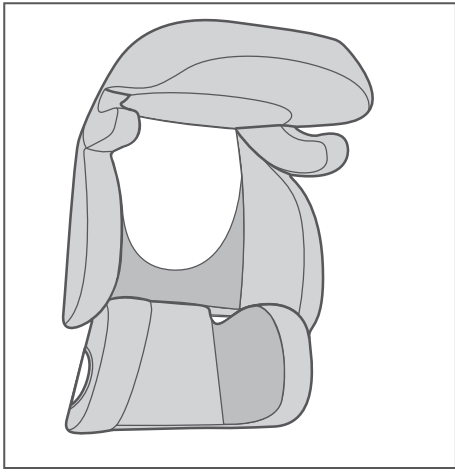
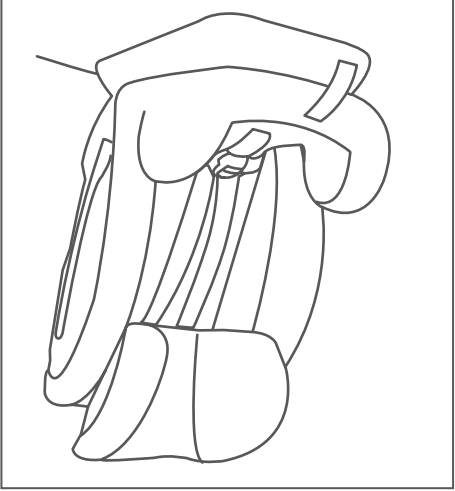

## Checklist

Shoulder Straps - must always be at correct height and pulled tight.

Head Liners and Infant Insert - only use for smaller children who require more support.

Harness Straps - must not be twisted.

Shoulder Height - shoulders must not be above the upper marker line

Quick Release Buckle - must always be securely fastened.

Recline angle - use positions 2 - 5. Do not use position 1.

Suitable clothing - child's clothing must allow the harness to securely grip the child.

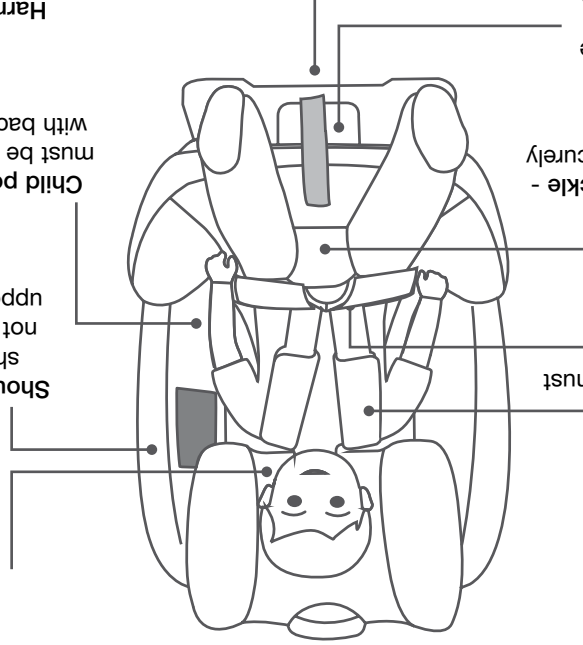

Harness Tension - pull harness tight.

Child position - child must be in full contact with back of restraint.

## Cover Removal

To Remove

1. Remove the Infant Insert, Shoulder Pads and Crotch Pad if fitted.

Headrest cover

2. Detach elastic loop fasteners at back of headrest and remove the head support cover by pulling forward over the headrest.

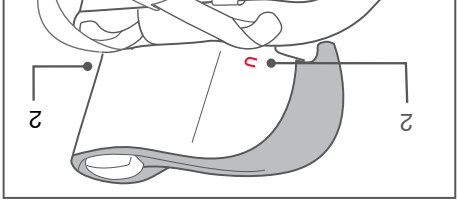

Seat Cover

3. Press the red button down to disengage the QR buckle and remove webbing and spread outwards,

4. Detach the press studs on sides of seat pad.

5. Detach the press studs inside the cover.

6. Pull the QR buckle through the slot in the seat pad and then remove seat pad from seat shell.

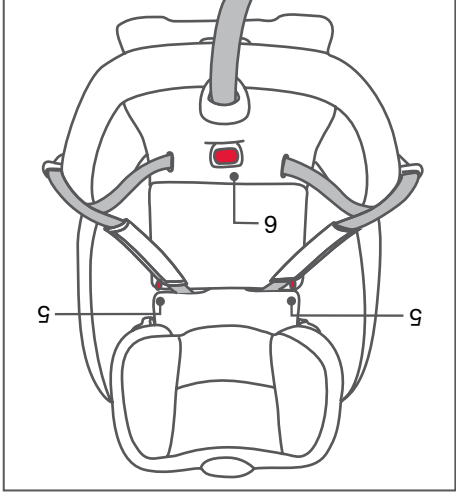
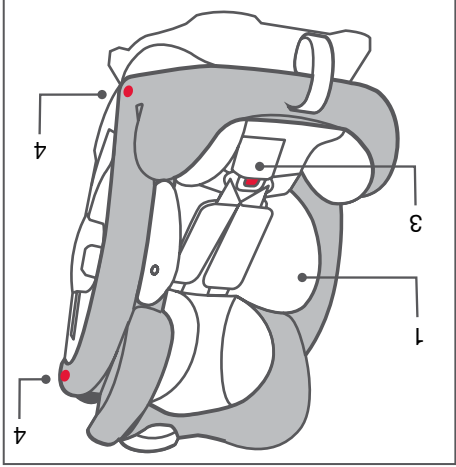



5. Make sure there are no twists in the straps.

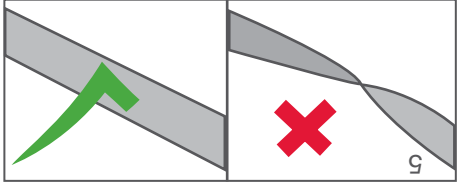

6. Recheck shoulder strap height.

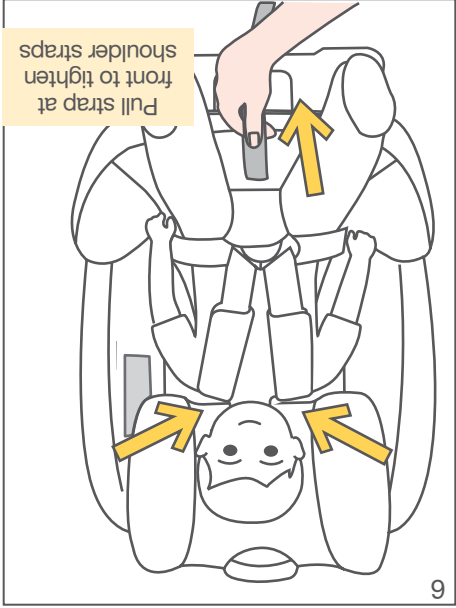

Pull strap at front to tighten shoulder straps

7. Tighten harness by pulling on the adjuster strap at the front of the restraint. Note: the lower harness webbing may not pull freely through the harness buckle tongues. You may need to pull the webbing through the buckle tongues up towards the child's shoulder then pull on the adjuster strap. This may need to be repeated several times to get the webbing fitting snugly.

**DO NOT LEAVE CHILDREN UNATTENDED IN THE CAR**

**WARNING**

**Securing a Child in the Restraint - Adjusting the Harness**

8. Correct strap tension. Put a finger under each strap and pull gently outwards. There should be no gap between your finger and the child.

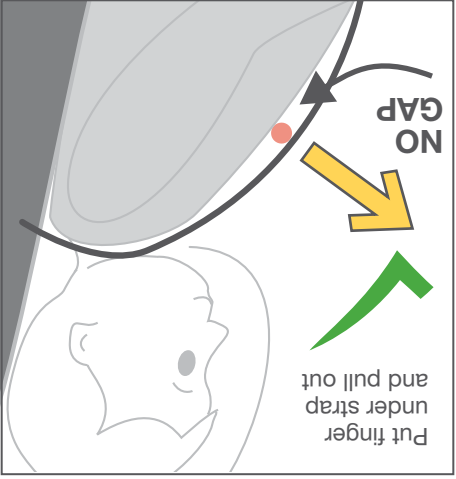

Put finger under strap and pull out

There should be no gap between your fin-

ger and the child.

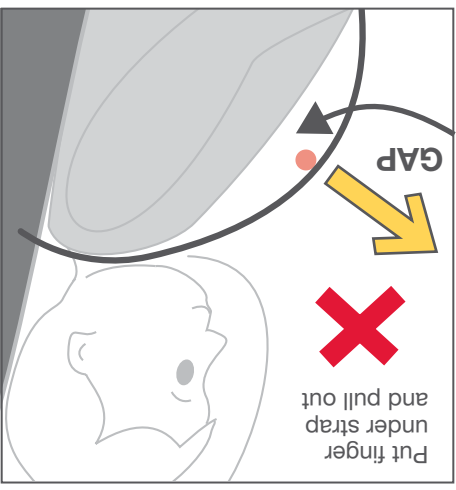

Put finger under strap and pull out

GAP

**Securing a Child in the Restraint - Adjusting the Harness**

## Securing a Child in the Restraint - Securing the Harness

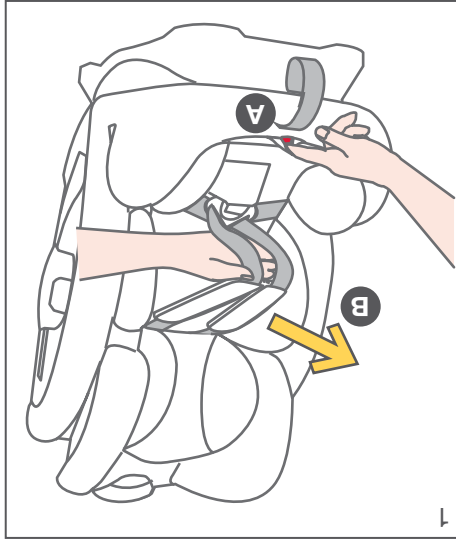

- FIRST CHECK SHOULDER STRAP HEIGHT AND ADJUST IF NECESSARY.
- 1 Loosen harness by pressing on adjuster button A while pulling on the harness straps B.

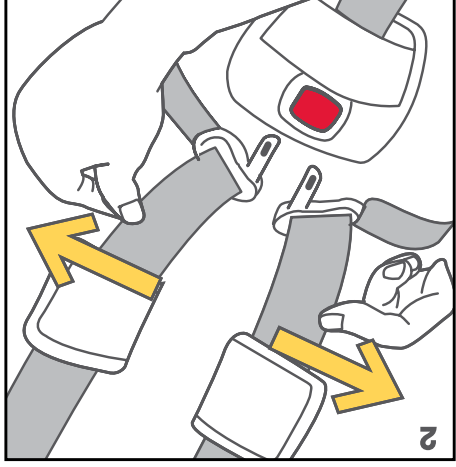

- 2 Press button to open the quick release buckle.
- Spread harness straps apart.

## FORWARD FACING USE

21

## Securing a Child in the Restraint - Securing the Harness

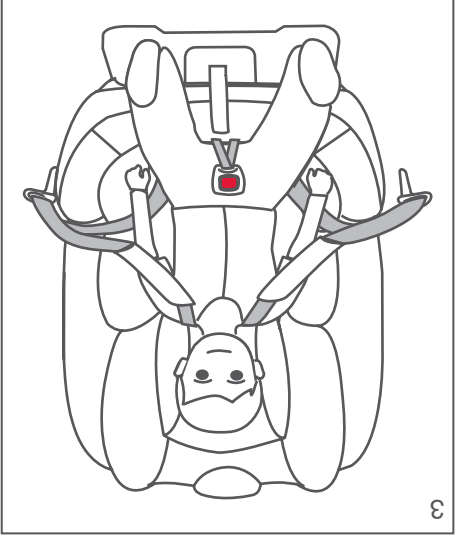

- 3 Place child in restraint in seated position firmly against both the back and bottom of the restraint.

**IMPORTANT**  
Children need to be securely held by the harness. Children must be dressed in clothing that allows the harness to firmly grip them. Do not wrap the child in a blanket or similar. Only place such covering over the child after they are strapped in.

- 4 Place buckle tongues into the quick release buckle.

**IMPORTANT:**  
The buckle tongue pushed in last should "CLICK" when it locks into place. If it does not click, try again or try cleaning the buckle.

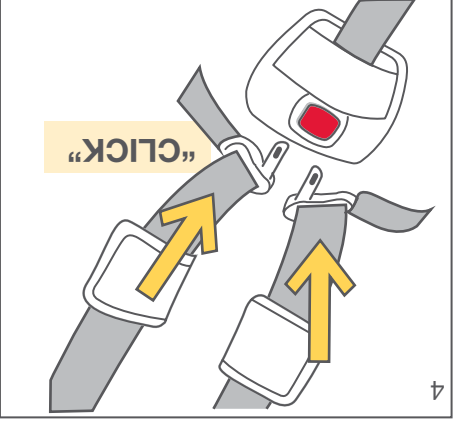

22

## FORWARD FACING USE

## Securing a Child in the Restraint - Shoulder Strap height labels

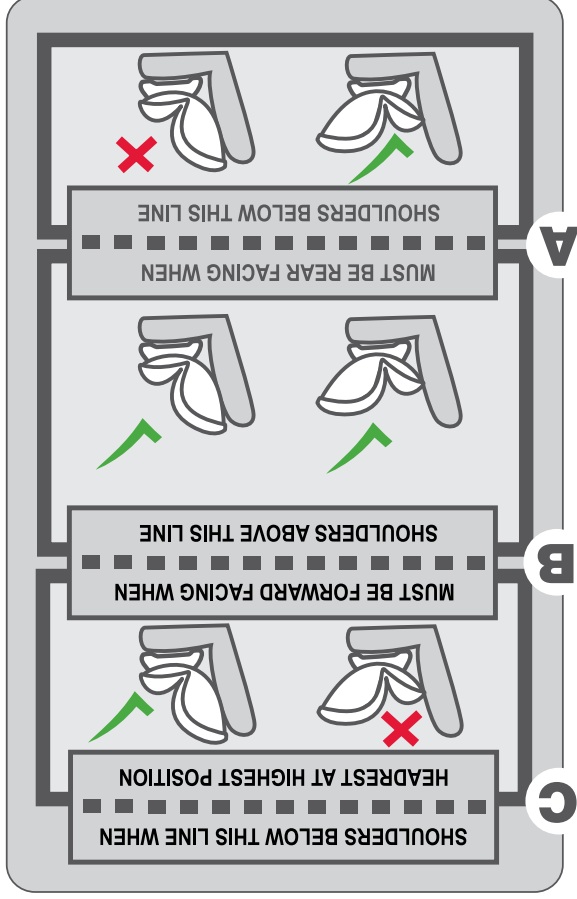

IMPORTANT: Joie recommends that children remain rear facing until their shoulders reach line B.

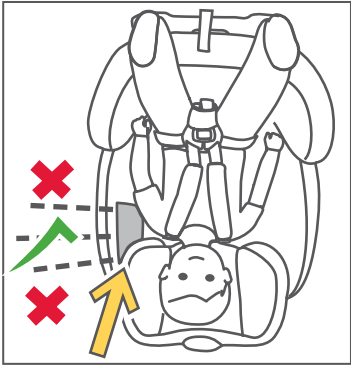

This restraint has a shoulder height level label. Use this label to decide if the restraint should be rear or forward facing. If your child's shoulders are below the bottom dotted line **A** the restraint must be rearfacing. Once your child's shoulders pass the line **A** they can be either rearfacing or forward facing. Once your child's shoulders reach the dotted line **B** the restraint must be forward facing. Once your child passes line **C** they are too big for this restraint and need to move to a Booster Seat.

## Securing a Child in the Restraint - Shoulder Strap height

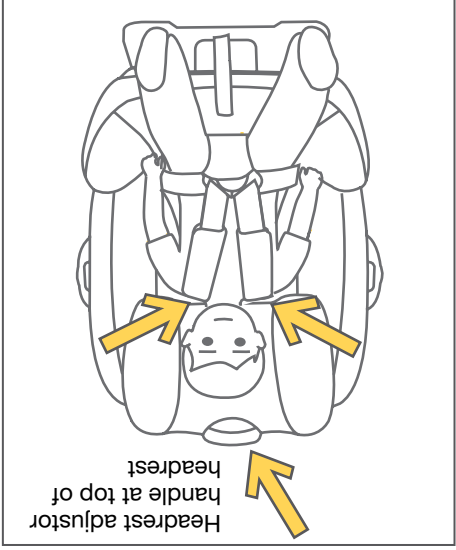

Correct positioning of the shoulder straps is essential for your child's safety.

**Requirement:** The shoulder straps must be positioned near to the child's shoulders, but not more than 25 mm below the child's shoulders.

Note: the shoulder strap height requirement for forward facing is different to rear facing.

**To Check:** With child placed in the restraint, note where the shoulder straps are positioned relative to the shoulders.

**To Adjust:** If adjustment is needed squeeze the headrest adjuster handle and raise or lower the headrest and shoulder straps as required.

IMPORTANT: Always adjust the height of the shoulder straps as the child grows

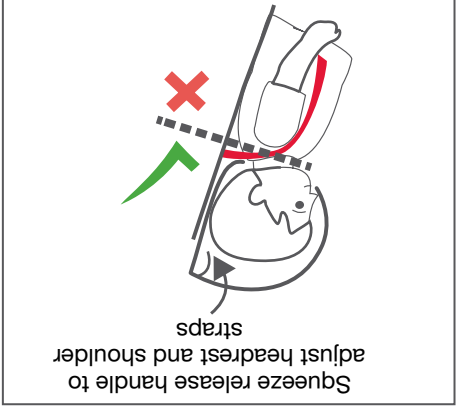

**Forward Facing**

The liner should be used for small children only.  
 It should be removed when they grow older than about 6 months.  
 DO NOT use the liner if the child is so big that it is preventing them having some movement.

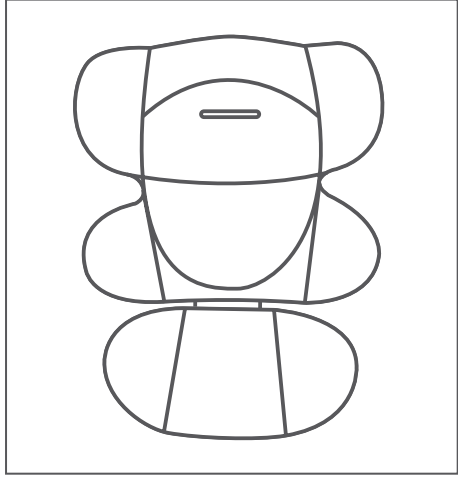

**Liner**



**Correct Recline Angle**

When used forward facing the restraint must always be correctly reclined. The white arrow on the shell must be above one of the yellow arrows on the base. Select a position that gives the most comfort for your child.

**IMPORTANT**  
 A correct recline angle is essential for your child's safety.

DO NOT use position 1 marked by the blue arrow when the restraint is forward facing.

**To Adjust:**

1. Pull the release handle on the shell fully forward.

2. Rotate the shell until the white arrow is above one of the yellow arrows.

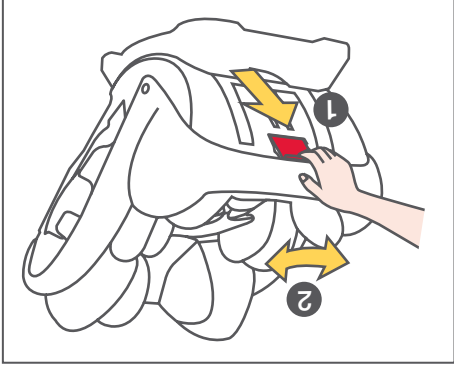
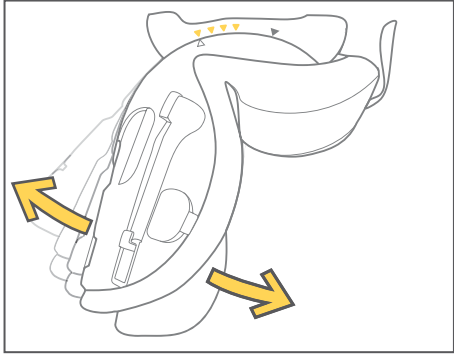

**Securing a Child in the Restraint - Recline Angle**



## Checklist

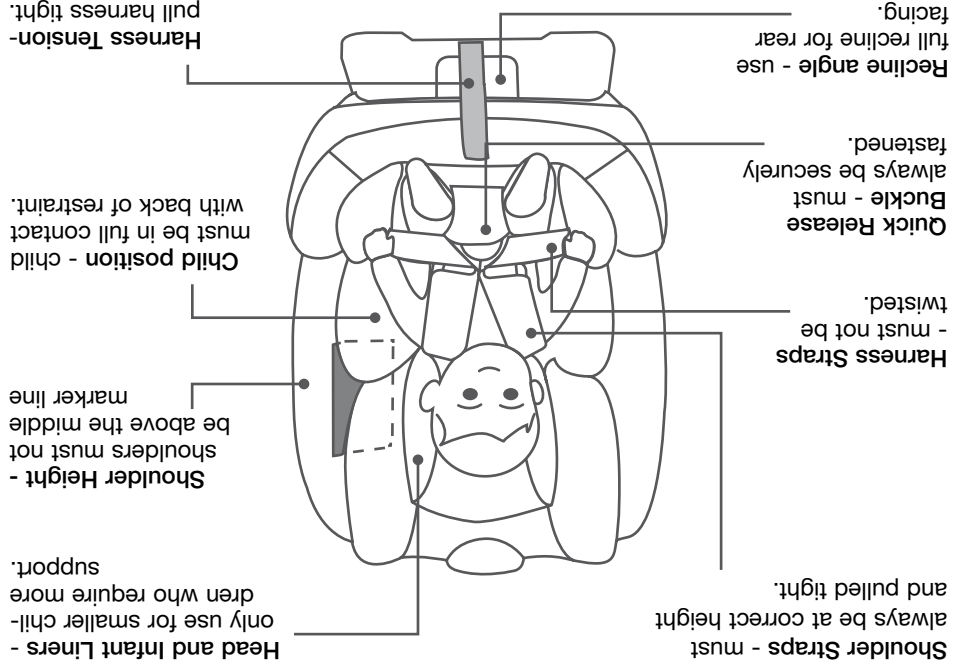

**Suitable clothing - child's clothing must allow the harness to securely grip the child.**

## REAR FACING USE

## Liner

**Rear Facing**  
This restraint has a soft padded liner for use with a baby or small child. Use this liner for more comfort or if they are not fully supported by the main cover.

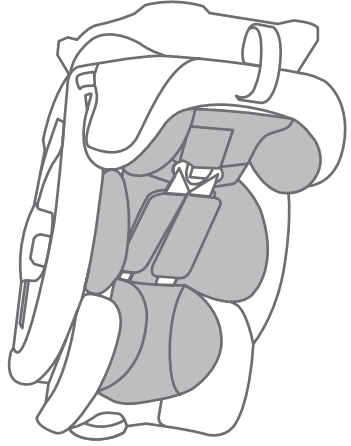

**Removable Head Support**  
The head support is attached to the main liner by snaps and can be removed. Remove the head support when the child's head no longer fits comfortably inside the headrest.

The body portion of the liner can be used separate from the head support.

**Shoulder, Lap and Crotch pads.**

These are for comfort only and can be removed at any time.

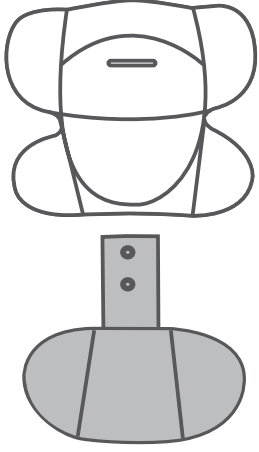

## REAR FACING USE

## Securing a Child in the Restraint - Using the Harness

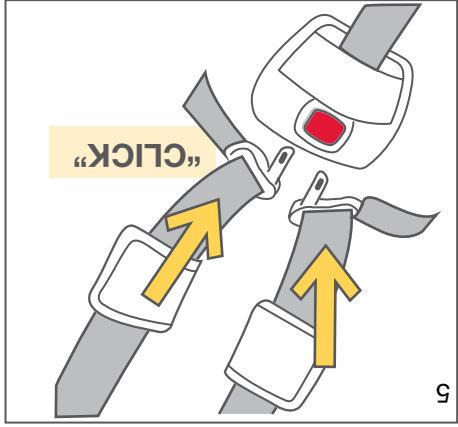

5. Place buckle tongues into the quick release buckle.

**IMPORTANT**  
The buckle tongue pushed in last should "CLICK" when it locks into place. If it does not click, try again or try cleaning the buckle.

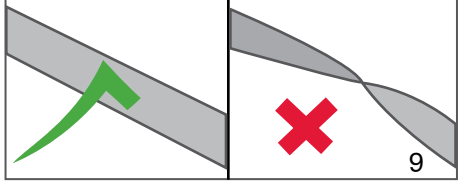

6. Make sure there are no twists in the straps.

7. Recheck shoulder strap height.

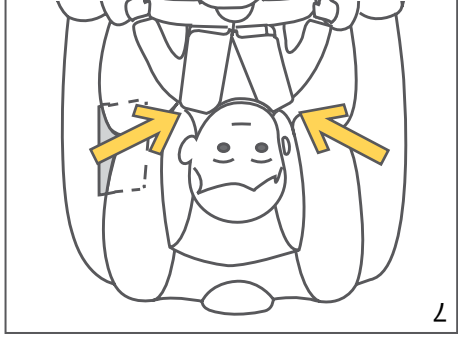

**WARNING**  
DO NOT LEAVE CHILDREN UNATTENDED IN THE CAR

## Securing a Child in the Restraint - Adjusting the Harness

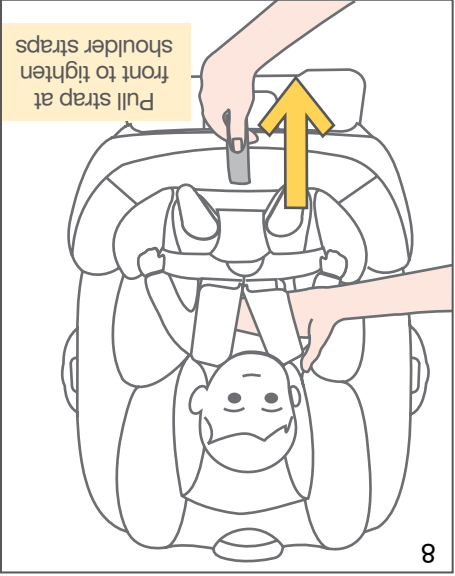

8. Tighten harness by pulling on the adjuster strap at the front of the restraint. Shoulder straps should be a snug fit.

Note: sometimes the straps may be loose in the lap part of the harness.

You may need to pull loose straps through the buckle tongues upward towards the child's shoulder and then pull again on the adjuster strap.

This may need to be repeated several times to get a snug fit.

9. Correct strap tension. Put a finger under each strap and pull gently outwards.

There should be no gap between your finger and the baby.

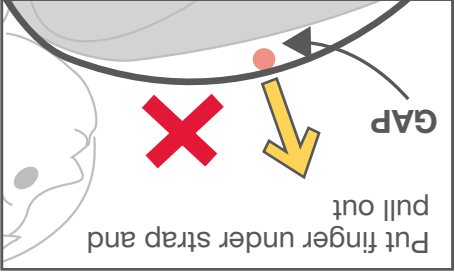
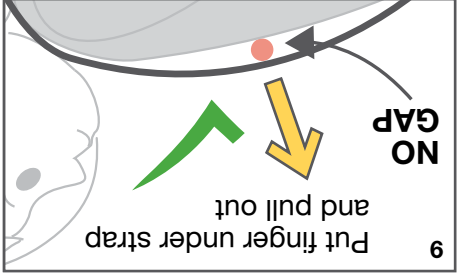

## Securing a Child in the Restraint - Using the Harness

FIRST CHECK SHOULDER STRAP, HEIGHT AND ADJUST IF NECESSARY.

See page 11.

1. Loosen harness by pressing on adjuster button A while pulling on the harness straps B.

2. Press button to open the quick release buckle. Spread harness straps apart.

### IMPORTANT

Infants need to be securely held by the harness. An infant wrapped in a blanket or swaddled will not be securely held and may be ejected and killed in an accident. The harness needs to fit the infant securely. Only place any blanket or other covering over the harness after it is adjusted. Do not bind or wrap the infants arms or legs together.

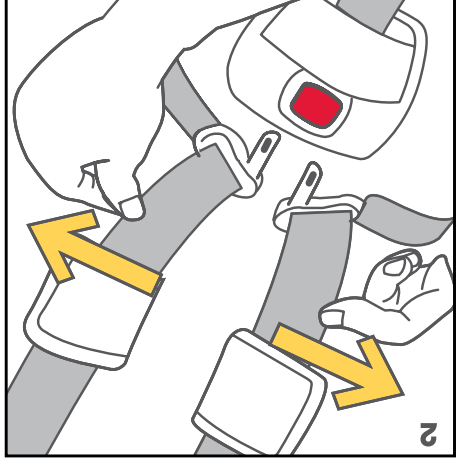
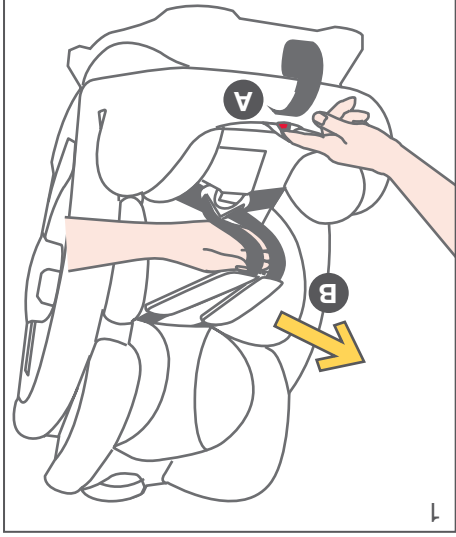

## Securing a Child in the Restraint - Using the Harness

3. Place child in restraint in seated position.

IMPORTANT:  
Child must be dressed in clothing that allows the harness to firmly secure them.

4. Child must be placed firmly against both the back and bottom of the seating surface.

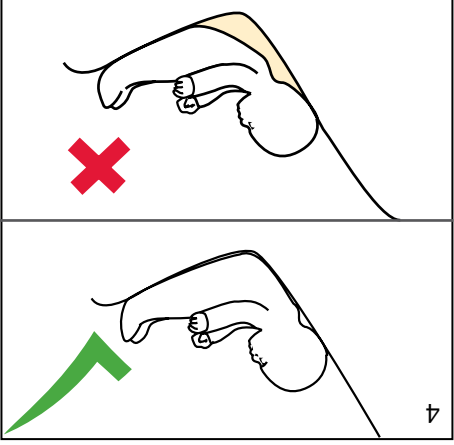
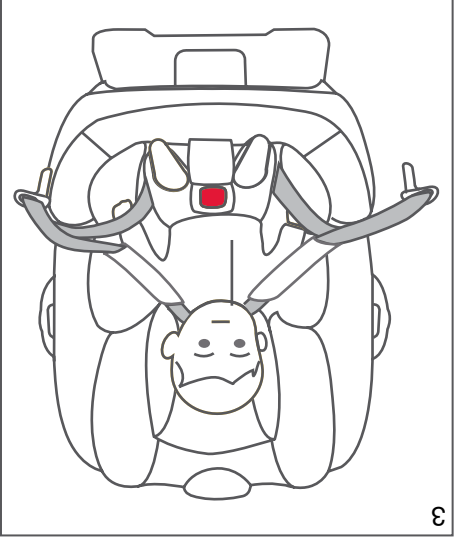

## Securing a Child in the Restraint - Shoulder Strap height labels

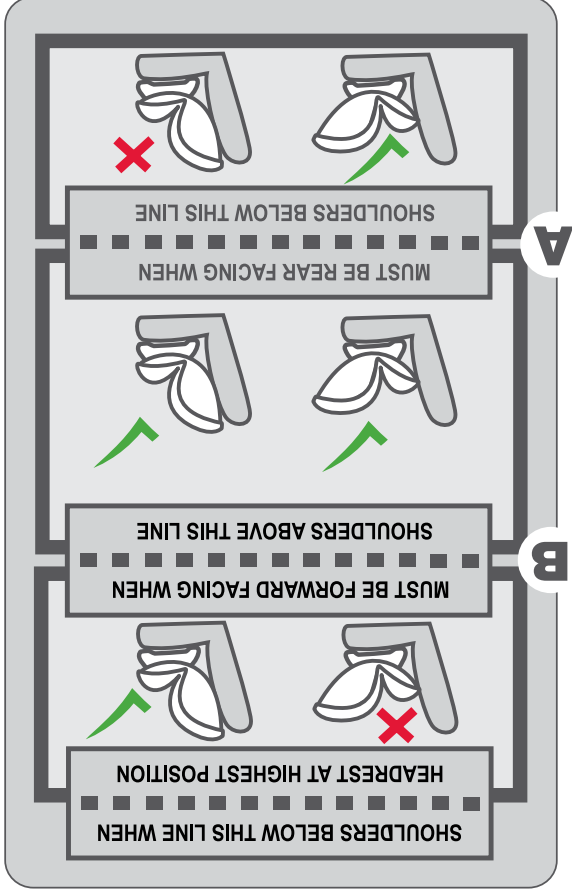

This restraint has a shoulder height level label. Use this label to decide if the restraint should be rear or forward facing. If your child's shoulders are below the bottom dotted line **A** the restraint must be rearfacing. Once your child's shoulders pass the line **A** they can be either rear-facing or forward facing. Once your child's shoulders reach the dotted line **B** the restraint must be forward facing. See page 19 for information about forward facing use.

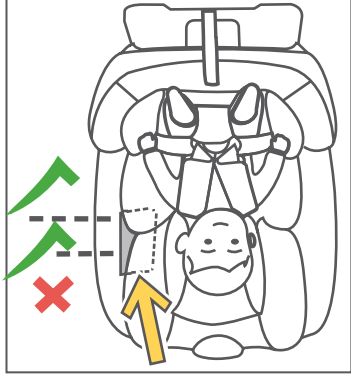

**IMPORTANT:** Children are safer rear facing. Joie recommends that they remain rear facing until their shoulders reach line B

## Securing a Child in the Restraint - Shoulder Strap height

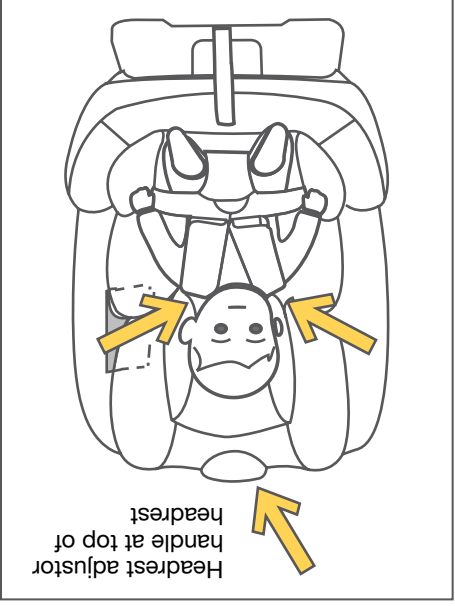

Headrest adjuster handle at top of headrest

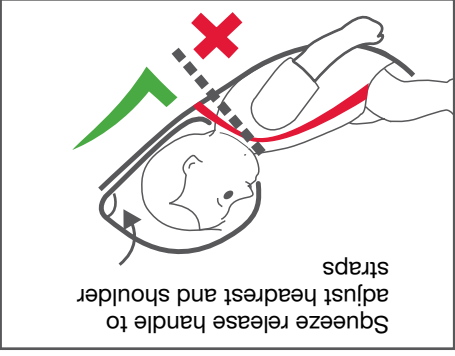

Squeeze release handle to adjust headrest and shoulder straps

Correct positioning of the shoulder straps is essential for your baby's safety.

**Requirement:** The shoulder straps must be positioned near to the child's shoulders, but not lower than the child's shoulders. The straps should be in the next available adjustment position above your child's shoulders.

Note: the shoulder strap height requirement rear facing is different to forward facing.

**To Check:** With baby placed in the restraint, note where the shoulder straps are positioned relative to the shoulders.

**To Adjust:** If adjustment is needed squeeze the headrest adjuster handle and raise or lower the headrest and shoulder straps as required.

**IMPORTANT:** Always adjust the height of the shoulder straps as the child grows

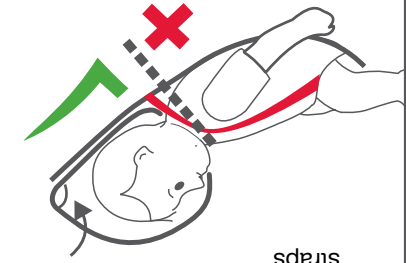



## Features

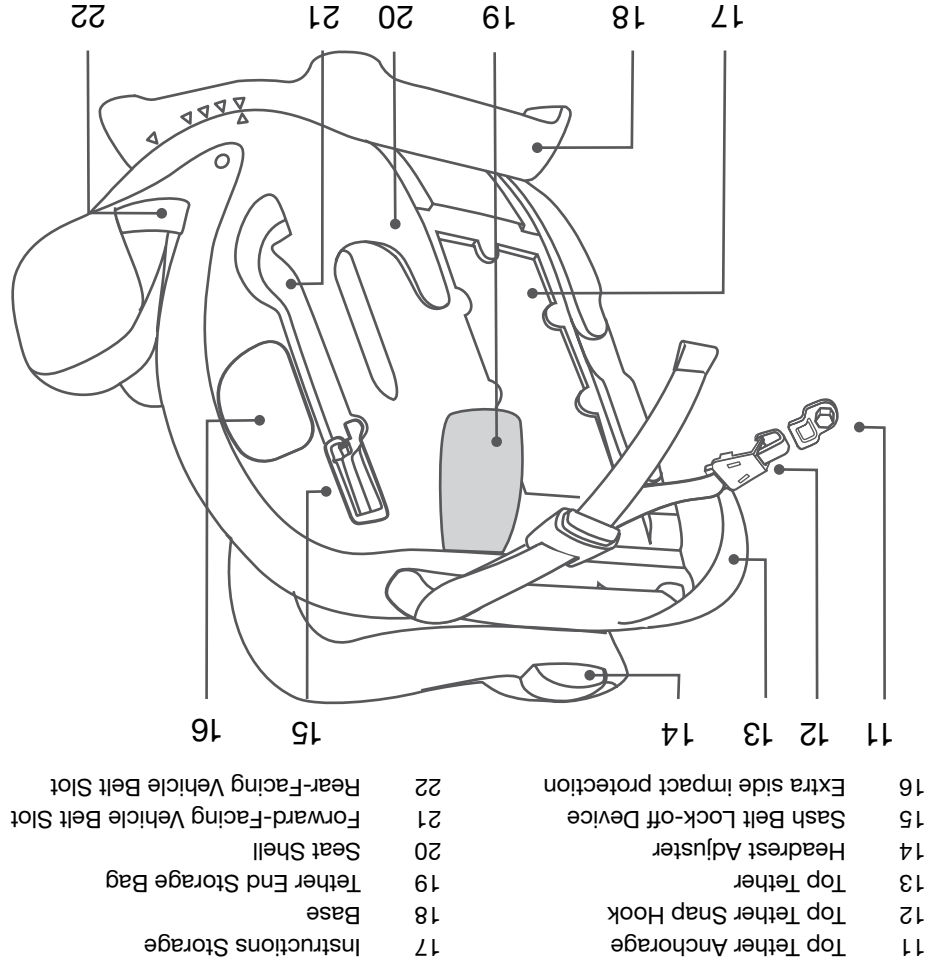

## Securing a Child in the Restraint - Recline Angle

This restraint should be installed in the rear seat. See installation instructions.

### Correct Recline Angle

When used rear facing the restraint must always be fully reclined. The white arrow on the shell must be above the blue arrow on the base.

**IMPORTANT:** A correct recline angle is essential for your baby's safety.

### To Adjust:

1. Pull the release handle on the shell fully forward.

2. Rotate the shell until the white arrow is above the blue arrow.

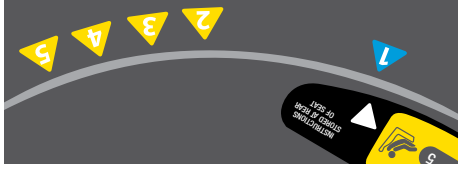
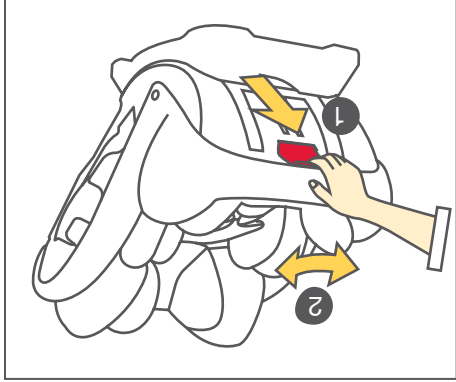
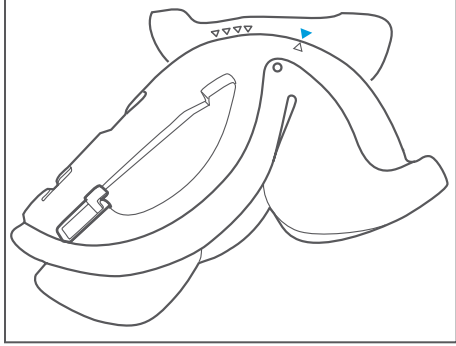

**Features**

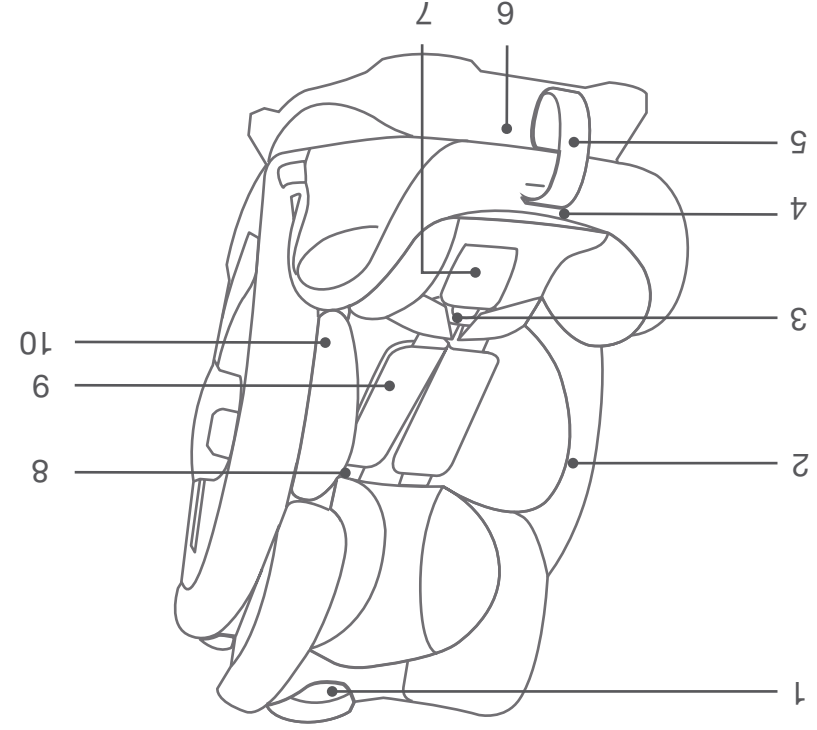

- 1 Headrest height Adjustor
- 2 Seat Cover
- 3 Harness QR Buckle
- 4 Harness Adjuster (under cover)
- 5 Harness Adjuster Webbing
- 6 Recline Angle Adjustment Handle
- 7 Crotch Pad
- 8 Shoulder Harness Strap Cover
- 9 Shoulder Harness Strap Cover
- 10 Infant Body Support

**ADDITIONAL WARNINGS**

Only install child restraint in a forward facing vehicle seat. Never install in a seat that faces the rear or the side of the vehicle.

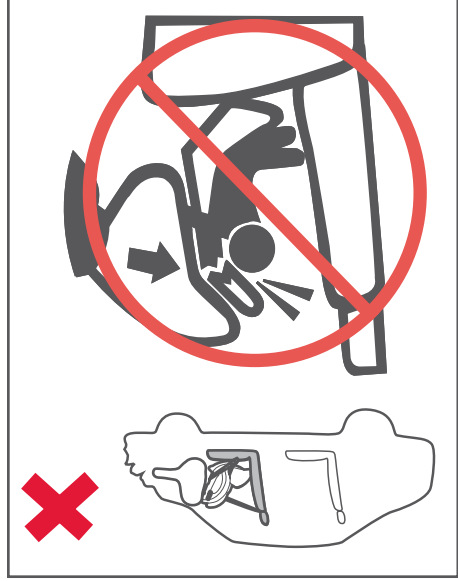
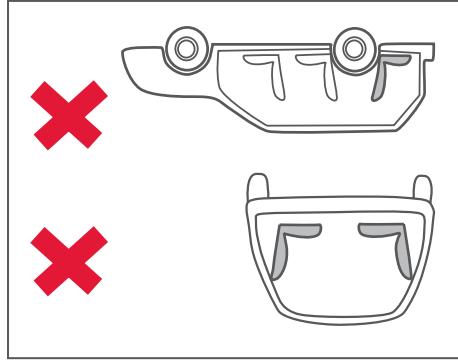

Never install the Child Restraint in a seat with a front airbag. DEATH or SERIOUS INJURY may occur. Refer to your vehicle Owners Manual for airbag warnings and information.

**⚠ WARNINGS**

**GENERAL WARNINGS**

- Use the restraint exactly as shown in the instructions.
- Supervision of children is needed because they may be able to undo buckles.
- A loose harness or restraint is dangerous.
- Fit the harness firmly to the child.
- DO NOT USE THIS RESTRAINT WITHOUT THE COVER
- DO NOT LEAVE CHILDREN UNATTENDED IN THE CAR

**REAR FACING WARNINGS**

- To ensure that infant's back is evenly supported, do not put more than one nappy on the baby and make sure the nappy is not folded thickly at the back.
- DO NOT USE A REAR FACING CHILD RESTRAINT WHERE AN AIRBAG IS FITTED IN FRONT OF THE SEATING POSITION.
- Do not harness an infant wrapped in a blanket or swaddled. Any blanket or wrap must only be placed over the harness and infant.

**VERY IMPORTANT: Only replace the cover with a Joie supplied replacement cover with identical shoulder height markers or a replacement cover meeting AS/NZS 8005.**

NOTE: The warnings on this page are required by the Australian and New Zealand Standard AS/NZS 1754 for this type of child restraint. Other warnings specific to this particular child restraint will be found on the following pages and throughout these instructions.

**ADDITIONAL WARNINGS**

This Child Restraint is: **To be used only in a rearward-facing position until the infant's shoulders either reach the lower shoulder height marker (approximately 12 months of age) or reach the middle height marker (approximately 2 to 3 years of age).** Then to be used in a forward-facing position until the child's shoulders reach the upper shoulder height marker (approximately 4 years of age).

Continue to use this child restraint until the child reaches this limit.

Do not use forward facing until child's shoulders are above the lower shoulder height marker.

Infants are at risk of serious injury if they face forward too early.

Children are at risk of serious injury if they move to booster seats too early.

Children who have outgrown this restraint are safest in a larger child restraint with an in-built harness, or a booster seat until their shoulders reach the upper shoulder height marker of the restraint.

Ensure that children have adequate ventilation and shade when in the vehicle.

Strangulation hazard: Child can strangle in loose restraint straps. Always use harness. Never leave child in restraint when straps are loose or undone.

Follow the instructions for use of the liner.

Aftermarket accessories (i.e. items not provided in the box with the child restraint), may not have been tested for use with this child restraint and if used, may lower the level of protection offered possibly leading to injury or death.

Any aftermarket accessory used should be compliant with AS/NZS 8005 (Accessories for child restraints for use in motor vehicles) and stated as suitable for use with this child restraint.

# CONTENTS

<b>WARNINGS</b> .....	3
ADDITIONAL WARNINGS .....	4 & 5
Features.....	6 & 7
<b>REAR FACING</b>	
Recline Angle .....	8
Shoulder Strap Height Labels .....	9
Shoulder Strap Height .....	10
Using the harness .....	11 - 13
Adjusting the Harness .....	14
CHECKLIST .....	15
Liner .....	16 & 17
<b>FORWARD FACING</b>	
Recline Angle .....	18
Shoulder Strap Height Labels .....	19
Shoulder Strap Height .....	20
Securing the Harness .....	21 & 22
Adjusting the Harness .....	23 & 24
CHECKLIST .....	25
Cover Removal & Refit .....	26 & 27
The Next Restraint .....	28
Maintenance .....	29

**IMPORTANT:**  
Before installation and use of this child restraint check that it is suitable for the size of your child.  
Refer to the shoulder height label information on pages 9 and 19.

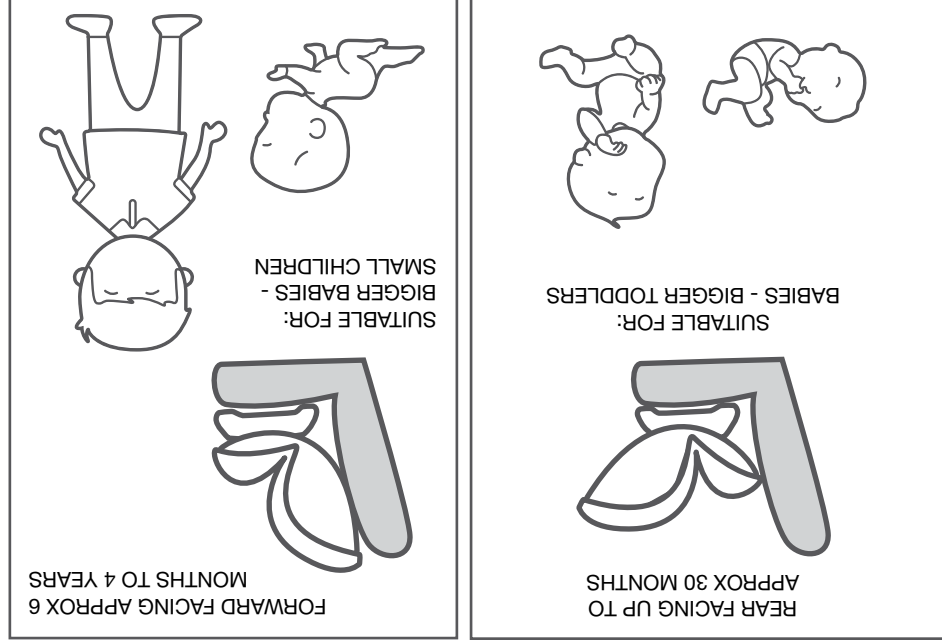

**DO NOT USE THIS CHILD RESTRAINT UNTIL YOU HAVE READ AND UNDERSTOOD THE INSTRUCTIONS IN THIS USER GUIDE AND IN YOUR VEHICLE OWNERS MANUAL**