

Joie™

Instruction Manual

basil™ 2-in-1

belt-positioning booster

Height: 110 - 152 cm (43 - 60 in.)

Weight: 18 - 54 kg (40 - 120 lb.)



IMPORTANT!

Read all instructions before assembling and using the car seat.
Keep instructions for future use.

Contents:

- 3 Important
 - Welcome to the Joie Family!
 - If You Need Help
 - Register Your Child Restraint
- 5 Child Requirements
- 6 Warnings
- 12 Best Practices
- 13 Vehicle Compatibility
- 14 Vehicle Belts
- 16 UAS and Vehicle Belt Overview
- 18 Install Requirements
- 20 Parts List
- 22 Booster Assembly
- 24 Head Support Adjustment
- 26 **Install Highback Booster**
- 30 **Install Backless Booster**
- 34 Removing/Storing Lower Anchor Attachments
- 36 Cup Holders
- 38 Removing Softgoods
- 40 Care and Maintenance

Important:

Welcome to the Joie Family!

Ensure your child's safety – **READ THIS MANUAL CAREFULLY!**
Although no child restraint can promise to protect in every situation, using it correctly reduces the chance of serious injury. Even if the child restraint seems easy, follow the step-by-step instructions in this book.

Store this instruction manual in the compartment located on the bottom of the child restraint base.

If You Need Help

If you have questions about parts, use, or maintaining your child restraint, contact our Consumer Service Department for assistance. To ensure a speedy response, please have your child restraint's model number and date of manufacture ready. You can find the information on a sticker located on the underside of the child restraint.

JOIE Bébé Canada Consumer Service Contact Info.

Address: PO Box 96528 RPO Brunswick,
Kirkland, Quebec H9H 5L4

Email: info.us@joiebaby.com

Phone: 1-866-798-7866

Important:

Register this Child Restraint

Child restraints could be recalled for safety reasons. You must register this restraint to be reached in a recall. Send your name, address, e-mail address if available, and the restraint's model number and manufacturing date to **JOIE Bébé Canada, PO Box 96528 RPO Brunswick, Kirkland, Quebec H9H 5L4**, call **1-866-798-7866**, or register online at:

www.joiebaby.com/us/register-car-seat

For recall information, call Transport Canada at 1-800-333-0371 or go to www.tc.gc.ca

For future reference, record the following information about your child restraint in case you move, lose your registration card, or need to reference it for any reason. You can find this information on the registration card or on the manufacturer label located on the child restraint:

Model Name:

Model Number:

Date of Manufacture:

Date of Purchase:

Child Requirements:

This child restraint is for a child that meets the following requirements:

Highback Booster

Weight: 18 - 50 kg (40 - 110 lb.)

Height: 110 - 145 cm (43 - 57 in.)

At least 4 years old

Backless Booster

Weight: 23 - 54 kg (50 - 120 lb.)

Height: 110 - 152 cm (43 - 60 in.)

At least 4 years old

For more information or to have your restraint system inspected by a certified professional, visit the CPSAC website
<https://cpsac.org/find-a-tech/>

WARNING!

DEATH OR SERIOUS INJURY can occur if you fail to follow the warnings, instructions, and labels on the child restraint.

- Read **ALL INSTRUCTIONS** before use of the child restraint.
- Read the vehicle owner's manual for information on child restraint installation.
- **KEEP INSTRUCTIONS FOR FUTURE USE.**
- **DO NOT** allow anyone who has not read the instruction manual to install or use this child restraint.
- Your child's safety is your responsibility.
- **DO NOT** use the child restraint if it is damaged or broken or if parts are missing.
- Use only with a child that is at least 4 years old, weighs between 18 - 54 kg (40 - 120 lb.), and whose height is between 110 - 152 cm (43 - 60 in.).
- According to accident statistics, children are safer when properly restrained in the rear seating positions than in the front seating positions.
- If your vehicle does not have a back seat, review your vehicle owner's manual.

WARNING!

DEATH OR SERIOUS INJURY can occur if you fail to follow the warnings, instructions, and labels on the child restraint.

- This restraint is certified for use only in passenger vehicles. This restraint is not certified for aircraft use, as aircraft belts will not accommodate proper installation of this restraint.
- Failure to follow these instructions and the child restraint's labels can result in the child striking the vehicle's interior during a sudden stop or crash.
- If an air bag inflates, it can hit the child and the child restraint with great force and cause serious injury or death to your child. Review your vehicle owner's manual for more information about air bags and child restraint use.



WARNING!

DEATH OR SERIOUS INJURY can occur if you fail to follow the warnings, instructions, and labels on the child restraint.

- **DO NOT** remove lower anchor system from the child restraint.
- When forward-facing, children should use a belt-positioning highback booster seat as long as possible until they reach the maximum weight or height. At that point, children should ride in a belt-positioning backless booster seat. A booster is no longer needed once the vehicle seat belt fits properly, typically when they reach 152 cm (60 in) tall. Be sure to consult local, provincial and territorial laws applicable to the use of a child restraint system, as well as the recommendations of the Canadian Paediatric Society and Transport Canada.
- **NEVER** leave child unattended.
- **NEVER** modify any part of the child restraint.

WARNING!

DEATH OR SERIOUS INJURY can occur if you fail to follow the warnings, instructions, and labels on the child restraint.

- **DO NOT** use the child restraint if it is damaged in any way. To find out if damaged parts are replaceable, call 1-866-798-7866.
- **NEVER** attach two lower anchor connectors to one vehicle lower anchor point unless specifically allowed by the vehicle manufacturer.
- **DO NOT** attach additional padding, toys, or other devices unless made by Joie and described in these instructions. Use only approved accessories. Unapproved items can injure your child and may void the warranty.
- **NEVER** leave child restraint unsecured in your vehicle, even when it is unoccupied. In a crash, it could become a projectile and injure other vehicle occupants.

WARNING!

DEATH OR SERIOUS INJURY can occur if you fail to follow the warnings, instructions, and labels on the child restraint.

- **NEVER** use clothing or blankets that interfere with providing a properly tightened seat belt. An unsecured or improperly harnessed child can come out of the restraint during a crash.

This restraint system conforms to the Canada Motor Vehicle Safety Standard.

WARNING!

NEVER use a child restraint that has been involved in a **MODERATE** or **SEVERE** crash.

Even if there is no visible damage, the child restraint's internal structure may be compromised and may not protect your child in a future crash.

The child restraint is still usable after a minor incident which includes all of the following situations:

- 1) The vehicle was able to be driven away from the crash site.
- 2) The vehicle door nearest the child restraint was **NOT** damaged.
- 3) None of the passengers in the vehicle sustained any injuries in the crash.
- 4) If the vehicle has air bags, the air bags did not deploy during the crash; and
- 5) There is no visible damage to the child restraint.

Contact Joie Consumer Service with any questions or concerns.

Best Practices:

Expiration:

DO NOT USE THIS CHILD RESTRAINT 10 YEARS AFTER ORIGINAL PURCHASE.

Stop using it after that date and dispose of it. If the original purchase date is unknown, the manufacture date located on the child restraint should be used.

Hot Weather Warning:

Child restraints can become extremely hot in the sun or warm weather. Always check the seat temperature before placing your child inside to avoid burns.

Clothing:

For proper seat belt and child safety, avoid bulky clothing like heavy jackets or snowsuits when using the child restraint. Ensure the seat belt is snug and comfortable on your child.

Vehicle Compatibility:

You **MUST** read and understand **ALL** child restraint-related instructions and warnings in your vehicle owner's manual to correctly and safely use this child restraint in your vehicle.

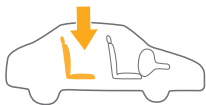

This child restraint can **ONLY** be installed on vehicle seats that face forward. **DO NOT** install on seats that face to the sides or rear of the vehicle.



NEVER attach two lower anchor attachments to one vehicle lower anchor point unless specifically allowed by the vehicle manufacturer.

If your vehicle is equipped with front passenger side air bags, check your vehicle owner's manual for child restraint installation instructions.

Vehicle Belts:

These vehicle belts CANNOT BE USED with your child restraint.

1 - Motorized Belts (Automatic)

These should not be used unless the shoulder belt can be removed, the lap belt is locked, and use is allowed by the vehicle manufacturer.

2 - Airbag/Inflatable Belts

3 - Door Mounted Belts

4 - Lap Belt ONLY

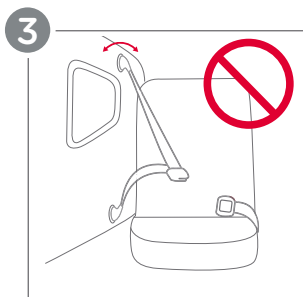
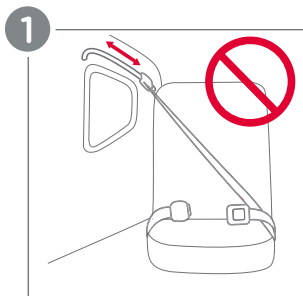

UAS Overview:

UAS (Universal Anchorages Systems):

The UAS system, or lower anchor attachment and top tether, allows you to securely attach your child restraint in your car without using the vehicle seat belt. All 2003 and newer model year vehicles are required to have a UAS system, although some manufacturers began including UAS earlier. Some vehicle owner's manuals use the term ISOFIX & LATCH to identify the UAS system.

Vehicle's Tether Anchor

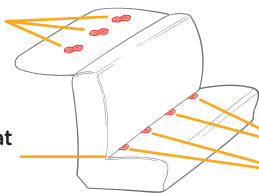

Vehicle Seat Bight

Typical seat in a passenger vehicle. Other vehicle types may have different UAS locations.

UAS Lower Anchors



Review your vehicle owner's manual for exact location and use.

Vehicle Belt Install:

Vehicle Seat Belt:

Refer to your vehicle owner's manual to determine if the belts in your vehicle lock by switching the seat belt's retractor **OR** have a locking latch plate that locks the vehicle's seat belt.

Vehicle Seat Belt Terms Retractor

A device that winds up the unused vehicle seat belt. It is often hidden inside the panels on the walls of the vehicle or in the vehicle seatback.

Latch Plate

The male end of the seat belt with the metal tongue.

Buckle

Seat Bight

The crease where the vehicle seat back and seat bottom meet.

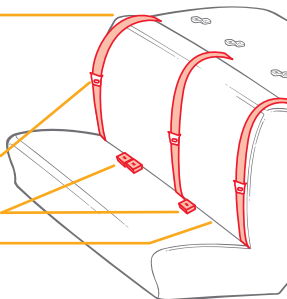

Review your vehicle owner's manual for exact location and use.

Identify Your Seat Belt Type:

The vehicle seat belt types that can be used with this child restraint.

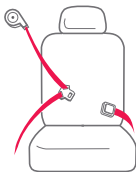

Lap/Shoulder Belt

3 connection points

Highback Booster Requirements:

Installation Method

Suitable For

Lap/Shoulder Belt

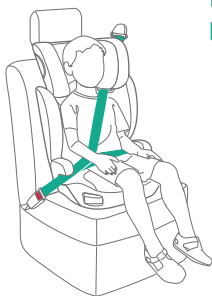

Install
pg. 26

Height 110 - 145 cm
(43 - 57 in.)

Weight 18 - 50 kg
(40 - 110 lb.)

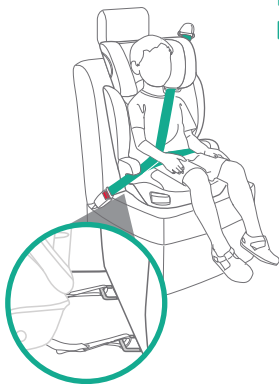

Lower Anchor Attachments
with Lap/Shoulder Belt



Install
pg. 26

At least 4 years old

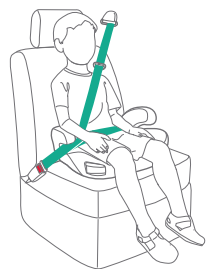
Backless Booster Requirements:

Installation Method	Suitable For
<p data-bbox="78 248 362 291">Lap/Shoulder Belt</p> <p data-bbox="404 305 528 378">Install pg. 30</p> 	<p data-bbox="549 596 911 684">Height 110 - 152 cm (43 - 60 in.)</p> <p data-bbox="549 713 890 800">Weight 23 - 54 kg (50 - 120 lb.)</p>
<p data-bbox="78 757 497 829">Lower Anchor Attachments with Lap/Shoulder Belt</p> <p data-bbox="404 844 528 917">Install pg. 30</p> 	<p data-bbox="549 844 911 888">At least 4 years old</p>

Parts List:

Please make sure there are no missing parts. Please contact Joie Consumer Service if anything is missing.

- 1 Head Support
- 2 Back Support
- 3 Armrest (x2)
- 4 Backless Booster
- 5 Lower Anchor Attachments Release Button
- 6 Cup Holder
- 7 Head Support Adjustment Lever
- 8 Shoulder Belt Guide
- 9 Lower Anchor Attachments Adjustment Strap
- 10 Lower Anchor Attachment (x2)
- 11 Instruction Manual Storage
- 12 Shoulder Belt Positioning Strap Slot
- 13 Shoulder Belt Positioning Strap (Butterfly End)
- 14 Shoulder Belt Positioning Strap (Loop End)
- 15 Shoulder Belt Positioning Clip

Parts List:

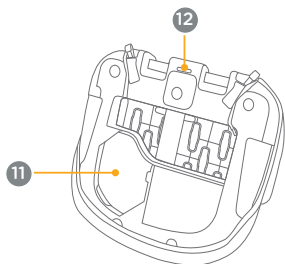
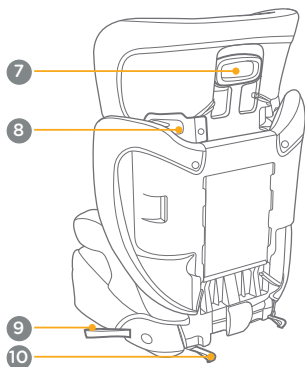
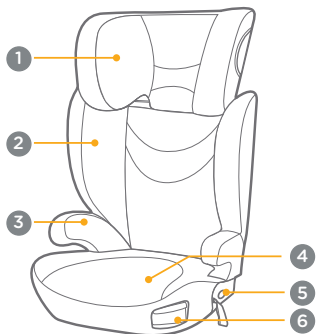

Optional Use

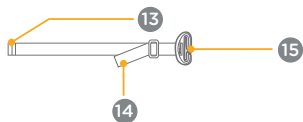

Booster Assembly:

- 1** - Place the backless booster down and line the hooks on the bottom of the back support up with the bars on the backless booster. Press the hooks down firmly onto the bars. A “clicking” sound will confirm that the back is properly attached.
- 2** - Rotate the back support up to lock it onto the backless booster.
- 3** - While squeezing the head support adjustment lever, slide the head support into the slot on the top of the back support.
- 4** - Tuck the fabric on the head support behind the fabric on the back support, as shown.

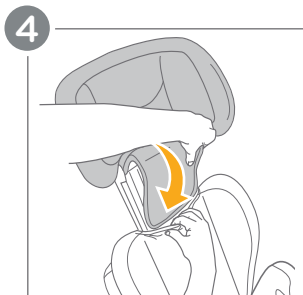
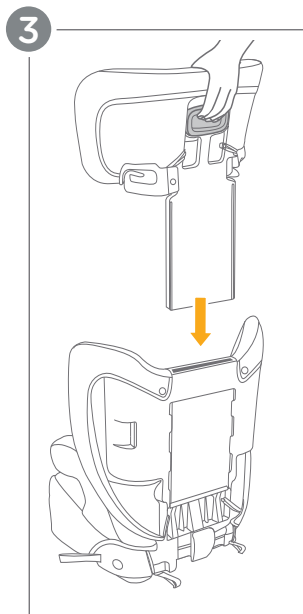
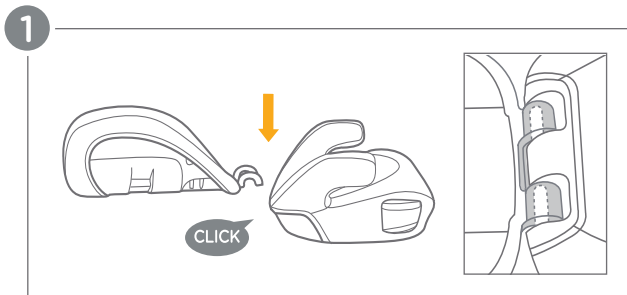

Head Support Adjustment:

The head support **MUST** be adjusted so that the bottom of the head support is **EVEN** with or **JUST ABOVE** the top of the child's shoulders.

1 - To adjust the head support, squeeze the head support adjustment lever and slide the head support up or down to the correct position.

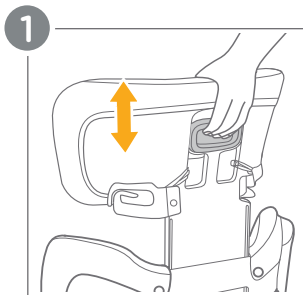

Install Highback Booster:

WARNING! Use only the vehicle's lap and shoulder belt system when restraining the child in this booster seat.

Lower anchor attachments are only available on certain models. If your booster does NOT have lower anchor attachments, please skip ahead to step 4.

- 1** - Press the lower anchor attachment release button and pull both of the lower anchor attachments out.
- 2** - Attach **BOTH** lower anchor attachments to the correct lower anchor points in your vehicle.
- 3** - Tighten the lower anchor attachments by pulling the lower anchor attachments adjustment strap. Push the child restraint down firmly while tightening to remove any slack in the straps.
- 4** - Place the child in the child restraint and buckle them in (a). Make sure **BOTH** the lap and shoulder belt are **UNDER** the armrest (b).
- 5** - Thread the shoulder belt correctly through the shoulder belt guide on the head support.

(Install Highback Booster continued on pg. 28)

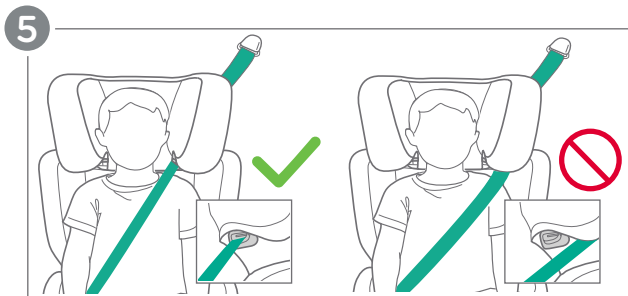
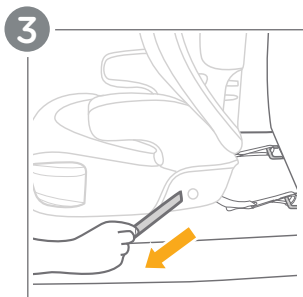
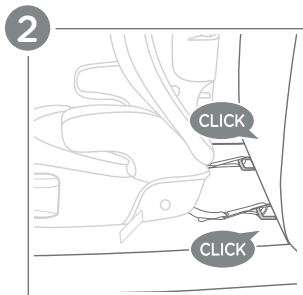
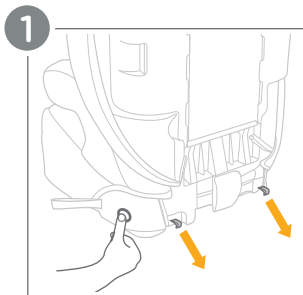

Install Highback Booster: (cont.)

6 - The bottom of the head support **MUST** be **EVEN WITH** or **JUST ABOVE** the top of your child's shoulders. **If NOT please refer to Head Support Adjustment on pg. 24.**

7 - The shoulder belt should be positioned in the blue zone when properly adjusted. Make sure the shoulder belt lays flat against your child's chest and is not twisted.

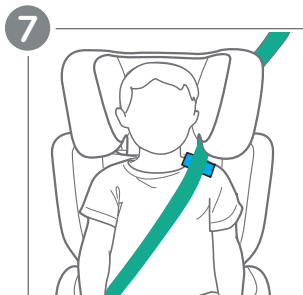
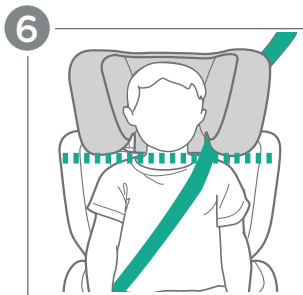

Install Backless Booster:

WARNING! Use only the vehicle's lap and shoulder belt system when restraining the child in this booster seat.

1 - Rotate the back support completely horizontal to detach it from the backless booster.

Shoulder belt positioning clip (optional):

Use the shoulder belt positioning clip if the seatbelt does not naturally fall in the blue zone on the child's shoulder on pg. 29.

2 - To install the shoulder belt positioning clip, insert the shoulder belt positioning strap (butterfly end) into the slot on the bottom of the backless booster. Pull on the strap to ensure that it is secured in place.

3 - Thread the shoulder belt positioning clip up through the correct slot for either right or left shoulder install.

(Install Backless Booster continued on pg. 32)

1

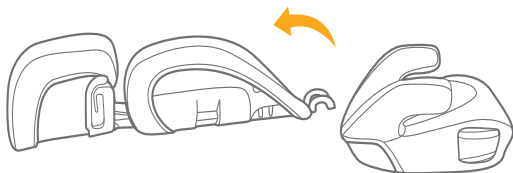

2

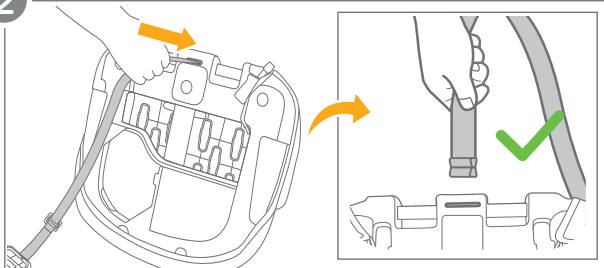

3

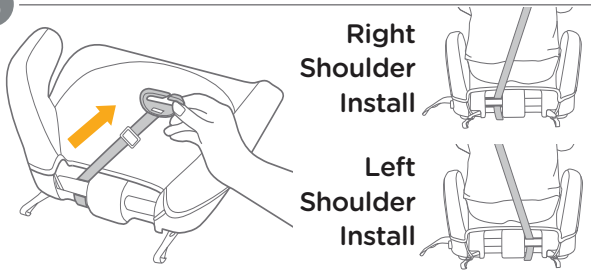

Install Backless Booster: (cont.)

Lower anchor attachments are only available on certain models. If your booster does NOT have lower anchor attachments please skip ahead to step 7.

4 - Press the lower anchor attachments release button and pull both of the lower anchor attachments out.

5 - Attach **BOTH** lower anchor attachments to the correct lower anchor points in your vehicle.

6 - Tighten the lower anchor attachments by pulling the lower anchor attachments adjustment strap. Push the child restraint down firmly while tightening to remove any slack in the straps.

7 - Place the child in the child restraint and buckle them in (a). Make sure **BOTH** the lap and shoulder belt are **UNDER** the armrest (b). Make sure the shoulder belt lays flat against your child's chest and is not twisted.

8 - Thread the shoulder belt through the shoulder belt positioning clip. Tighten or loosen the shoulder belt positioning strap so that the clip sits just above the shoulder, with the bottom of the clip just above the child's shoulders, as shown.

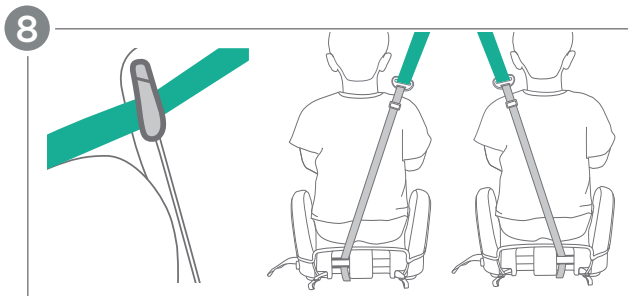
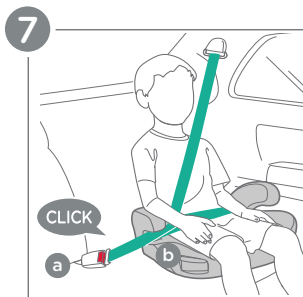
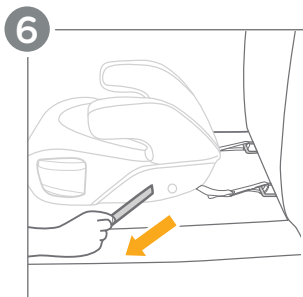
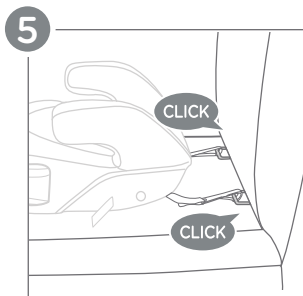
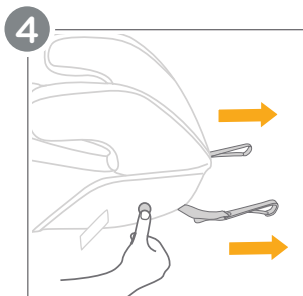

Removing/Storing Lower Anchor Attachments:

- 1** - Press the lower anchor attachments release button and pull the base away from the seat bight to loosen the lower anchor attachments strap.
- 2** - Unclip both lower anchor attachments from the lower anchor points.
- 3** - Pull the lower anchor attachments adjustment strap to pull the lower anchor attachments into the storage position.

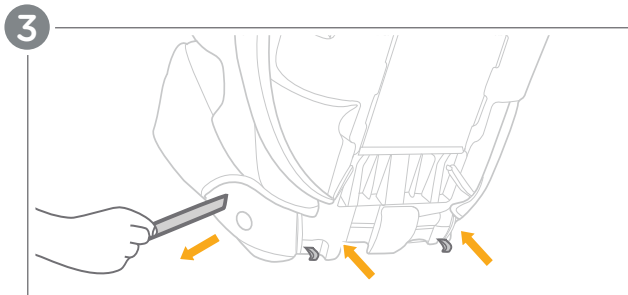
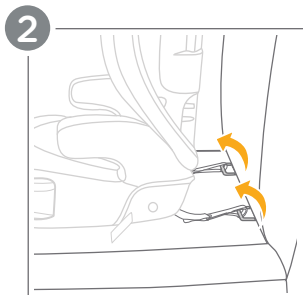
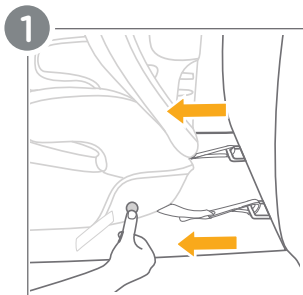

Cup Holders:

1 - Pull the cup holders out of the base on either side to use.

IMPORTANT: The maximum recommended weight in each cup holder is 0.5 kg (1 lb.).

IMPORTANT: DO NOT use the cup holders for hot beverages.

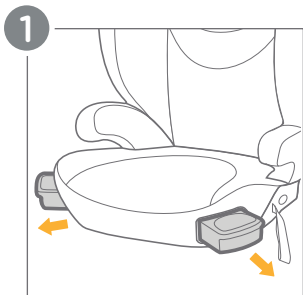

Removing Softgoods:

WARNING! NEVER use this child restraint without the softgoods in place.

- 1** - To remove the softgoods, unhook the six elastic straps on the back of the child restraint.
- 2** - Unfasten the two hooks on the back of the back support by sliding them down. Then, remove the covers from the head support, back support, and backless booster.
- 3** - Remove the foam located on the underside of the backless booster cover. **DO NOT** wash the foam.

To reassemble, follow these steps in reverse order.

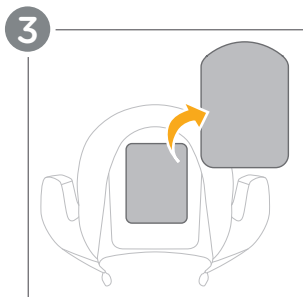
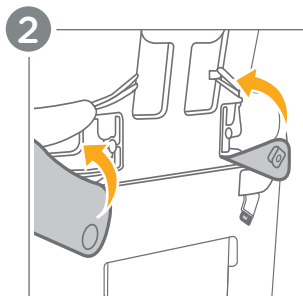
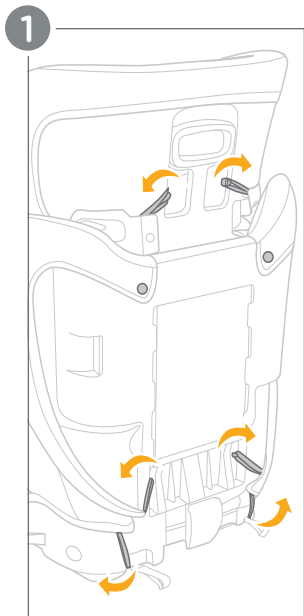

Care and Maintenance:

Washing:

Refer to the care label attached to the fabrics for washing and drying instructions. Remove the seat pad foam from inside the backless booster fabric before washing (see pg. 38).

Cleaning:

Use only mild detergent, water, and a soft cloth to clean the shell and straps. Air dry after cleaning. **DO NOT** iron the straps. **NEVER** use bleach or any other harsh chemicals anywhere on the child restraint.

Storage:

When not in use for a long period, remove the child restraint from the vehicle seat. Store the child restraint in a cool, dry place that your child does not have access to.

Care and Maintenance:

Normal Wear and Tear:

It is normal for the fabric to fade from sunlight and show wear and tear over time, even when used normally.

Regular Checks:

Regularly check that everything functions properly. If any parts are torn, broken, or missing, stop using immediately and contact Joie Consumer Service for replacement parts.

JOIE Bébé Canada Consumer Service Contact Info.

Address: PO Box 96528 RPO Brunswick,
Kirkland, Quebec H9H 5L4

Email: info.us@joiebaby.com

Phone: 1-866-798-7866

Joie™

Effortlessly happy.

Helping parents be their best
with worry-free baby gear.

IM-001959D