

Joie™

Instruction Manual

kava™

3-in-1 stroller

Weight: up to 50 lb. (22.7 kg)

Height: up to 45 in. (114.3 cm)

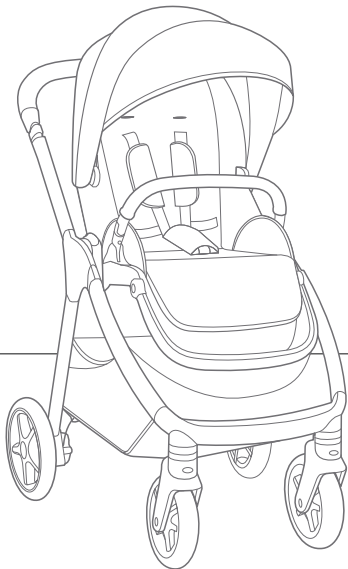

IMPORTANT!

Read all instructions before assembling and using the stroller.
Keep instructions for future use.

Contents:

- 3 Warranty Information
- 4 Warnings
- 8 Parts List
- 10 Opening Stroller
- 12 Attaching & Detaching Front Wheels
- 12 Attaching & Detaching Rear Wheels
- 14 Attaching & Detaching Canopy
- 14 Attaching & Detaching Cup Holder
- 16 Attaching & Detaching Arm Bar
- 18 Securing Your Child
- 22 Adjusting Recline
- 22 Adjusting Calf Support
- 24 Using Front Swivel Locks
- 24 Using Brake
- 26 Using Canopy
- 28 Removing Harness & Buckle Covers
- 28 Adjusting Handlebar
- 30 Using Reversible Seat
- 32 Using Seat Pad Insert
- 32 Using Side Storage Pockets
- 34 Using Removable Storage Bag
- 36 Folding Stroller
- 40 Using Accessories
- 42 Care & Maintenance

Child Usage Requirements

This stroller is suitable for use with children who meet the following requirements:

Weight: up to 50 lb. (22.7 kg)

Height: up to 45 in. (114.3 cm)

Warranty Information:

Product Registration

Please fill in the information below. The model number and the date of manufacture are located on a label on the stroller frame. Fill out the prepaid registration postcard attached to the product and mail it today. To register your product online, please visit: <https://joiebaby.com/us/register-gear>.

Model Name: _____

Model Number: _____

Date of Manufacture: _____

Date of Purchase: _____

register your
product online



Limited Warranty

We have purposely designed our high-quality products so that they can grow with both your child and your family. Because we stand by our product, our gear is covered by a custom limited warranty per product, starting from the day it was purchased. Please have the proof of purchase, model number, and date of manufacture available when you contact us. For warranty information please visit: www.joiebaby.com.

Contact

In the USA:

Joie Baby USA Consumer Service Contact Info

Address: 70 Thousand Oaks Blvd., Morgantown, PA 19543

In Canada:

Joie B  b   Canada Consumer Service Contact Info

Address: PO Box 96528 RPO Brunswick, Kirkland, Quebec H9H 5L4

Email: info.us@joiebaby.com

Phone: 1-866-798-7866

WARNING

Failure to follow these warnings and instructions could result in serious injury or death.

- **NEVER** leave your child unattended.
- **Choking Hazard:** Keep small parts away from children. These components may pose a choking hazard.
- **Suffocation Risk:** Remove all plastic covers before using the stroller. Destroy these covers or keep them completely out of the reach of children.
- **Broken Stroller:** If the stroller becomes damaged or broken, stop using it immediately. A damaged stroller can be unsafe.
- **Modification Warning: DO NOT** modify the stroller in any way unless specified in the manual. Unauthorized changes can compromise safety.
- **Genuine Parts Only:** Use only genuine parts and accessories from Joie.
- **Overloading, incorrect folding, and using accessories other than those approved by Joie,** e.g., child seats, bag hooks, rain covers, buggy boards, baskets, etc., may damage or make the stroller unstable and unsafe.

WARNING

Failure to follow these warnings and instructions could result in serious injury or death.

- **Weight & Height Limits:** This stroller is only suitable for children up to 50 lb. (22.7 kg) and 45 in. (114.3 cm) tall. Exceeding these limits can cause wear and tear, potentially leading to an unstable stroller.
- **Single Child Use:** This stroller is designed for one child only. **NEVER** transport more than one child at a time.
- **To prevent a hazardous, unstable condition, DO NOT** place more than 10 lb. (4.5 kg) in the storage basket, more than 2 lb. (1 kg) in the removable storage bag, or more than 1 lb. (0.5 kg) in each side storage pocket. **NEVER** place purses, shopping bags, parcels, or other items on the handlebar or canopy.
- **DO NOT** use the storage basket as a child carrier.
- **DO NOT** let your child play with the stroller.
- **Avoid serious injury from falling or sliding out. ALWAYS** use the harness. After fastening the buckles, adjust the straps to get a snug fit around your child.

WARNING

Failure to follow these warnings and instructions could result in serious injury or death.

- **Avoid Finger Entrapment:** Use care when folding and unfolding the stroller. Ensure that the stroller is fully erected and locked before allowing your child near the stroller.
- **Strangulation Hazard: DO NOT** place items with a string around your child's neck, suspend strings from the stroller, or attach strings to toys.
- **Strangulation Hazard:** Keep the removable storage bag with the carrying strap and the infant car seat adapters out of the reach of children at all times.
- **ALWAYS** keep your child in view while they are in the stroller.
- **NEVER** allow your child to stand on the stroller.
- **The brake MUST be engaged** when the stroller is stopped and when placing and removing your child.
- **Negotiate curbs and rough ground carefully.** Repeated impact could cause damage to the stroller.
- **The stroller is to be used only at a walking speed** and is not intended for use while jogging, skating, etc.

WARNING

Failure to follow these warnings and instructions could result in serious injury or death.

- **NEVER** use the stroller on stairs or escalators. You may suddenly lose control of the stroller, or your child may fall out.
- **The stroller does not replace a crib or a bed.** Should your child need to sleep, they should be placed in a crib or sleeping area based on their requirements.
- **ALWAYS** allow the fabric to air dry away from direct heat.
- **DO NOT** leave the stroller near a strong heat source, i.e. a radiator or open fire.
- **DO NOT** store the stroller in a damp place.
- **To avoid burns, NEVER** put hot liquids in the cup holder.
- **To prevent a hazardous, unstable condition, DO NOT** place more than 1 lb. (0.5 kg) in the cup holder.
- **When using the stroller frame with a Joie infant car seat,** refer to the child usage requirements listed in the car seat instruction manual.

Parts List:

Please make sure there are no missing parts. Please contact Joie Consumer Service if anything is missing.

- 1 Stroller Frame
- 2 Front Wheels
- 3 Rear Wheels
- 4 Infant Car Seat Adapter
- 5 Adapter Folding Strap
- 6 Cup Holder
- 7 Seat Pad Insert
- 8 Removable Storage Bag
- 9 Removable Storage Bag Carrying Strap
- 10 Canopy
- 11 Arm Bar
- 12 Calf Support
- 13 Footrest
- 14 Shoulder Harness
- 15 Calf Support Adjustment Button (x2)
- 16 Storage Basket
- 17 Side Storage Pocket (x2)
- 18 Front Swivel Locks
- 19 Handlebar
- 20 Seat Folding Button
- 21 Removable Storage Bag Attachment Buckles
- 22 Canopy Window
- 23 Recline Lever
- 24 Handlebar Sliding Locks
- 25 Stroller Folding Strap
- 26 Storage Latch
- 27 Brake Lever

Parts List:

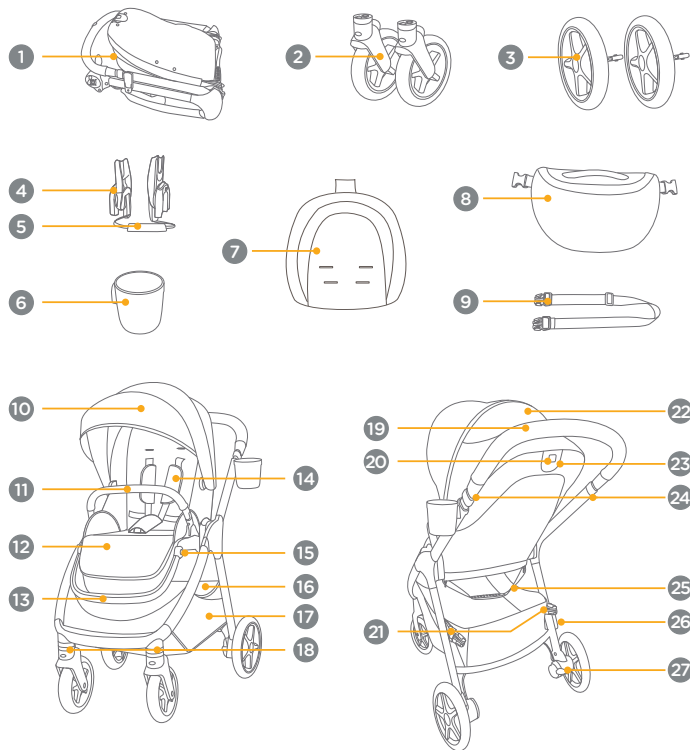

Opening Stroller:

- 1 - Separate the storage latch from the storage mount (A) by pulling out on the storage latch. **Optional:** rotate the storage latch clockwise (B) so that it is in line with the frame and out of the way.
- 2 - Lift the handlebar upwards.
- 3 - Pull back on the seat and rotate until the seat clicks into place.

IMPORTANT: Check that the stroller is completely open by pushing down on the handlebar.

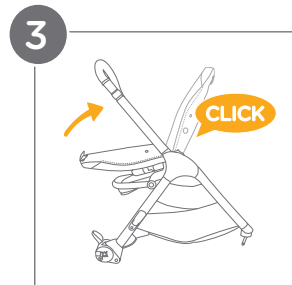
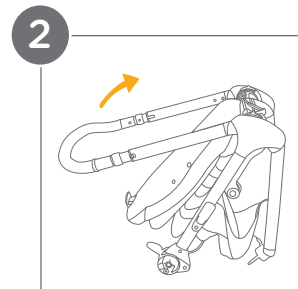
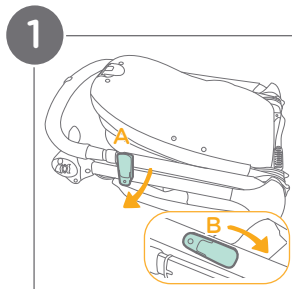

Attaching & Detaching Front Wheels:

1 - Attaching the Front Wheels:

Insert the front wheels into the front legs.

A “clicking” sound will confirm that the wheels are properly locked in place.

IMPORTANT: Safety Check: ALWAYS pull on the wheels after attachment to ensure that they are securely fastened.

2 - Detaching the Front Wheels:

Press the release button (A) on each wheel and pull the front wheel away from the front leg (B).

Attaching & Detaching Rear Wheels:

3 - Attaching the Rear Wheels:

Insert the rear wheels into the rear legs.

A “clicking” sound will confirm that the wheels are properly locked in place.

IMPORTANT: Safety Check: ALWAYS pull on the wheels after attachment to ensure that they are securely fastened.

4 - Detaching the Rear Wheels:

Press the release button (C) on each wheel and pull the rear wheel away from the rear leg (D).

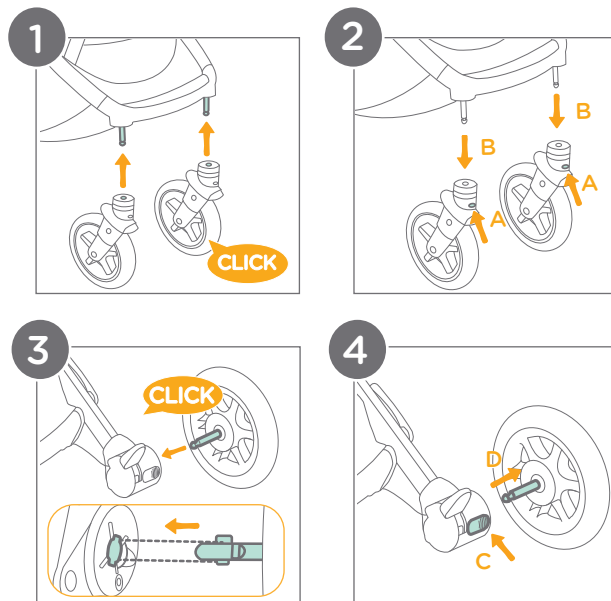

Attaching & Detaching Canopy:

Attaching the Canopy:

- 1 - Insert the canopy mounts into the slots on the stroller frame. A “clicking” sound will indicate that the canopy is properly locked in place.
- 2 - Attach the snaps on the top of the rear flap of the canopy to the corresponding snaps on the seat back.
- 3 - Align the top fabric opening around the recline lever (A). Attach the snaps on both sides of the rear flap of the canopy to the corresponding snaps on the seat back (B).

4 - Detaching the Canopy:

Repeat steps 2 and 3 in reverse order. Then, unzip both zippers on the sides of the seat back (C). Reach inside the unzipped fabric area and press both canopy release buttons (D) on the sides of the canopy mount tabs.

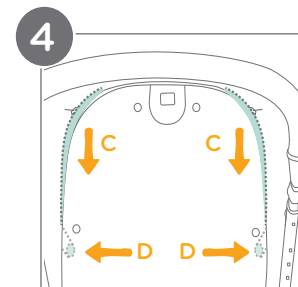
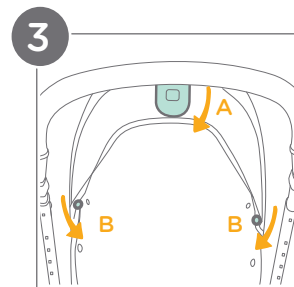
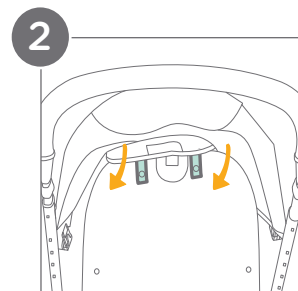
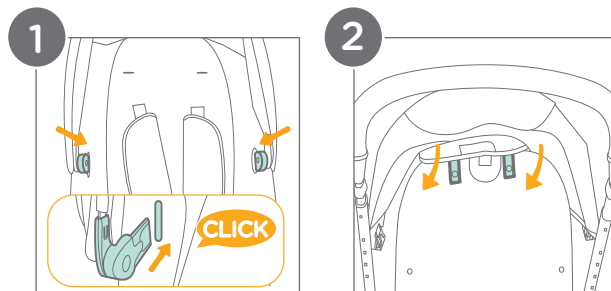

Attaching & Detaching Cup Holder:

5 - Attaching the Cup Holder:

Align the cup holder with the designated mount on the stroller frame. Slide the clip on the cup holder downward until it snaps over the mount. A “clicking” sound will indicate that the cup holder is properly locked in place.

6 - Detaching the Cup Holder:

Pull the cup holder upward to slide it off of the mount.

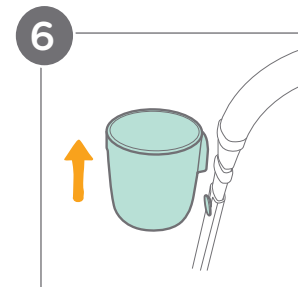
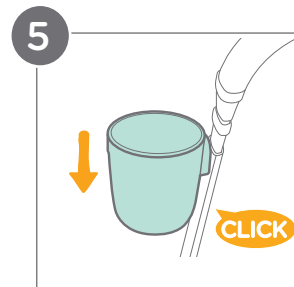

Attaching & Detaching Arm Bar:

1 - Attaching the Arm Bar:

Insert both ends of the arm bar into the arm bar mounts. A “clicking” sound will confirm that the arm bar is properly locked in place.

2 - Detaching the Arm Bar:

To remove the arm bar, press the arm bar release buttons on both sides (A) and pull the arm bar out (B).

3 - Rotating the Arm Bar:

Press and hold one arm bar release button (C) while lifting up to remove one side of the arm bar. Rotate the arm bar at the arm bar mount on the other side of the stroller (D).

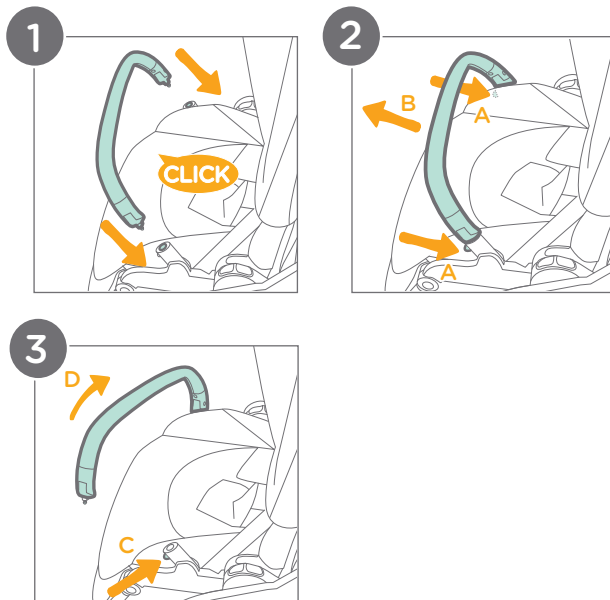

IMPORTANT: ALWAYS secure the child with the harness.

The arm bar is **NOT** a restraint device.

DO NOT lift the stroller by the arm bar. This can cause damage or injury.

Use care when attaching the arm bar onto the stroller with a child in the stroller.

CAREGIVER MUST ALWAYS help the child get into and out of the stroller.

Securing Your Child:

1 - Releasing the Restraint Buckle:

Locate the button in the center of the restraint buckle and press it firmly to release the harness straps.

2 - Locking the Restraint Buckle:

Slide the shoulder harness buckle into the waist belt buckle (A). Insert the combined buckles into the center buckle (B). A “clicking” sound will confirm that the restraint buckle is properly locked in place (C).

IMPORTANT: ALWAYS engage the brake: This is crucial whenever the stroller is stopped, especially when seating or unseating your child. A parked stroller with a disengaged brake can roll away, posing a serious fall hazard.

Secure your child with the harness: NEVER leave your child unbuckled in the stroller. A secure harness is essential to prevent your child from falling or sliding out of the stroller.

Proper harness adjustment: Ensure that the harness straps are snug but comfortable. The space between the child and the harness straps should be about a 1/2 inch (1 cm).

Shoulder strap positioning: NEVER cross the shoulder straps. **ALWAYS** keep them straight over your child's shoulders to avoid putting pressure on the child's neck.

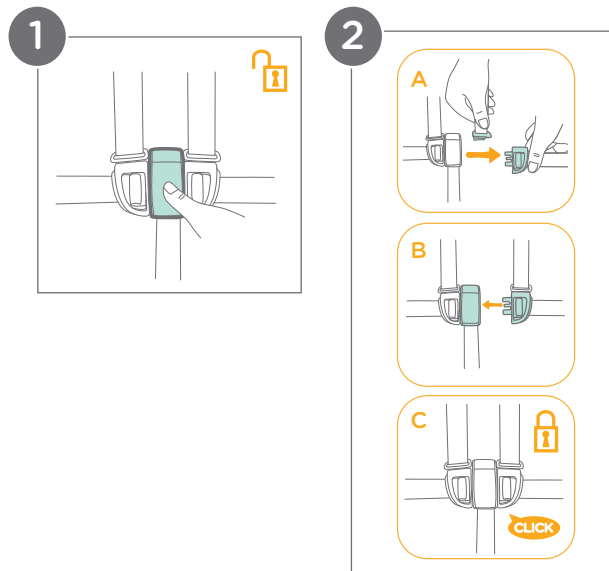

Shoulder Harness Height Adjustment:

- 1 - Detach the snaps on both sides of the rear flap of the canopy.
- 2 - Detach the snaps on the top of the rear flap of the canopy.
- 3 - Unzip both zippers on the sides of the seat back.
- 4 - Turn the harness anchor to be in line with the harness strap. Thread it through the shoulder harness slot from back to front.
- 5 - Re-thread the harness anchor through the correct slot from front to back. Ensure that both sides are adjusted to slots at the same height.
- 6 - Use the slide adjuster (A) to adjust the length of the shoulder harness straps. Pull the waist harness strap (B) to tighten the waist harness. Press the button (C) on the waist belt buckle and pull to loosen the waist harness strap (B).

IMPORTANT: DO NOT adjust the shoulder harness height with a child in the stroller.

Shoulder harness height should be at or slightly above the child's shoulders.

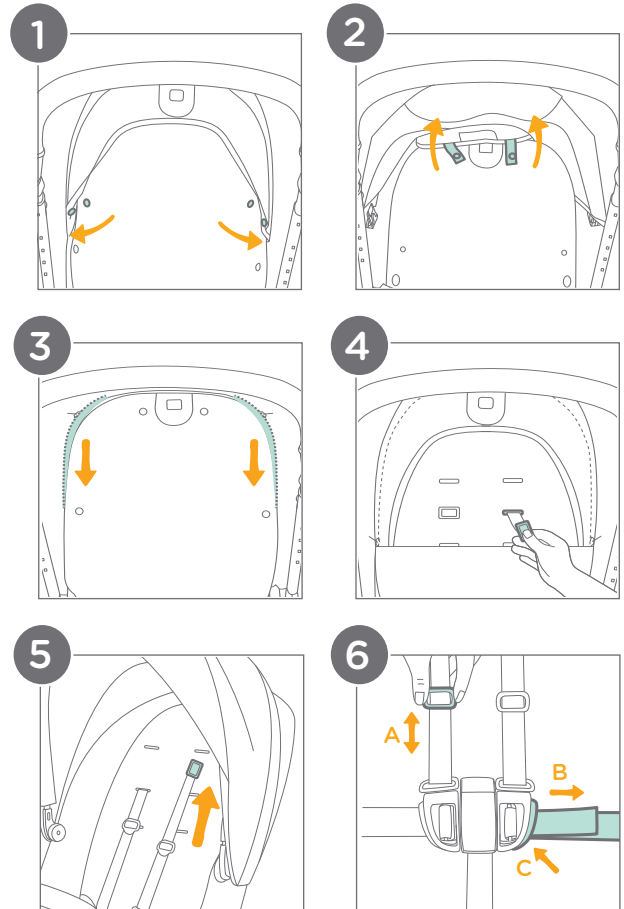

Adjusting Recline:

There are 3 recline angles for the backrest.

- 1 - Pull the recline lever (A) on the back of the seat. Pull down to recline the backrest or push up to raise the backrest (B).

DO NOT press the seat folding button (C) in the middle of the recline lever when adjusting the angle for recline.

IMPORTANT: When making adjustments to the recline, make sure the child's head, arms, and legs are clear of moving seat parts and the stroller frame to prevent injury.

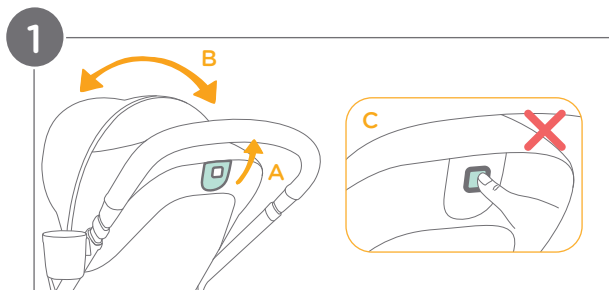

Adjusting Calf Support:

There are 2 positions for the calf support.

- 2 - To raise the calf support, lift the calf support upwards. A "clicking" sound will indicate that it is properly locked in place.
- 3 - To lower the calf support, Press the calf support adjustment buttons on both sides of the calf support (D) and rotate the calf support downwards (E).

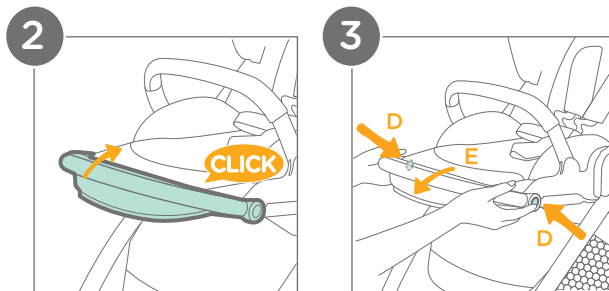

Using Front Swivel Locks:

1 - Locking the Wheels:

Ensure that the front wheels are positioned straight ahead, not angled to the side or turned around.

The swivel locks are located on the backside of each wheel.

Rotate each swivel lock clockwise to lock the front wheels in a straight position.

Unlocking the Wheels:

Rotate each swivel lock counter-clockwise. The wheels will swivel freely again.



It is recommended to use the swivel locks on uneven surfaces.

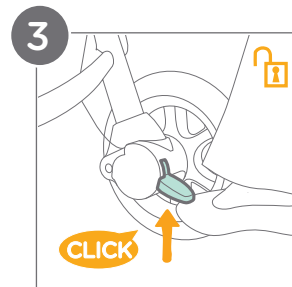
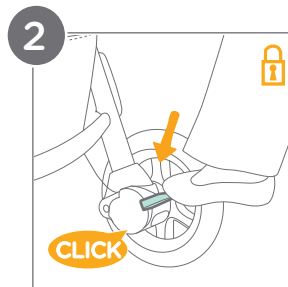
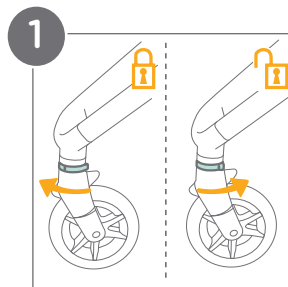

Using Brake:

2 - To lock the rear wheels, press the brake lever downwards.

3 - To unlock the rear wheels, lift the brake lever upwards.

A “clicking” sound will confirm that the brake lever is properly locked or unlocked.

IMPORTANT: ALWAYS engage the brake when the stroller is not moving.

Using Canopy:

Opening and Closing the Canopy:

- 1 - To open, pull the canopy forward toward the front of the seat. To close, push the canopy back.
- 2 - For extended canopy coverage, unzip the canopy zipper and pull the canopy fully forward.

Ventilation:

- 3 - For additional airflow, flip the canopy window cover up.

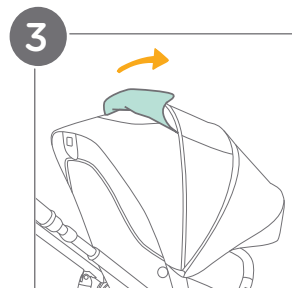
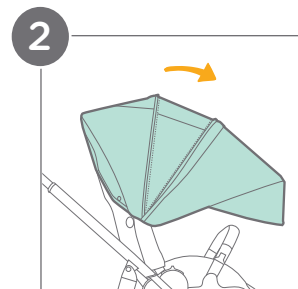
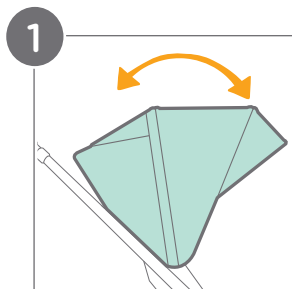

Removing Harness & Buckle Covers:

1 - Removing the Shoulder Harness Covers:

Unsnap the shoulder harness covers. Release the restraint buckle and slide the shoulder harness buckles out of the waist belt buckles. Unthread the shoulder harness straps from the elastic on the inside of the shoulder harness covers (A). Slide the harness covers off of the straps by pulling them down (B).

2 - Removing the Crotch Buckle Cover:

Release the restraint buckle. Unthread the center buckle from the elastic (C) on the inside of the crotch buckle cover. Slide the crotch buckle cover up to remove it (D).

To attach the covers, repeat the above steps in reverse order.

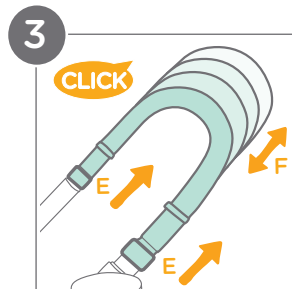
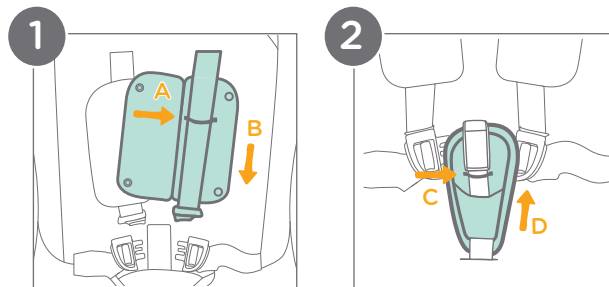

Adjusting Handlebar:

There are 4 handlebar positions:

- 3 - Pull the handlebar sliding locks (E) upwards on both sides of the handlebar and pull up or push down on the handlebar to adjust the height to the desired position (F).

Release the handlebar sliding locks to lock the handlebar in place. A “clicking” sound will confirm that the handlebar is properly locked in place.

Using Reversible Seat:

The seat is reversible, so the child can face rearward or forward.

- 1 - Use your thumbs to pull both seat release buttons towards you while holding onto the underside of the seat.
- 2 - Lift the seat off.
- 3 - Turn the seat to the reverse direction and reinsert the seat onto the seat mounts.
- 4 - A “clicking” sound will confirm that the seat is properly locked in place.

IMPORTANT: Safety Check: ALWAYS pull up on the seat to ensure that it is securely attached.

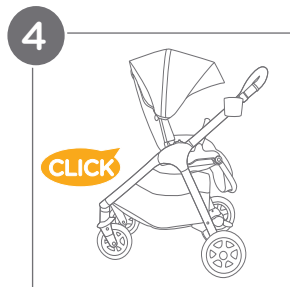
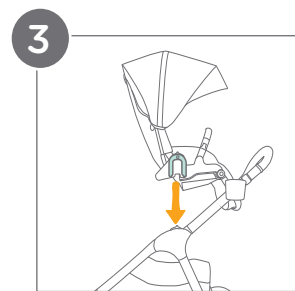
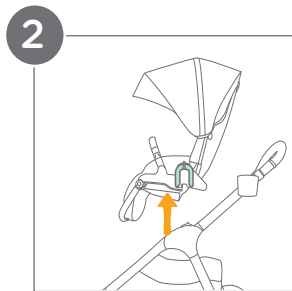
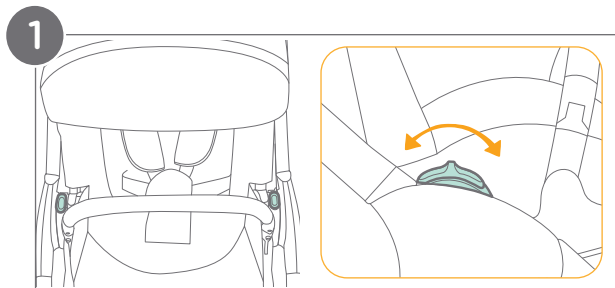

Using Seat Pad Insert:

- 1 - Release the restraint buckle.
- 2 - To remove the seat pad insert, unthread the shoulder harness straps through their respective slots (A). Detach the hook and loop fasteners on the top of the seat pad insert from the top of the backrest (B).

To attach the seat pad insert, repeat the above steps in reverse order.

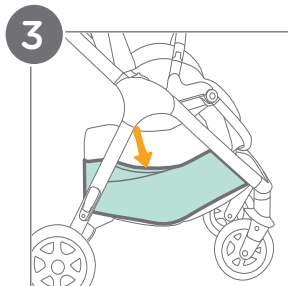
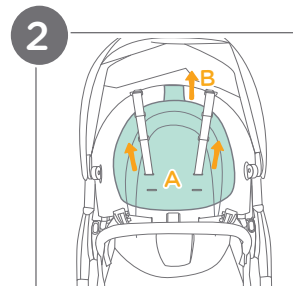
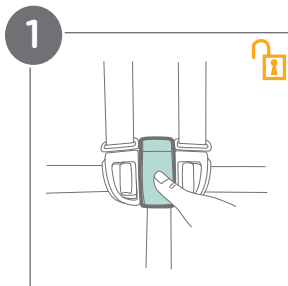

Using Side Storage Pockets:

- 3 - The side storage pockets are located on both outer sides of the storage basket. The maximum load of each side storage pocket is 1 lb. (0.5 kg).

Using Removable Storage Bag:

Attaching the Removable Storage Bag:

- 1 - Attach the hook and loop fasteners on the top of the removable storage bag to the inside of the back panel of the storage basket.
- 2 - Secure the buckles on both sides of the removable storage bag to the attachment buckles on both sides of the rear panel of the storage basket.
- 3 - A “clicking” sound will confirm that the removable storage bag is properly attached.
- 4 - Unzip the zipper to use the removable storage bag.

Detaching the Removable Storage Bag:

- 5 - Release the buckles on both sides and detach the hook and loop fasteners.
- 6 - The removable storage bag can be used separately from the stroller by attaching the carrying strap.

The total maximum weight of the removable storage bag must not exceed 2 lb. (1 kg).

WARNING! Strangulation Hazard: Keep the carrying strap and the removable storage bag out of the reach of children at all times.

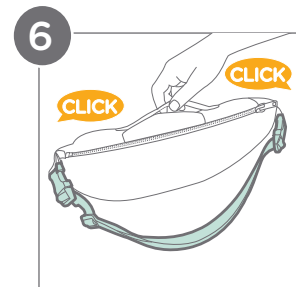
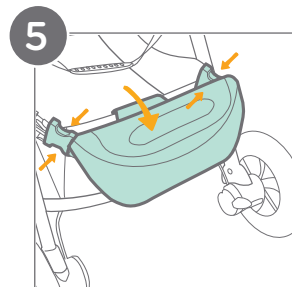
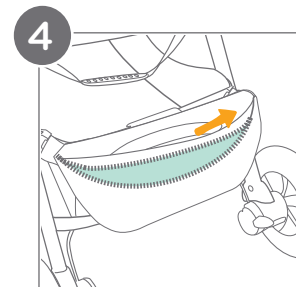
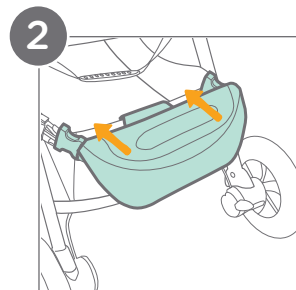
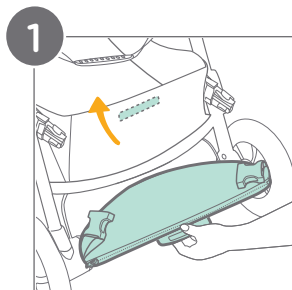

Folding Stroller:

The stroller can be folded with the seat rear-facing, forward-facing, or with the infant car seat adapters attached. **DO NOT** fold the stroller with the front swivel locks engaged.

Folding the stroller with the seat attached:

- 1 - Close the canopy (A). Ensure that the storage latch is pointing towards the back of the stroller. If it is not, rotate it counterclockwise (B).
- 2 - Press the seat folding button (C) in the middle of the recline lever and pull the recline lever (D).
- 3 - Fold the seat toward the calf support. The seat will collapse on itself and pivot down into the storage basket. The stroller can be folded when forward-facing (E) or rear-facing (F).
- 4 - Pull up firmly on the stroller folding strap.

(Folding Stroller continued on pg. 38)

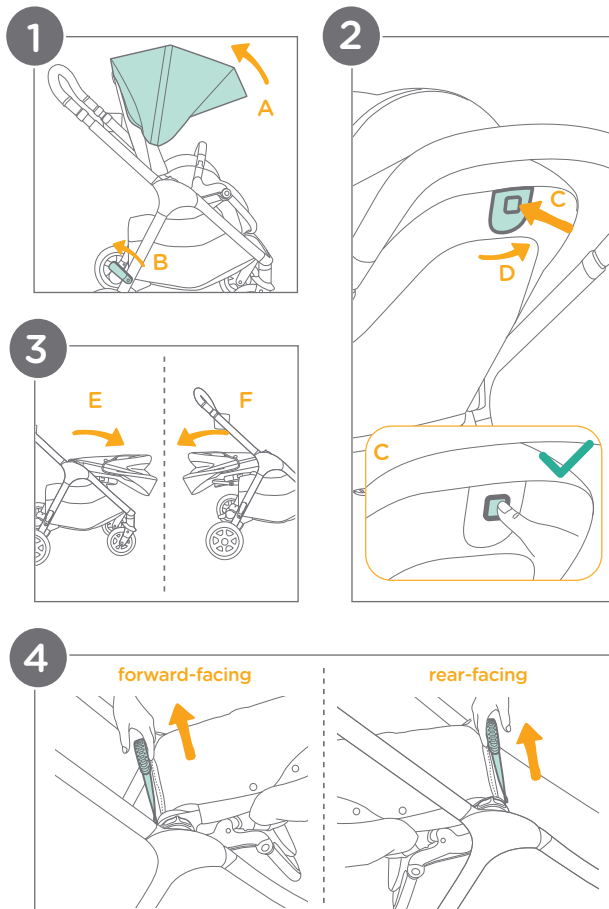

Folding Stroller: (cont.)

- 5 - The storage latch will automatically hook onto the storage mount. A “clicking” sound will confirm that the stroller is completely folded and locked.

Folding the stroller with the infant car seat adapters attached:

- 6 - Ensure that the storage latch is pointing towards the back of the stroller. If it is not, rotate it counterclockwise.
- 7 - Pull up firmly on the adapter folding strap.
- 8 - The storage latch will automatically hook onto the storage mount. A “clicking” sound will confirm that the stroller is completely folded and locked.

IMPORTANT: ALWAYS close the canopy before folding the stroller. This prevents damage to the canopy fabric.

DO NOT fold the stroller with the front swivel locks engaged.

 **The stroller can stand** when folded with the handlebar in the lowest position.

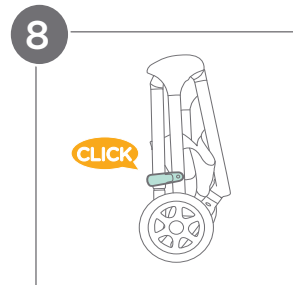
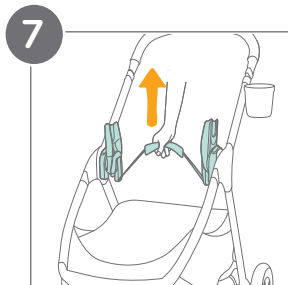
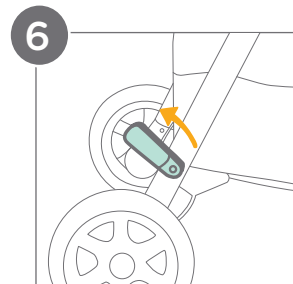
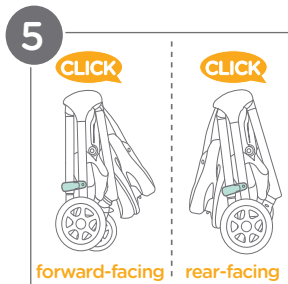

Using Accessories:

For information about using your Joie infant car seat, refer to the instruction manual included with the infant car seat.

Using with a Joie Infant Car Seat:

- 1 - First, remove the stroller seat. Use your thumbs to pull both seat release buttons (A) towards you while holding onto the underside of the seat. Lift the seat off (B).
- 2 - Attach the included infant car seat adapters to the seat mounts. A “clicking” sound will confirm that the adapters are properly locked in place.
- 3 - Attach the infant car seat by placing the car seat onto the adapters. A “clicking” sound will confirm that the car seat is properly locked in place.
- 4 - To remove the infant car seat, press the car seat release buttons (C) and lift the car seat upwards (D).
- 5 - To remove the infant car seat adapters, slide the adapter release buttons in either direction (E) and lift the adapters upwards (F).

IMPORTANT: Fall Hazard: ALWAYS check that the infant car seat is securely attached to the stroller by pulling up on the car seat.

Strangulation Hazard: Keep the car seat adapters out of the reach of children when they are not installed on the stroller.

ALWAYS secure your child with the car seat harness when using the car seat.

ONLY use Joie infant car seats with the stroller.

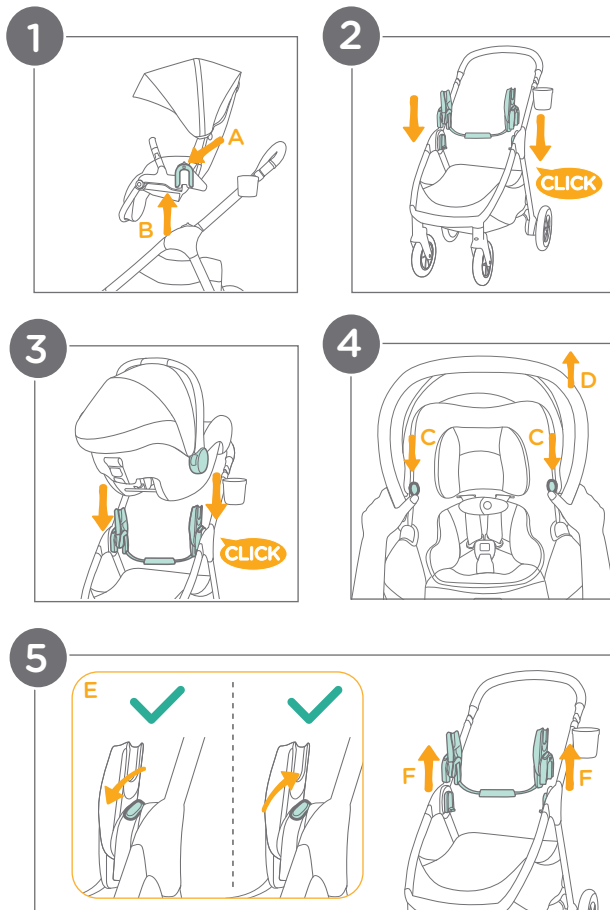

Care & Maintenance:

Cleaning:

Seat pad: Spot clean with a sponge and soapy water.

Seat pad insert and removable storage bag: Refer to care tag on the product. Air dry only.

Stroller frame: Wipe clean with a solution of warm water and mild household soap. Avoid bleach and harsh detergents.

Plastic parts: Periodically wipe clean with a damp cloth.

Metal parts: After contact with water, thoroughly dry the metal parts to prevent rust.

Maintenance:

Regular inspection: Check the stroller regularly for loose or missing parts. Discontinue use if parts are loose or missing.

Worn parts: Replace any worn or damaged parts. Use only Joie replacement parts.

Torn material or stitching: Repair or replace torn fabric or stitching. Use only Joie replacement fabrics.

Contact Joie Consumer Service at:

Email: info.us@joiebaby.com • Phone: 1-866-798-7866

Storage:

Extreme weather exposure: Avoid excessive sun or heat exposure to prevent fading or warping of parts. Avoid storing outside or in cold conditions.

Drying after use: If the stroller gets wet, open the canopy and allow it to dry completely before storing.

Wheel Maintenance:

Squeaking wheels: Apply a light coat of lubricating oil (e.g., silicone spray, anti-rust oil, or sewing machine oil) directly to the axle and wheel assembly to eliminate squeaking.

Beach Use:

After beach use: Thoroughly clean the stroller to remove sand and salt from the mechanisms and wheels. This helps to prevent rust.

Cup Holder:

Use mild detergent and warm water.

For a more thorough cleaning, remove the cup holder (see pg. 14).

The cup holder can be placed on the top rack of your dishwasher for convenient cleaning.

Joie™

Effortlessly happy.

Helping parents be their best
with worry-free baby gear.