

Joie™ signature

i-Jemini™ enhanced child restraint

使用說明書

本產品符合安全標準CNS 11497
及歐盟標準ECE R129測試和認證
組裝及使用本產品前
請先閱讀說明書全文



ECE R129/03



* 此底座需要單獨購買

13kg (約1.5歲) 以下的寶寶

恭喜您

恭喜您成為 Joie 家族的一員！很高興能與您的寶寶共度行車旅程。乘坐本產品時，您的寶寶享受的是一台高品質和通過安全標準及歐盟安全標準檢測的 O+ 級嬰兒提籃。這台嬰兒提籃適用於體重 13kg (約 1.5 歲) 以下的寶寶。請仔細研讀並依照本說明書的指示操作，如此才能保障並提供您的寶寶一個安全又舒適的行車旅程。

請確定

請確定您的汽車有三點式安全帶裝置。依照各種汽車的品牌、年份和型號，安全帶可以有不同的設計和長度。此兒童保護裝置適用符合 CNS 3972 或其他等效標準之三點式安全帶 (不含兩點式安全帶) 之車輛座椅上，因本嬰兒提籃是依標準 CNS 11497 去做測試和認證的。

底座

本說明書包含了兒童保護裝置和底座的使用方法。底座還能與某些型號的 Joie 嬰兒提籃配合使用。安裝和使用本產品前，請先閱讀說明書全文。

！重要：請仔細閱讀並妥善保存本說明書，以便日後參考。

請依圖示將說明書存放在兒童保護裝置座布下方。



目錄

參照圖示	3-12
中文	
警告	13
緊急情況處理	15
產品資訊	15
安裝模式選擇	17
產品組件及各部件名稱	18
安裝注意事項	19
調整把手	19
安裝底座	20
頭靠及肩帶高度調整	21
寶寶乘坐	21
拆卸座布	22
單獨安裝嬰兒提籃	22
配合手推車使用	23
保養維護與保固	24
汽車安裝資訊	25
English	28-44

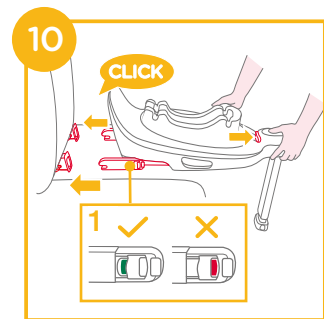
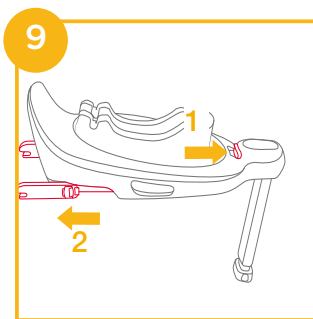
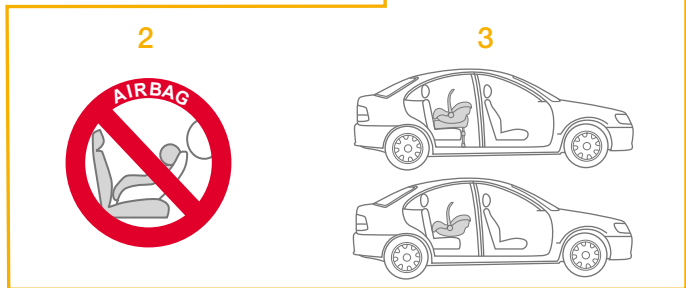
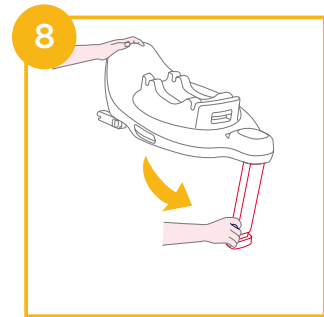
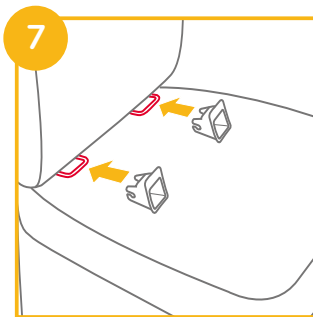
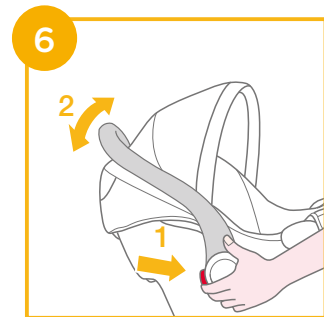
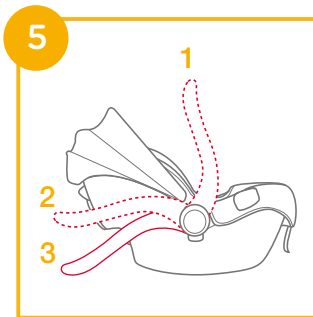
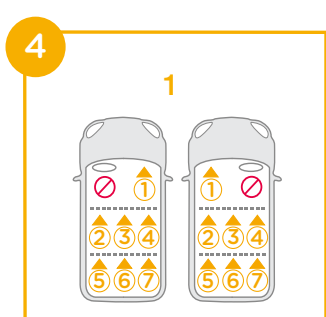
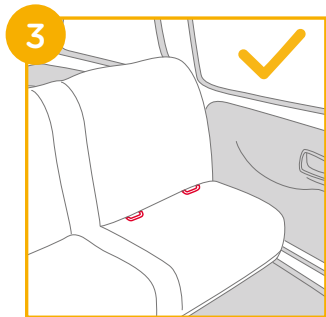
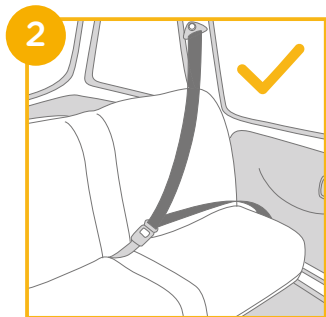
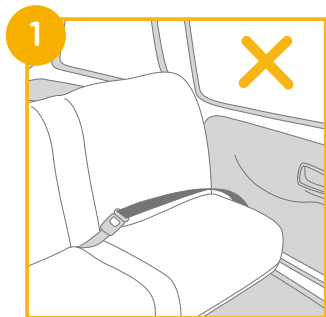

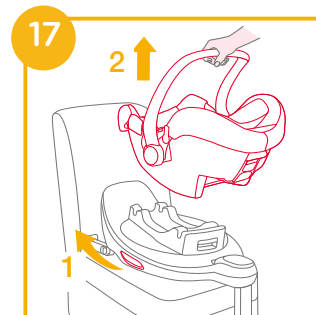
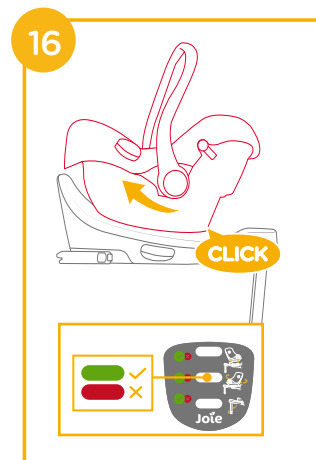
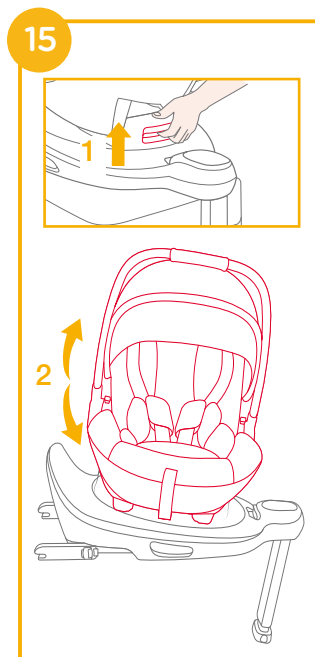
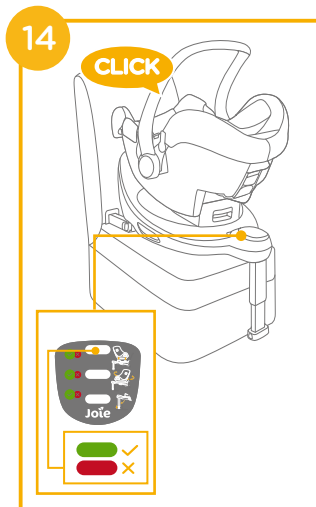
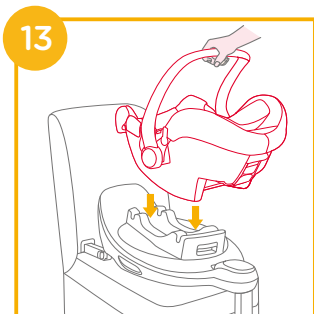
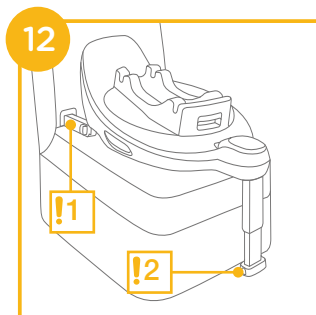
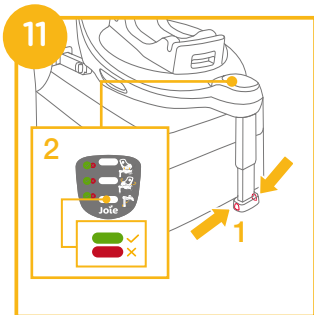

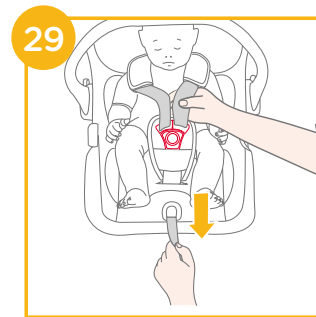
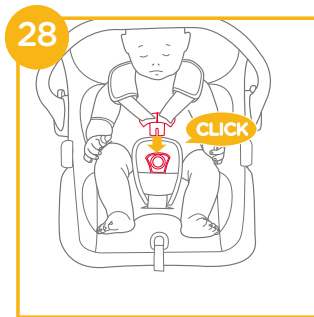
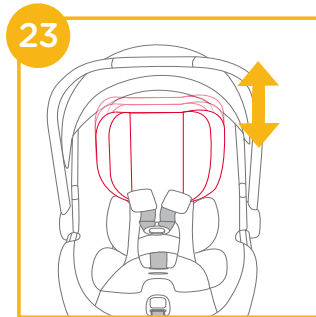
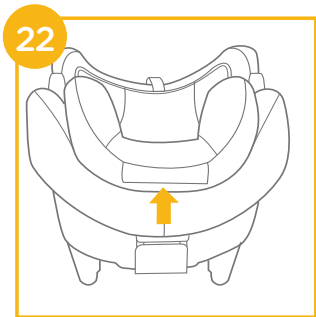
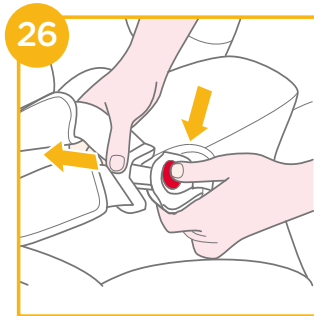
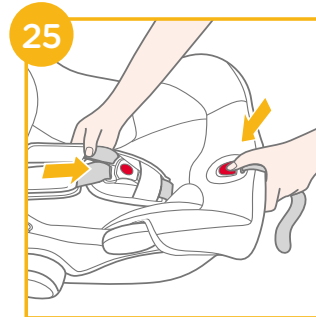
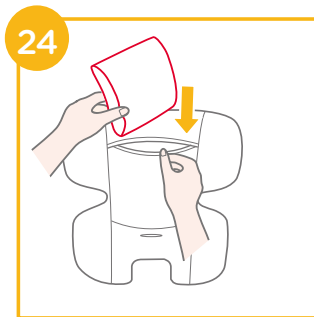
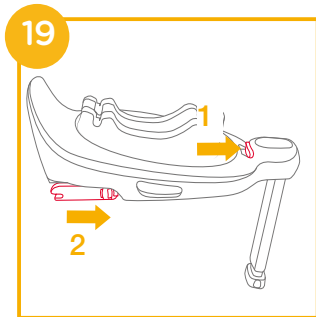
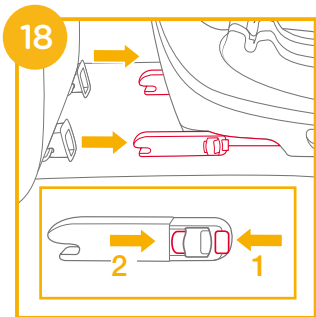

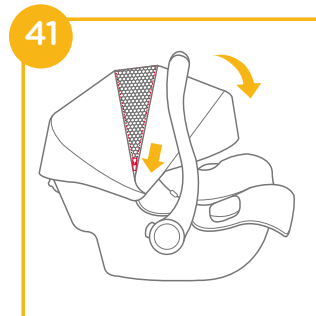
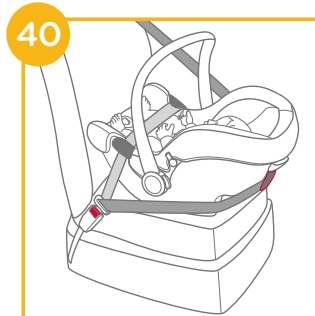
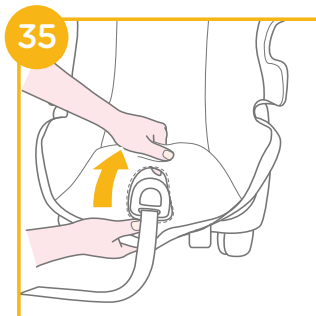
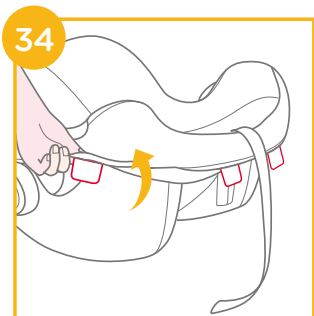
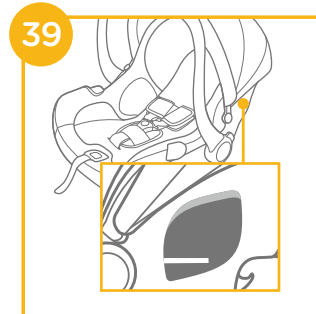
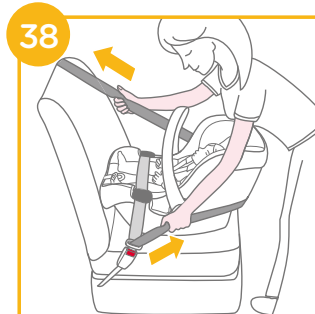
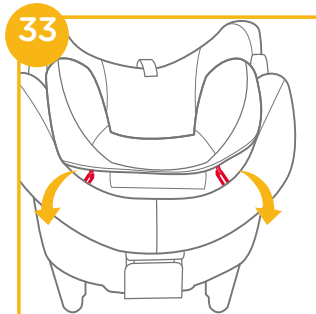
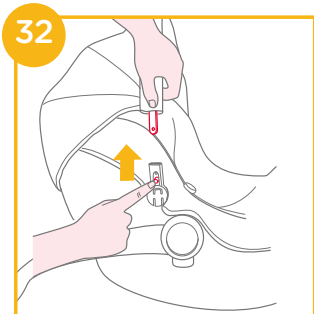
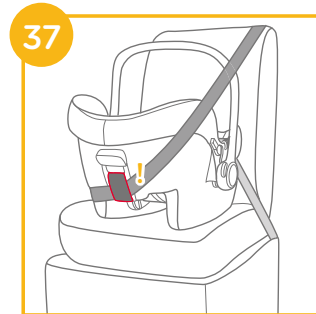
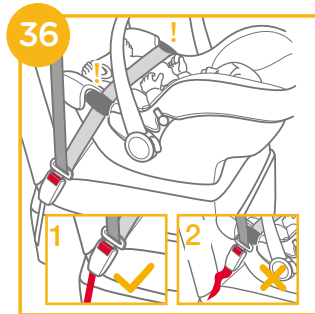
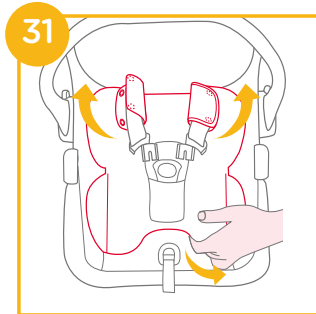
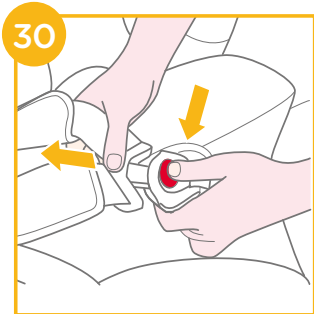

42

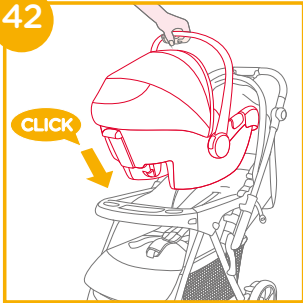

43

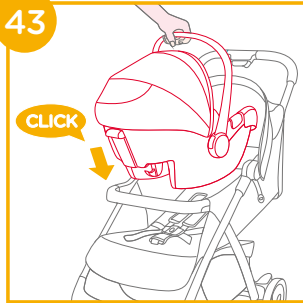

46

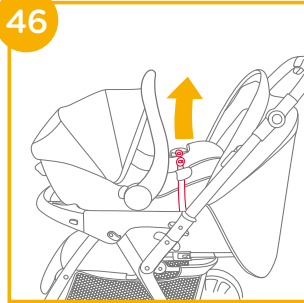

47

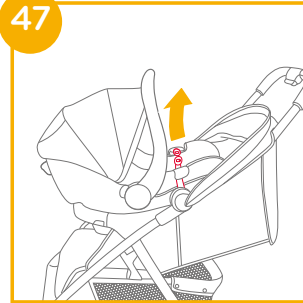

44

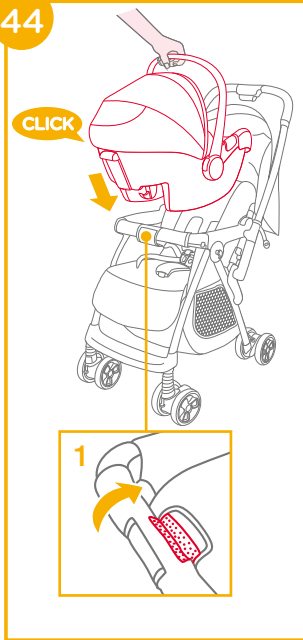

45

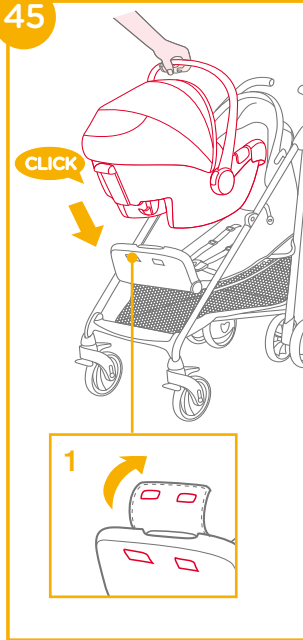

48

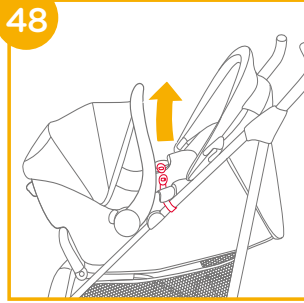

49

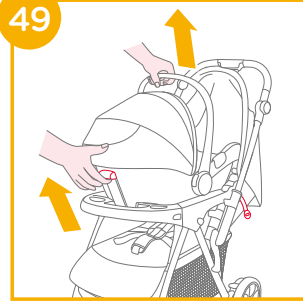

50

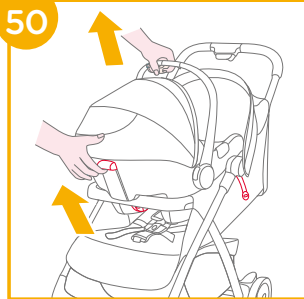

51

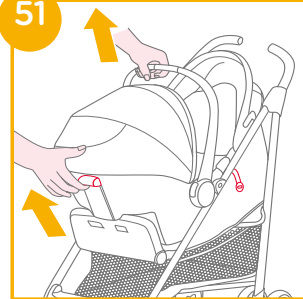

警告

- ! 沒有任何嬰兒提籃可以保證100%遠離傷亡，然而正確的使用本嬰兒提籃可以降低寶寶傷亡的機率。
- ! 本嬰兒提籃適用於體重13kg以下的寶寶。
- ! 任何束縛兒童保護裝置至車輛之織帶應束緊，任何束縛兒童之織帶應根據兒童身體進行調節，且此織帶不應扭曲。
- ! 將您的寶寶放入嬰兒提籃後，必須正確的扣合及使用嬰兒提籃安全帶。
- ! 本兒童保護裝置若於意外中遭受劇烈撞擊後，不可繼續使用，應立即更換兒童保護裝置。意外可能導致兒童保護裝置產生潛在危險。
- ! 請勿在兒童保護裝置上進行未經驗證許可之改裝或增加其他裝置以及未依兒童保護裝置製造商提供之安裝說明使用，以免造成受傷或死亡。
- ! 請讓座椅遠離日光，以免產品溫度過高對兒童的皮膚造成傷害。
- ! 在無人照料下，不得讓兒童留在兒童保護裝置內。
- ! 任何行李或其他可能在碰撞中造成傷害之物品應適當牢固。
- ! 本嬰兒提籃如有任何損壞或零件缺失時，請勿繼續使用。
- ! 請勿讓您的寶寶穿著過大的衣物，所穿的衣物必須能讓嬰兒提籃的安全帶適當而安全地扣在寶寶兩腿之間。
- ! 請勿將未固定的嬰兒提籃留在車內，以免緊急剎車時，傷害到其他乘客。若不經常使用嬰兒提籃時，請將其搬離汽車座椅。
- ! 請勿在未閱讀或了解本嬰兒提籃說明書及汽車說明書之前，使用或安裝本嬰兒提籃。
- ! 嚴禁將本兒童保護裝置置於有正面空氣囊的座位上。
- ! 請勿使用二手嬰兒提籃或來歷不明的嬰兒提籃，因為它們可能存在危害寶寶安全的潛在危險。
- ! 不可使用繩子等其他物件代替汽車安全帶，以避免兒童被粗細繩索意外勒住。
- ! 當本嬰兒提籃沒有座布時，請勿使用。
- ! 請勿使用非本製造商推薦的座布，否則會影響兒童安全座椅的總體性能。
- ! 本兒童保護裝置僅能安裝到有固定靠背的汽車座椅上，不能安裝到靠背無法固定，以致靠背向前折疊或自由轉動的汽車座椅上。
- ! 請勿使用其他廠商的小座墊或底座來配合本嬰兒提籃使用。如需更換配件時，請與代理商聯繫。
- ! 請勿放置任何物品在兒童保護裝置下方。發生撞擊時，此物品會飛出，導致織帶變鬆，並影響其他乘客的安全。
- ! 本兒童保護裝置僅能在鋪滿墊子且沒有尖銳物品的汽車座椅上使用。
- ! 必須小心定位和安裝兒童保護裝置，以免被可移動車輛座椅或車門卡住。
- ! 使用本產品前，請取掉PE袋和包裝材料，並放到嬰兒觸摸不到的地方。
- ! 長期不使用嬰兒提籃時，請將其搬離汽車座椅。
- ! 有關零件更換或維修問題，請向代理商查詢。
- ! 不管在哪種狀況下使用，把寶寶放入提籃後，請一直為寶寶繫好安全帶，以免寶寶從提籃內跌出。
- ! 手提嬰兒提籃前，請確認寶寶已繫好安全帶，且把手固定於直立段位。
- ! 請勿將嬰兒提籃置於桌子、椅子等高於地面的平台上。
- ! 不可使用除使用說明書中所標注以外之其他受力點。
- ! 請勿將任何物品置於支撐腳附近。

緊急情況處理

遇緊急事件或事故時，需迅速急救或送醫治療照顧您的寶實是非常重要的。

產品資訊

i. 配合底座安裝

1. 此為ISOFIX兒童保護裝置。符合安全標準CNS 11497。用於裝有ISOFIX固定器系統之車輛座椅。
2. 它安裝適用於車輛配有經認可之ISOFIX安裝位置。(請參照車輛使用手冊)請依此兒童保護裝置之種類及ISOFIX尺度等級，安裝於附有ISOFIX固定器之車輛座椅上。
3. 此兒童保護裝置使用之質量等級及ISOFIX尺度等級為：質量等級0+：C、D。
4. 此兒童保護裝置與底座組合構成“半通用型”兒童保護裝置，符合安全標準CNS 11497。用於裝有ISOFIX固定器系統之車輛座椅位置之安裝。
5. 其他車輛型式亦有可能適用此兒童保護裝置。若有疑問，請洽兒童保護裝置製造商或代理商。

ii. 單獨安裝嬰兒提籃

1. 此為“通用型”兒童保護裝置，符合安全標準CNS 11497。其適用大部分(並非全部)之車輛座椅。
2. 若車輛製造商在車主使用手冊中述明其可適用此質量等級之“通用型”兒童保護裝置，則本裝置可安裝於該車輛上。

3. 此兒童保護裝置歸類為“通用型”，比其他無標示此注意事項之兒童保護裝置可適用於較多車輛。
4. 若有疑問，請洽兒童保護裝置製造商或代理商。

Allison Baby UK Ltd.

Venture Point, Towers Business Park,
Rugeley, Staffordshire, WS15 1UZ
www.joiebaby.com

產品名稱	汽車用兒童保護裝置
產品型號	C1404
適用範圍	13kg (約1.5歲) 以下的寶實
主要材質	塑膠、五金、布
質量等級	0+
淨重	4.7kg
產品尺寸	438mm x 657mm x 587mm
製造日期	詳見產品上貼紙日期(年/月/日)
專利號碼	專利申請中
原產地	中國

委製商	巧兒宜國際股份有限公司
進口商	巧兒宜國際股份有限公司
地址	台北市內湖區瑞光路431號2樓
電話	02-27973000
統一編號	52603333

代理商	奇哥股份有限公司 Chickabiddy Co., Ltd
地址	台北市南京東路四段186號5樓
服務專線	0800-001-256 / 02-25781188
統一編號	04222671
網址	www.chick.com.tw

安裝模式選擇



產品組件及各部件名稱

請確認產品組件是否有遺漏，如有遺漏，請聯繫代理商。
本產品無需工具進行組裝。

- | | |
|-----------|---------------|
| 1 頭靠 | 14 把手調整按鈕 |
| 2 座墊 | 15 後向卡槽 |
| 3 推車釋鎖按鈕A | 16 推車釋鎖按鈕B |
| 4 側面卡槽 | 17 旋轉按鈕 |
| 5 小座墊 | 18 ISOFIX調整按鈕 |
| 6 調整織帶 | 19 安全指示器 |
| 7 調整按鈕 | 20 支撐腳 |
| 8 肩帶 | 21 支撐腳調整按鈕 |
| 9 遮陽篷固定座 | 22 說明書存放處 |
| 10 遮陽篷 | 23 ISOFIX連接器 |
| 11 安全扣-插扣 | 24 本體釋鎖按鈕 |
| 12 安全扣-母扣 | 25 ISOFIX導向器 |
| 13 把手 | |

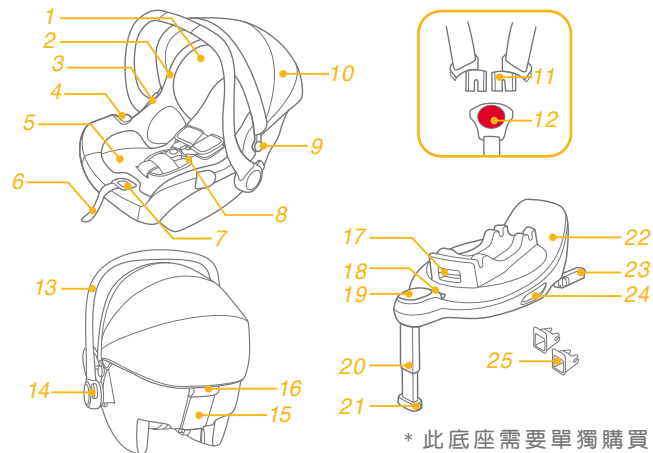

安裝注意事項

- ! 請勿將此嬰兒提籃安裝在二點式安全帶的汽車座椅上(圖1)
- ! 此產品只適合安裝在設置有三點式安全帶(圖2)或有ISOFIX固定裝置的汽車座椅上(圖3)
- ! 請勿將此產品安裝在相對於汽車的行駛方向橫向或後向(圖4.1)或有正面空氣囊(圖4.2)的汽車座椅上。
- ! 請勿將此產品安裝在前座上，防止意外發生時造成實質傷亡(圖4.3)
- ! 請勿將此產品安裝於可移動的汽車座椅上。

調整把手

把手有3個段位可供調整(圖5)

! 手提、置於汽車內或置於推車上時，請用段位1。

調整把手位置時，先按壓兩邊的把手按鈕，將把手旋轉到適合段位後再鬆開把手按鈕(圖6)

安裝底座

1. 將ISOFIX導向器固定到ISOFIX固定點上(圖7)，ISOFIX導向器既可防止汽車座椅表面被刮破，又可為ISOFIX連接器導向。
2. 展開底座支撐腳(圖8)
3. 按壓ISOFIX調整按鈕拉出ISOFIX連接器(圖9)
4. 按壓ISOFIX調整按鈕調整ISOFIX導向器，將ISOFIX連接器與ISOFIX導向器對齊後，將ISOFIX連接器插到ISOFIX固定點上(圖10)
 - ! 請確定左右兩邊的ISOFIX連接器都已牢固固定到ISOFIX固定點上。且兩個ISOFIX連接器上的指示器應顯示綠色(圖10.1)
 - ! 同時往外拉兩邊的ISOFIX連接器，以確保ISOFIX連接器已固定。
5. 將底座置於合適的汽車座椅，將支撐腳延伸到地面(圖11)。支撐腳正確安裝時，支撐腳指示器顯示綠色，否則顯示紅色(圖11.2)
 - ! 請支撐腳有多個調整段位，支撐腳指示器顯示紅色時，表示支撐腳處於錯誤段位，請重新操作至正確位置為止。
 - ! 請確保支撐腳與汽車地面完全接觸。
 - ! 按壓支撐腳調整按鈕可將支撐腳向上調整(圖11.1)
6. 底座安裝好後如(圖12)所示。
 - ! ISOFIX連接器須鎖定在ISOFIX固定點上(圖12.1)
 - ! 底座支撐腳須正確固定，並以綠色顯示(圖12.2)
 - ! 請先將兒童保護裝置安裝到汽車後座椅上，再讓寶寶乘坐。
7. 將兒童保護裝置卡入底座內(圖13)，如果兒童保護裝置固定正確，兒童保護裝置指示器將顯示綠色(圖14)
 - ! 僅在後向模式時本體才可以安裝或釋鎖。
8. 按壓旋轉按鈕可以旋轉本體，方便兒童從側面進出(圖15)
 - ! 按壓旋轉按鈕，將本體旋轉至後向模式，指示器將顯示綠色(圖16)

9. 釋鎖兒童保護裝置時，先將寶寶抱出，按壓本體釋鎖按鈕(圖17.1)，同時將本體往上提即可(圖17.2)。僅在後向模式時本體才可以安裝或釋鎖。
10. 移除底座時，按壓兩側ISOFIX連接器上的第二道安全鎖(圖18.1)與釋鎖按鈕(圖18.2)，然後將底座向外拉即可(圖18)
11. 按壓ISOFIX調整按鈕可將ISOFIX連接器儲存在底座下方(圖19)

頭靠及肩帶高度調整

請依照寶寶的身高，選擇一對高度合適的肩帶孔。

！肩帶須穿過最接近寶寶肩膀位置的肩帶孔(圖20)，肩帶位置太高是不正確的(圖21)

！若肩帶位置不合適，意外發生時可能造成寶寶被拋出嬰兒提籃的危險。

按壓頭靠調整拉桿(圖22)，同時上下滑動頭靠到合適高度，頭靠高度共有7個段位，調整如(圖23)所示。

寶寶乘坐

提示

1. 小座墊的作用是為了保護寶寶，0-6個月的寶寶必須使用小座墊。
2. 使用小座墊前，請裝上填充物(圖24)
3. 將寶寶放入提籃後，請確認肩帶高度是否合適。



如果肩部空間太小，可將側翼移除。

1. 按壓座椅前端的調整按鈕，並向外拉肩帶，以完全調鬆肩帶(圖25)
2. 按壓紅色按鈕，鬆開安全扣(圖26)
3. 將寶寶放入座椅，並扣合安全扣(圖27&圖28)
4. 向外拉調整織帶，調緊肩帶(圖29)

拆卸座布

參考(圖30-圖35)步驟即可拆卸座布。反向操作即可組裝座布。

單獨安裝嬰兒提籃

！請勿將此嬰兒提籃安裝在二點式安全帶的汽車座椅上，由於此種安全帶功能不完善，使用是非常危險的。

！此產品適合安裝在設置有三點式安全帶的汽車座椅上。

1. 將嬰兒提籃置於合適的汽車座椅上，拉出汽車安全帶後扣好汽車安全扣，再將汽車腰帶卡入嬰兒提籃兩邊的卡槽內(圖36)
！汽車安全帶母扣段若太長，汽車安全帶無法綁緊不能使用(圖36.2)
2. 將汽車肩帶卡入嬰兒提籃後面的卡槽內(圖37)
3. 用力拉緊汽車安全帶，使汽車安全帶緊實的繫住嬰兒提籃(圖38)
4. 當提籃安裝後，提籃上的水平線必須與地面水平(圖39)
！盡力拉緊汽車安全帶，並確定汽車安全帶沒有鬆弛或扭曲。
！組裝提籃後，始終檢查車輛安全帶安裝路徑正確且扣具有扣合(圖40)
5. 遮陽篷可以完全打開以保護你的小孩免受陽光直射，拉開拉鍊，然後向前拉遮陽篷(圖41)

配合手推車使用

本嬰兒提籃可搭配具有扶手、餐盤或小腿靠的Joie手推車使用。

- ! 購買前，請確定您的手推車可與本嬰兒提籃搭配使用。
- ! 本產品僅供一位寶寶使用。
- ! 安裝嬰兒提籃前請給手推車剎車。
- ! 請確定，用於固定嬰兒提籃的部件已牢固固定於手推車上。
- ! 請將手推車靠背調至最平躺段位。

請依以下步驟將嬰兒提籃安裝到手推車上：

1. 將嬰兒提籃置於手推車內，以使嬰兒提籃卡鉤卡到扶手、餐盤或小腿靠邊緣，嬰兒提籃將自動扣合到位(圖42&圖43&圖44&圖45)

- ! 扶手有布套時，請先揭開布套上的粘扣帶(圖44.1)
- ! 對於有特殊小腿靠的手推車，請先將小腿靠調至最直立位置，並揭開布套(圖45.1)

2. 用手推車兩側的固定織帶固定嬰兒提籃(圖46&圖47&圖48)

- ! 將提籃往上提，確保提籃已正確固定。

移除嬰兒提籃時，先從嬰兒提籃上取下固定織帶，按壓嬰兒提籃釋鎖把手(圖49&圖50&圖51)

保養維護與保固

- ! 小座墊支撐塊拆除後，請將其存放於寶寶無法接觸到的地方。
- ! 請以30度以下水溫清洗。
- ! 請勿使用熨斗熨燙。
- ! 請勿使用漂白劑及乾洗。
- ! 請勿使用未經稀釋的中性清潔劑、汽油或其他有機溶劑清洗本兒童保護裝置，否則可能對約束系統造成損壞。
- ! 請勿大力扭乾，過分大力扭乾可能留下皺褶。
- ! 請於陰涼處鋪平晾乾。
- ! 當長時間不使用本兒童安全座椅時，請將本兒童安全座椅從汽車座椅上拆除，並存放於陰涼處及寶寶不易接觸的地方。

延長保固服務

請於購買起一個月內至奇哥官網進行登錄，登錄成功後即享有商品延長一年保固服務。



汽車安裝資訊

NOTE

1. 此兒童保護裝置被歸類為“半通用型”，適用安裝在大部分(並非全部)之車輛座椅位置。下圖中的數字與“汽車安裝資訊”內的數字相對應。其他車輛型式亦有可能適用此兒童保護裝置，以下車型為車款安裝適配性資料。若有疑問，請洽兒童保護裝置製造商或代理商。
2. 請勿將本兒童保護裝置安裝在汽車前座上。
3. 切勿將後向兒童保護裝置裝置於有正面空氣囊的座位上，防止發生死亡或嚴重傷害。
4. 購買車輛前，請檢查其是否配置有相應的連接裝置。
5. ● 表示汽車座椅可安裝本兒童保護裝置。
6. ✘ 表示汽車座椅不可安裝本兒童保護裝置。
7.  表示符合i-Size的車輛。
8. 如果您的汽車品牌未被列入本說明書或未用“●”或“✘”進行標示，請查閱您的汽車手冊或聯絡兒童約束系統製造商，以進一步了解相關資訊。



Joie™ signature

i-Jemini™

enhanced child restraint

Instruction Manual

This child restraint is approved to CNS 11497 and UN ECE R129 series of amendments.

Please read all the instructions in this manual before installing and using the product.



ECE R129/03

With the i-Size ISOFIX connections: Child height 40cm-85cm/ Child weight ≤ 13kg

With vehicle belt: Child height 40cm-85cm/Child weight ≤ 13kg



Welcome to Joie™

You have purchased a high quality, fully certified enhanced child safety enhanced child restraint. This product is suitable for the use of child's height and weight up to 85cm and 13kg.

Carefully read this Instruction Manual and follow the installing steps because this is the ONLY way to protect your child from serious injury or death in case of an accident, and to provide comfort to your child while using this product.

Keep this instruction manual for future reference.

Please confirm

To use this Joie enhanced Infant child restraint according to the UN Regulation No.129, your child must meet the following requirements. With the i-Size ISOFIX connections: Child height 40cm-85cm/ Child weight ≤ 13kg

With vehicle belt: Child height 40cm-85cm/Child weight ≤ 13kg

Please read all the instructions in this manual before installing and using the product.

! IMPORTANT: KEEP FOR FUTURE REFERENCE. PLEASE READ CAREFULLY.

Please keep the instruction manual in the storage compartment at the inside of the seat cover.

For warranty information, please visit our website at joiebaby.com



Contents

Reference Figures

3 - 12

English

WARNING	31
Emergency	34
Product Information	34
Choose Your Installation	35
Parts List	36
Installation Concerns	37
Aeroplane Installation	37
Handle Adjustment	38
Installation with base	38
Height Adjustment	39
Securing Child	40
Detaching Canopy and Seat Pad	41
Installation without base	41
Use with Strollers	42
Care and Maintenance	43
Vehicle Fitting Information	44

WARNING

- ! Please check before you purchase this enhanced infant child restraint to make sure it can be installed properly in your vehicle.
- ! NO enhanced infant child restraint can guarantee full protection from injury in an accident. However, proper use of this enhanced infant child restraint will reduce the risk of serious injury or death to your child.
- ! To use this enhanced infant child restraint with the ISOFIX connections according to the ECE R129/03 Regulation, your child must meet the following requirements.
i-Jemini: Child height 40cm-85cm/ Child weight≤13kg (approximately 1.5 years old or under).
- ! To use this infant carrier module with vehicle belt, your child must meet the following requirements.
i-Jemini: Child height 40cm-85cm/ Child weight≤13kg (approximately 1.5 years old or under).
- ! Any straps holding the enhanced child restraint to the vehicle should be tight; any support-leg should be in contact with the vehicle floor; any straps or impact shields restraining the child should be adjusted to the child's body, and that straps should not be twisted.
- ! DO NOT install this enhanced infant child restraint without following the instructions in this manual or you may put your child at serious risk of injury or death.
- ! NEVER leave your child unattended with this enhanced infant child restraint.
- ! DO NOT make any modification to this enhanced infant child restraint or use it along with component parts from other manufacturers.
- ! DO NOT use this enhanced infant child restraint if it has damaged or missing parts.
- ! DO NOT have your child in large/oversized clothes because this may prevent your child from being properly and securely fastened by the shoulder harness straps and the crotch strap between the legs.
- ! DO NOT use this enhanced infant child restraint without the soft goods.
- ! The soft goods should not be replaced with any besides the ones recommended by the manufacturer. The soft goods constitute an integral part of the enhanced infant child restraint performance.
- ! DO NOT put anything other than the recommended inner cushions in this enhanced infant child restraint.
- ! Be sure that the enhanced infant child restraint is installed in such a way that no part of it interferes with movable seats or in the operation of vehicle doors.
- ! DO NOT continue to use this enhanced infant child restraint after it has suffered any type of crash, even a minor one. Replace immediately as there may be invisible, structural damage from the crash.
- ! Remove this infant carrier module and base from the vehicle seat when it is not in regular use.
- ! Consult the distributor for issues concerning maintenance, repair and part replacement.
- ! To avoid the risk of falling out, always secure the child using the child harness when the child is placed in infant carrier module, even when the enhanced infant child restraint is not in the vehicle.
- ! Before carrying the infant carrier module by hand, ensure that the child is fastened with the child harness, and that the handle is correctly locked in a vertical position.
- ! To avoid serious injury or death, NEVER place infant carrier module on elevated surface seat with child in it.
- ! The parts of this enhanced infant child restraint should not be lubricated in any way.
- ! Always secure child in enhanced infant child restraint, even on short trips, as this is when most accidents occur.
- ! Frequently check the ISOFIX guides for dirt and clean them if necessary. Reliability can be effected by ingress of dirt, dust, food particles etc.
- ! DO NOT leave this enhanced infant child restraint or other items unbelted or unsecured in your vehicle because an unsecured enhanced infant child restraint can be thrown around and may injure occupants in a sharp turn, sudden stop, or collision.
- ! DO NOT place a rear-facing enhanced infant child restraint on front seat with activated front airbag. Death or serious injury may occur. Please reference vehicle owner's manual for more information.
- ! DO NOT place any objects in the load leg area in front of your base.

- ! DO NOT use any load bearing contact points other than those described in the instructions and marked on the enhanced infant child restraint.
- ! Please do not use this enhanced child restraint if the enhanced child restraint has dropped from a significant height, hit the ground at a considerable speed, or has visible signs of damage. We are not responsible to replace if the car seat has been damaged under these abnormal conditions. A new car seat will need to be purchased when any of the aforementioned conditions occurs.

Emergency

In case of emergency or accidents, it is most important to have your child taken care of with first aid and medical treatment immediately.

Product Information

On i-Base Encore with the i-Size ISOFIX connections

1. This is an i-Size Enhanced Child Restraint System. It is approved according to UN Regulation No.129, for use in, i-Size compatible vehicle seating positions as indicated by vehicle manufacturers in the vehicle users' manual.
2. If in doubt, consult either the Enhanced Child Restraint System manufacturer or the retailer.



With vehicle belt

1. This is Universal Belted Enhanced Child Restraint System. It is approved according to UN Regulation NO 129. for use primarily in “Universal seating positions” as indicated by vehicle manufacturers in the vehicle user’s manual.
2. If in doubt, consult either the Enhanced Child Restraint System manufacturer or the retailer.

Materials Plastics, metal, fabrics

Patent No. Patents pending

Choose Your Installation

Figure for Installation	Suitable for
	<p>Child height 40cm-85cm/ Child weight ≤13kg (approximately 1.5 years old or under)</p>
	<p>Child height 40cm-85cm Child weight ≤13kg Child age ≤18 months</p>

Parts List

- | | | | |
|----|-------------------------------|----|--|
| 1 | Head Support | 15 | Rear Guide |
| 2 | Seat Pad | 16 | Stroller Fix Release Button B |
| 3 | Stroller Pad Release Button A | 17 | Infant Carrier Rotation Button |
| 4 | Side Guide | 18 | ISOFIX Adjustment Button |
| 5 | Infant Insert | 19 | Safe use indicator |
| 6 | Adjustment Webbing | 20 | Load Leg |
| 7 | Harness Adjustment Button | 21 | Load Leg Adjustment Button |
| 8 | Shoulder Harness | 22 | Instruction Manual Storage Compartment |
| 9 | Canopy Mount | 23 | ISOFIX Connector |
| 10 | Canopy | 24 | Child Restraint Release Button |
| 11 | Harness Connectors | 25 | ISOFIX Guides |
| 12 | Harness Buckle | | |
| 13 | Handle | | |
| 14 | Handle Button | | |

Please make sure there are no missing parts. Please contact the retailer if anything is missing.

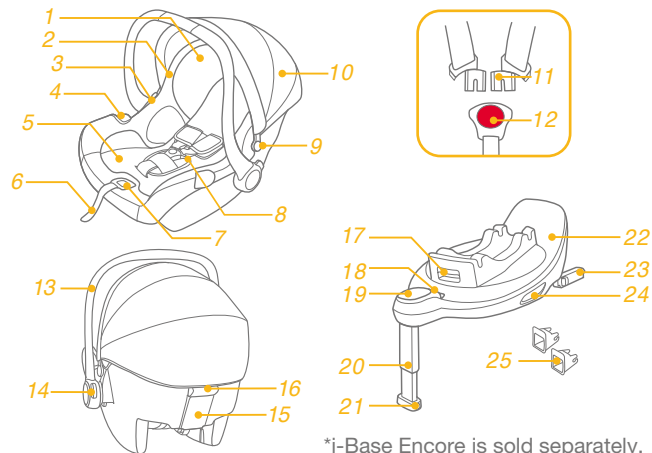

*i-Base Encore is sold separately.

Installation Concerns

- ! DO NOT install this infant carrier module on vehicle seats with Lap Belts. (Fig. 1)
- ! This Infant car seat is suitable for vehicle seats with a 3-point Retractor Safety Belt (with or without base) ONLY (Fig. 2), and i-SIZE ISOFIX anchor points with the base. (Fig. 3)
- ! DO NOT install this enhanced infant child restraint on vehicle seats that face sideways or rearward with respect to the moving direction of the vehicle. (Fig. 4.1)
- ! DO NOT place rear-facing enhanced infant child restraint on front seat with air bag (Fig. 4.2), because death or serious injury may occur. Please reference vehicle owner's manual for more information.
- ! It is recommended to install this enhanced infant child restraint on the rear vehicle seat. (Fig. 4.3)
- ! DO NOT install this enhanced infant child restraint on vehicle seats movable during installation.

Handle Adjustment

The handle of the infant carrier module can be adjusted to 3 positions. (Fig. 5)

- ! Position for car, hand or stroller transportation.

To adjust the handle, squeeze the handle buttons on both sides to release it, and then rotate the handle until it clicks into any of the 3 positions. (Fig. 6)

Installation with base

1. Attach the ISOFIX guides to the vehicle's ISOFIX anchor points (see vehicle owner's manual). (Fig. 7) The ISOFIX guides can protect the surface of the vehicle seat from being torn. They can also guide the ISOFIX connectors. (Fig. 8)
2. Unfold the load leg from storage compartment. (Fig. 8)
3. Extend the ISOFIX connectors by pressing the ISOFIX adjustment button while pulling on the connector. (Fig. 9)
4. Press the ISOFIX adjustment button to adjust the ISOFIX connectors. Line up the ISOFIX connectors with the ISOFIX guides, and then click both ISOFIX connectors into the ISOFIX anchor points. (Fig. 10)
 - ! Make sure that both ISOFIX connectors are securely attached to the vehicle's ISOFIX anchor points. There should be two audible clicks and the colors of the indicators on both ISOFIX connectors should be completely green. (Fig. 10.1)
 - ! Check to make sure the base is securely installed by pulling on both ISOFIX connectors.
5. After placing the base on the vehicle seat, extend the load leg to floor (Fig. 11) . When the load leg is installed correctly, the load leg indicator will show green. Red will be shown when installed incorrectly. (Fig. 11.2)
 - The load leg has multiple positions. When the load leg indicator shows red this means the load leg is in the wrong position.
 - ! Make sure the load leg is in full contact with the vehicle floor pan.
 - ! Squeeze the load leg adjustment button, then shorten the load leg upwards. (Fig. 11.1)
6. The completely assembled base is shown as (Fig. 12)
 - ! The ISOFIX connectors must be attached and locked onto the ISOFIX anchor points. (Fig. 12.1)

- ! The load leg must be installed correctly with green indicator. (Fig. 12.2)
 - ! Please install the enhanced child restraint on the rear vehicle seat and then put the child in the enhanced child restraint.
7. Push the enhanced child restraint down onto the base (Fig. 13). If the enhanced child restraint is secure, the enhanced child restraint indicator will show green. (Fig. 14)
 - ! The enhanced child restraint can ONLY be installed and released when in rearward facing mode.
 8. Press the rotating button to rotate for easier side loading/unloading of the child.(Fig. 15)
 - ! Rotate the enhanced child restraint to the rear facing position. The enhanced child restraint indicator will show green. (Fig. 16)
 9. To release the enhanced child restraint, first take the child out of the child restraint. Pull the child restraint release button (Fig. 17.1), then lift the child restraint up (Fig. 17.2).
 10. To remove the base from the vehicle seat, push the secondary lock buttons (Fig. 18.1) first and then press the ISOFIX releasing buttons (Fig. 18.2) on the ISOFIX connectors before removing the base from the vehicle seat. (Fig. 18)
 11. For transporting, press ISOFIX adjustment button and move the ISOFIX connectors back into the storage position. (Fig. 19)

Height Adjustment

for Head Support and Shoulder Harnesses

Check that Shoulder Harness Straps are set at the proper height. Please choose the proper pair of shoulder harness slots according to the child's height.

- ! The bottom of headrest must be level with the highest point of child's shoulder, it is shown as (Fig. 20), but not above the shoulder line. (Fig. 21)

- ! If the Shoulder Harness Straps are not at proper height, the child might be ejected from the enhanced infant child restraint if there is a crash.

Squeeze the head support adjustment lever (Fig. 22), meanwhile pull up or push down the head support until it snaps into one of the 7 positions. The head support positions are shown as (Fig. 23)

Securing Child in the enhanced Infant Child Restraint

Note

1. Infant insert is for children's protection. Children whose height is under 60cm are suitable to use the infant insert.
2. Before using the insert, please add the foam wedge. (Fig. 24)
3. After the child is placed in the seat, check if the shoulder harnesses are set to the correct height.



Remove the body portion of the infant insert when the infant's shoulders no longer fit comfortably.

1. While pressing the harness adjustment button, pull completely the two shoulder harnesses of the enhanced infant child restraint. (Fig. 25)
2. Unlock the buckle of the harnesses by pressing the red button. (Fig. 26)
3. Place child into the infant carrier module and lock the buckle. (Fig.27&Fig.28)
4. Tighten the shoulder harnesses by pulling adjustment webbing. (Fig. 29)

Detaching Canopy and Seat Pad

Follow steps (Fig. 30 - Fig. 35) to detach soft goods.

To re-assemble the soft goods, reverse the aforementioned steps.

Installation without base

! DO NOT install this infant carrier module on vehicle seats with Lap Belts.

! This infant carrier module is suitable for vehicle seats with a 3-point Retractor Safety Belt only.

1. Place the infant carrier module onto the vehicle seat where you wish to put it. Pull the vehicle safety belt out and lock it into the vehicle buckle, sliding the vehicle lap belt into the side guides of the infant carrier module. (Fig. 36)

! The infant carrier module can not be used if the vehicle safety belt buckle (female buckle end) is too long to anchor the infant carrier module securely. (Fig. 36.2)

2. Slide diagonal belt into the rear guide. (Fig. 37)

3. Pull the vehicle shoulder belt to fasten the infant carrier module tightly and securely. (Fig. 38)

4. Level line on infant carrier module must be level to the ground when the infant carrier module is installed. (Fig. 39)

! Tension the vehicle safety belt as much as possible, checking that it is not loose or twisted.

! After installing the infant carrier module, always check that the vehicle belts are routed correctly and securely fastened into the vehicle buckle. (Fig. 40)

5. The hood can be opened completely to protect your child from the sun uttermostly, just unzip the hook, and then pull the hood toward front. (Fig. 41)

Use with Strollers

Your enhanced infant child restraint is designed to attach to certain Joie stroller models featuring a special tray, armbar or calf support.

! Please make sure your stroller can fit the infant child restraint before purchasing it.

! Never allow more than one baby in the travel system at one time.

! Please brake your stroller before assembling the enhanced infant child restraint.

! Check that the parts used to fix the enhanced infant child restraint are securely fastened on the stroller.

! Recline the stroller seat back to the lowest position.

Use with Joie Strollers

To assemble the enhanced infant child restraint on Joie strollers, please follow these steps:

1. Place enhanced child restraint into stroller so notches in rockers fit over edge of armbar, tray or calf support. The enhanced child restraint will then automatically click into place. (Fig.42&Fig.43&Fig.44&Fig.45)

! If armbar has fabric cover, please detach the Velcro on armbar cover first. (Fig. 44.1)

! For the stroller with a special calf support, please adjust the calf support to the vertical position, detach the Velcro, and then lift the fabric cover. (Fig. 45.1)

2. Use the straps on both sides of stroller to fix the enhanced child restraint. (Fig.46&Fig.47&Fig.48)

! Try pulling the enhanced child restraint upwards to check that it is fitted correctly.

To remove the enhanced child restraint, release the straps from the enhanced child restraint, pull up the stroller release handle to release the enhanced child restraint from tray, armbar or calf support, and then lift enhanced child restraint out of stroller. Please refer to (Fig.49&Fig.50&Fig.51).

Care and Maintenance

- ! After removing the foam wedge of insert, please store it somewhere that the child cannot access it.
- ! Please wash the seat cover and inner padding with cold water under 30°C.
- ! Do not iron the soft goods.
- ! Do not bleach or dry clean the soft goods.
- ! Do not use undiluted detergents, gasoline or other organic solvent to wash the infant carrier module or base. It may cause damage to the enhanced infant child restraint.
- ! Do not twist the seat cover and inner padding in an attempt to dry. It may leave the seat cover and inner padding with wrinkles.
- ! Please hang dry the seat cover and inner padding in the shade.
- ! Please remove the enhanced infant child restraint and base from the vehicle seat if not in use for a long period of time. Put the enhanced infant child restraint in a cool, dry place and somewhere your child cannot access it.



Vehicle Fitting Information

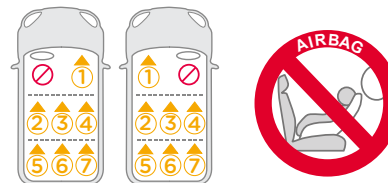

1. This is an i-Size Enhanced Child Restraint System. It is approved according to UN Regulation No.129, for use in, i-Size compatible vehicle seating positions as indicated by vehicle manufacturers in the vehicle users' manual.
2. If in doubt, consult either the Enhanced Child Restraint System manufacturer or the retailer.

ALWAYS give priority to the rear seats of your vehicle.

DO NOT use the rearward facing Enhanced Child Restraint System in seating positions where there is an active frontal airbag installed.

It is suitable to fix into seat positions in most cars. The numbers on the diagram below correspond with the vehicle fitting positions listed in the following pages.

If your enhanced child restraint can be fitted, it is marked with •



If your enhanced child restraint cannot be fitted, it is marked with ✘

i-Size vehicles are marked with 

If your vehicle is not listed in this manual or it is not marked with either a • or ✘ then please refer to your vehicle's handbook or contact the manufacturer for further information.

Alfa Romeo







① ② ③ ④ ⑤ ⑥ ⑦

4C Coupe (2014 >)	X	-	-	-	-	-	-
 Giulia (2017 >)	X	●	X	●	-	-	-
Giulietta (2010 >)	X	●	X	●	-	-	-
MiTo (2009 >)	X	●	-	●	-	-	-
 Stelvio (2017 >)	X	●	X	●	-	-	-

Aston Martin

DB11 (2019 >)	X	X	-	X	-	-	-
DBS (2019 >)	X	X	-	X	-	-	-
Vantage (2019 >)	X	-	-	-	-	-	-

Audi

A1 Sportback (2012 >)	X	●	X	●	-	-	-
A3 (1996 - 2003)	X	X	X	X	-	-	-
A3 2004 (2005 - 2011)	X	●	X	●	-	-	-
A3 Hatch (2012 >)	X	●	X	●	-	-	-
A3 S3 (2012 >)	X	●	X	●	-	-	-
A3 Saloon (2014 >)	X	●	X	●	-	-	-
A3 e-Tron Sportback (2015>)	X	●	X	●	-	-	-
A4 2005 (2005 - 2008)	X	●	X	●	-	-	-
 A4 2015 (2015 >)	X	●	X	●	-	-	-
A4 Avant (2008 >)	X	●	X	●	-	-	-
A5 Sportback (2009 >)	X	●	X	●	-	-	-
 A5/S5 Cabriolet 2017 (2017 >)	X	X	-	X	-	-	-
A5/S5 Coupe 2016 (2016 >)	X	●	X	●	-	-	-
 A5/S5 Sportback 2017 (2017 >)	X	●	X	●	-	-	-
A6 Allroad (2011 >)	X	●	X	●	-	-	-
A6 Avant (2011 >)	X	●	X	●	-	-	-
A7 Sportback (2011 >)	X	●	X	●	-	-	-
A7/S7 Sportback (2016 >)	X	●	X	●	-	-	-
A7/S7 Sportback 2018 (2018 >)	X	●	X	●	-	-	-
A8 (2011 >)	X	●	X	●	-	-	-
A8 S8 (2011 >)	X	●	X	●	-	-	-
 A8/S8 2018 (2018 >)	X	●	X	●	-	-	-
 Q2 (2016 >)	X	●	X	●	-	-	-
Q3 (2011 >)	X	●	X	●	-	-	-
 Q3 (2019 >)	X	●	X	●	-	-	-



① ② ③ ④ ⑤ ⑥ ⑦



Q5 (2009 >)	X	●	X	●	-	-	-
Q5/SQ5 2017 (2017 >)	X	●	X	●	-	-	-
Q7 (2006 >)	X	X	X	X	-	-	-
 Q7 2015 (2015 >)	X	●	X	●	X	-	X
 Q8 (2018 >)	X	●	X	●	-	-	-
TT Coupe (2008 >)	X	X	-	X	-	-	-







Bentley

Bentley Continental Flying Spur (2005 >)	X	●	X	●	-	-	-
Bentley Continental GT (2003 - 2012)	X	X	-	X	-	-	-
Bentley Continental GT Conv (2006 - 2012)	X	X	-	X	-	-	-
Bentley Mulsanne (2012 >)	X	●	X	●	-	-	-

BMW

1 Series (f20) (2011 >)	X	●	X	●	-	-	-
1-Series 5dr (2004 - 2010)	X	●	X	●	-	-	-
1-Series Cabrio (2008 >)	X	X	-	X	-	-	-
1-Series Coupe (2008 >)	X	●	-	●	-	-	-
2-Series AC-T (2015 >)	X	●	X	●	-	-	-
2-Series Coupe (2014 >)	X	●	-	●	-	-	-
3 Series (f30) (2012 >)	X	●	X	●	-	-	-
3-Series (E46) Coupe (2002 - 2006)	X	X	X	X	-	-	-
3-Series Coupe (E90) (2007 >)	X	●	-	●	-	-	-
4-Series Gran Coupe (2014 >)	X	●	X	●	-	-	-
5-GT (2010 >)	X	●	X	●	-	-	-
5-Series (F10) (2011 >)	X	●	X	●	-	-	-
5-Series (E60) (2003 - 2010)	X	●	X	●	-	-	-
 5-Series 2018 (2018 >)	X	●	X	●	-	-	-
6-Series Cabrio (2011 >)	X	●	-	●	-	-	-
6-Series Coupe (2Dr) (2011 >)	X	●	-	●	-	-	-
6-Series Gran Coupe (4Dr) (2011 >)	X	●	X	●	-	-	-
7-Series (2010 >)	X	●	X	●	-	-	-
7-Series 2015 (2015 >)	X	●	X	●	-	-	-
X1 (2009 -2015)	X	●	X	●	-	-	-
 X1 2016 (2016 >)	X	●	X	●	-	-	-
X3 (F25) (2011 >)	X	●	X	●	-	-	-
 X3 2018 (2018 >)	X	●	X	●	-	-	-
X4 (2014 >)	X	●	X	●	-	-	-
X5 2000 (2000 - 2006)	X	X	X	X	-	-	-
X5 2007 (2007 - 2014)	X	X	X	X	X	-	X

	1	2	3	4	5	6	7
X5 2015 (2015 >)	X	●	X	●	X	-	X
X6 (2009 >)	X	●	X	●	-	-	-
X6 2015 (2015 >)	X	●	-	●	-	-	-
i8 (2014 >)	X	X	-	X	-	-	-
Bmw 3GT (2013 >)	X	●	X	●	-	-	-
Bmw i3 (2014 >)	X	●	-	●	-	-	-
Cadillac							
Cadillac BLS (2005 - 2012)	X	●	X	●	-	-	-
Chevrolet							
Chevrolet Aveo 5 door (2012 >)	X	●	X	●	-	-	-
Chevrolet Captiva (2010 >)	X	●	X	●	-	-	-
Chevrolet Cruze (2011 >)	X	●	X	●	-	-	-
Chevrolet Orlando (2011 >)	X	●	X	●	-	-	-
Chevrolet Spark 5Dr (2012 >)	X	X	X	X	-	-	-
Chevrolet Traxx (2013 >)	X	●	X	●	-	-	-
Chevrolet Volt (2011 >)	X	●	-	●	-	-	-
Chrysler							
300C (2012 >)	X	●	X	●	-	-	-
Delta (2007 >)	X	●	X	●	-	-	-
Grand Voyager (2008 >)	X	●	-	●	X	X	X
Ypsilon (2012 >)	X	●	X	●	-	-	-
Citroen							
Berlingo II (2008 >)	X	●	X	●	-	-	-
Berlingo Multispace (2007 >)	X	X	X	X	X	-	X
 C-Cactus (2015)	X	●	X	●	-	-	-
C1 (2006 >)	X	X	-	X	-	-	-
C1 2015 (2015 >)	X	X	-	X	-	-	-
C3 5Dr (2009 >)	X	●	X	●	-	-	-
C3 5Dr 2005 (2005 - 2009)	X	●	X	●	-	-	-
 C3 5Dr 2016 (2016 >)	X	●	X	●	-	-	-
 C3 Aircross (2017 >)	X	●	X	●	-	-	-
C3 Picasso (2009 >)	X	●	X	●	-	-	-
C4 G-Picasso (2014 >)	X	X	X	X	-	-	X
C4 G-Picasso 2007 (2007 - 2013)	X	X	●	X	X	-	X

	1	2	3	4	5	6	7
C4 Picasso (2007 - 2013)	X	X	X	X	-	-	-
C5 (2008 >)	X	●	X	●	-	-	-
C5 2005 (2005 - 2008)	X	●	X	●	-	-	-
 C5 Aircross (2019 >)	X	X	X	X	-	-	-
C5 Tourer (2009 >)	X	●	X	●	-	-	-
DS3 (2011 >)	X	●	X	●	-	-	-
DS3 Cabrio (2013 >)	X	●	X	●	-	-	-
 DS3 Crossback (2019 >)	X	●	X	●	-	-	-
DS4 (2011 >)	X	●	X	●	-	-	-
DS5 (2013 >)	X	●	X	●	-	-	-
 DS7 (2018 >)	X	●	X	●	-	-	-
Jumpy (2007 - 2016)	X	●	X	●	X	-	X
Nemo (2008 >)	X	●	X	●	-	-	-
Xsara 5Dr (2000 - 2004)	X	X	X	X	-	-	-
Xsara Picasso (2000 - 2012)	X	X	X	X	-	-	-
Dacia							
Duster (2012 >)	X	●	X	●	-	-	-
Logan MCV (2013 >)	X	X	X	X	-	-	-
Logan MCV 2006 (2008/11-2013/7)	X	X	X	X	-	-	-
Sandero (2013 >)	X	X	X	X	-	-	-
Fiat							
124 Spider 2016 (2016 >)	X	-	-	-	-	-	-
500 (2008 >)	X	X	-	X	-	-	-
500L (2013 >)	X	●	X	●	-	-	-
 500X (2015 >)	X	●	X	●	-	-	-
Bravo (2007 >)	X	●	X	●	-	-	-
Doblo (2007 >)	X	●	X	●	-	-	-
Panda (2012 >)	X	X	X	X	-	-	-
Punto 3 Door (Grande Punto) (2006 >)	X	X	X	X	-	-	-
Qubo (2008 >)	X	●	X	●	-	-	-
 Tipo 2016 (2016 >)	X	●	X	●	-	-	-
Ford							
 Galaxy 2016 (2016 >)	X	X	X	X	X	-	X
B-Max (2012 >)	X	●	X	●	-	-	-
C-Max (2003 - 2013)	X	X	X	X	-	-	-
C-Max 2013 (2011 >)	X	X	X	X	-	-	-

	1	2	3	4	5	6	7
EcoSport (2015 >)	X	•	X	•	-	-	-
Edge (2016 >)	X	•	X	•	X	-	X
Fiesta 2004 3Dr (2004 - 2008)	X	X	X	X	-	-	-
Fiesta 2008 (2008 >)	X	•	X	•	-	-	-
Fiesta 2017 > (2017 >)	X	•	X	•	-	-	-
Focus (2010 >)	X	•	X	•	-	-	-
Focus 2005 (2005 - 2009)	X	X	X	X	-	-	-
Focus 2018 (2018 >)	X	•	X	•	-	-	-
Focus EV (2015>)	X	•	X	•	-	-	-
Focus Mk1 (1998 - 2004)	X	X	X	X	-	-	-
Galaxy (2006 >)	X	X	X	X	X	-	X
Ka (2009 - 2013)	X	X	-	X	-	-	-
Ka+ 2016 (2016 >)	X	•	X	•	-	-	-
Kuga 2008 (2008 - 2012)	X	•	X	•	-	-	-
Kuga 2013 (2013 >)	X	•	X	•	-	-	-
Kuga 2017 (2017 >)	X	•	X	•	-	-	-
Kuga 2020 (2020 >)	X	•	X	•	-	-	-
Mondeo 2000 (2000 - 2007)	X	X	X	X	-	-	-
Mondeo Estate (2007 >)	X	•	X	•	-	-	-
Mustang Cabrio 2015 (2015 >)	X	X	-	X	-	-	-
Mustang Coupe 2015 (2015 >)	X	X	-	X	-	-	-
New Mondeo 2014 (2014 >)	X	•	X	•	-	-	-
Puma (2020 >)	X	•	X	•	-	-	-
Ranger Double-Cab Pickup (2019 >)	X	•	X	•	-	-	-
S-Max (2006 >)	X	X	X	X	X	-	X
S-Max 2015 (2015 >)	X	X	X	X	X	-	X

Honda

Accord Saloon (2008 >)	X	•	X	•	-	-	-
CR-V (2007 - 2012)	X	•	X	•	-	-	-
CR-V 2012 (2012 >)	X	•	X	•	-	-	-
CR-V 2019 (2019 >)	X	•	X	•	X	-	X
Civic (2012 >)	X	•	X	•	-	-	-
Civic (2006 - 2011)	X	•	X	•	-	-	-
Civic 2017 (2017 >)	X	•	X	•	-	-	-
Civic Saloon 2019 (2019 >)	X	•	X	•	-	-	-
Civic Tourer (2014 >)	X	•	X	•	-	-	-
Elysion (2012 >)	X	•	-	•	X	X	X
FRV (2006 - 2011)	X	X	X	X	-	-	-
HR-V (2015 >)	X	•	X	•	-	-	-
Insight (2009 >)	X	X	X	X	-	-	-

Hyundai











	1	2	3	4	5	6	7
Jazz (2008 - 2015)	X	•	X	•	-	-	-
Jazz 2002 (2002 - 2008)	X	X	X	X	-	-	-
Jazz 2016 (2016 >)	X	•	X	•	-	-	-
Jazz 2020 (2020 >)	X	•	X	•	-	-	-
Odyssey (2010 >)	X	X	-	X	-	-	-
Genesis Sedan (2016 >)	X	•	X	•	-	-	-
Getz (2005 - 2011)	X	•	X	•	-	-	-
Ioniq Hybrid (2016 >)	X	•	X	•	-	-	-
Ix20 (2011 >)	X	•	X	•	-	-	-
Kona 2017 > (2017 >)	X	•	X	•	-	-	-
Santa Fe (2012 >)	X	•	X	•	X	-	X
Santa Fe 2007 (2007 - 2012)	X	•	X	•	X	-	X
Tucson 2015 (2015 >)	X	•	X	•	-	-	-
Veloster (2012 >)	X	•	-	•	-	-	-
i10 (2008 >)	X	X	X	•	-	-	-
i10 2014 (2014 >)	X	X	X	•	-	-	-
i20 2014 > (2014 >)	X	•	X	•	-	-	-
i20 2015 (2015 >)	X	•	X	•	-	-	-
i20 Hatch (2009 >)	X	•	X	•	-	-	-
i30 Hatch (2012 >)	X	•	X	•	-	-	-
i30 Hatch 2015 (2015 - 2017)	X	•	X	•	-	-	-
i30 Hatch 2017 (2017 >)	X	•	X	•	-	-	-
i40 (2011 >)	X	•	X	•	-	-	-
i800/H1 (2008 >)	X	•	X	•	X	X	X
ix35 (2010 >)	X	•	X	•	-	-	-









Infiniti

EX SUV (2009 >)	X	•	X	•	-	-	-
FX SUV (2009 >)	X	•	X	•	-	-	-
G Coupe (2009 >)	X	X	-	X	-	-	-
G Saloon (2009 >)	X	•	X	•	-	-	-
M Saloon (2010 >)	X	•	X	•	-	-	-



Jaguar

E-Pace (2018 >)	X	•	X	•	-	-	-
F-Pace (2016 >)	X	•	X	•	-	-	-
F-Type Coupe (2014 >)	X	-	-	-	-	-	-









	1	2	3	4	5	6	7
 i-Pace (2018 >)	X	●	X	●	-	-	-
X-Type (2001 - 2010)	X	X	X	X	-	-	-
 XE (2015 >)	X	●	X	●	-	-	-
XF (2008 >)	X	●	X	●	-	-	-
 XF 2015 (2015 >)	X	●	X	●	-	-	-
 XF Estate 2015 (2015 >)	X	●	X	●	-	-	-
XF Sportbrake (2012 >)	X	●	X	●	-	-	-
XJ (2010 >)	X	●	X	●	-	-	-
XK Coupe (2006 >)	X	X	-	X	-	-	-
Jeep							
Cherokee 2014 (2014 >)	X	●	X	●	-	-	-
Compass (2011 >)	X	●	X	●	-	-	-
Grand Cherokee (2011 >)	X	●	X	●	-	-	-
 Renegade 2015 (2015 >)	X	●	X	●	-	-	-
Wrangler 5Dr (2007 >)	X	X	X	X	-	-	-
Kia							
Sorento 2015 (2015 >)	X	●	X	●	X	-	X
Soul EV (2015 >)	X	●	X	●	-	-	-
Carens 2013 (2013 >)	X	X	X	X	X	-	X
Cee'D Hatch (2012 >)	X	●	X	●	-	-	-
Cee'D Hatch (2012 >)	X	●	X	●	-	-	-
 Niro 2017 > (2017 >)	X	●	X	●	-	-	-
Optima (2011 >)	X	●	X	●	-	-	-
 Optima 2016 (2016 >)	X	●	X	●	-	-	-
Picanto (2008 >)	X	X	X	X	-	-	-
Picanto 2012 (2011 - 2015)	X	●	X	●	-	-	-
 Picanto 2017 > (2017 >)	X	●	X	●	-	-	-
Rio (2012 >)	X	●	X	●	-	-	-
 Rio 2017 > (2017 >)	X	●	X	●	-	-	-
Sorento (2012 >)	X	●	X	●	-	-	-
Sorento (2003 - 2009)	X	●	X	●	-	-	-
Soul (2009 >)	X	●	X	●	-	-	-
Sportage (2011 >)	X	●	X	●	-	-	-
 Sportage 2016 (2016 >)	X	●	X	●	-	-	-
 Stonic 2017 > (2017 >)	X	●	X	●	-	-	-
Venga (2011 >)	X	●	X	●	-	-	-

	1	2	3	4	5	6	7
Lancia							
Thema (2012 >)	X	●	X	●	-	-	-
Voyager (2010 >)	X	●	-	●	X	X	X
Ypsilon (2012 >)	X	●	X	●	-	-	-
Land Rover							
 Defender 2020 (2020 >)	X	●	X	●	X	-	X
Discovery 4 (2009 >)	X	X	X	X	-	-	-
 Discovery 5 2017 (2017 >)	X	●	X	●	X	-	X
Discovery Sport (2015 >)	X	●	X	●	X	-	X
Freelander 2 (2006 >)	X	●	X	●	-	-	-
Range Rover (2002 - 2012)	X	●	X	●	-	-	-
Range Rover 2013 (2013 >)	X	●	X	●	-	-	-
Range Rover Evoque (2011 >)	X	●	X	●	-	-	-
 Range Rover Evoque (5dr) 2019 (2019 >)	X	●	X	●	-	-	-
Range Rover Evoque 5 door (2011 >)	X	●	X	●	-	-	-
Range Rover Sport (2005 - 2012)	X	●	X	●	-	-	-
Range Rover Sport (2013 >)	X	●	X	●	-	-	-
 Range Rover VELAR (2017 >)	X	●	X	●	-	-	-
Lexus							
CT (2011 >)	X	●	X	●	-	-	-
 ES Hybrid (2019 >)	X	●	X	●	-	-	-
GS (2013 >)	X	●	X	●	-	-	-
IS (2005 >)	X	●	X	●	-	-	-
IS 200 (2004) (1999 >)	X	●	X	●	-	-	-
 NX (2014 >)	X	●	X	●	-	-	-
RX (2010 >)	X	●	X	●	-	-	-
 RX 2016 (2017 >)	X	●	X	●	-	-	-
 UX (2019 >)	X	●	X	●	-	-	-
Maserati							
Maserati Ghibli 2014 (2014 >)	X	●	X	●	-	-	-
Gran Turismo 2007 (2007 >)	X	X	-	X	-	-	-
Levante (2017 >)	X	●	X	●	-	-	-
Quattroporte 2016 (2016 >)	X	●	X	●	-	-	-

Mazda

	①	②	③	④	⑤	⑥	⑦
2 (2007 >)	X	●	X	●	-	-	-
 2 2015 (2015 >)	X	●	X	●	-	-	-
3 Hatch (2009 - 2013)	X	●	X	●	-	-	-
3 Hatchback 2014 (2014 >)	X	●	X	●	-	-	-
5 (2005 - 2010)	X	●	X	●	-	-	-
6 (2007 - 2012)	X	●	X	●	-	-	-
 6 2018 (2018 >)	X	●	X	●	-	-	-
6 Estate (2013 >)	X	●	X	●	-	-	-
6 Saloon (2013 >)	X	●	X	●	-	-	-
 CX-3 (2015 >)	X	●	X	●	-	-	-
CX-5 (2011 >)	X	●	X	●	-	-	-
CX-7 (2007 >)	X	●	X	●	-	-	-
MX-5 2015 (2016 >)	X	-	-	-	-	-	-

Mercedes-Benz



A Class (2005 - 2012)	X	●	X	●	-	-	-
A-Class (2013 >)	X	●	X	●	-	-	-
 A-Class Hatchback 2019 (2019 >)	X	●	X	●	-	-	-
 A-Class Saloon 2019 (2020 >)	X	●	X	●	-	-	-
B-Class (2012 >)	X	X	X	X	-	-	-
B-Class EV (2015 >)	X	X	X	X	-	-	-
C-Class 2015 Estate (2015 >)	X	X	X	X	-	-	-
C-Class Coupe (2011 >)	X	●	-	●	-	-	-
C-Class Estate (2008 >)	X	●	X	●	-	-	-
CLA (2013 >)	X	●	X	●	-	-	-
 CLA 2019 (2020 >)	X	●	X	●	-	-	-
 CLA Shooting-Brake (2015 >)	X	●	X	●	-	-	-
CLS Coupe (2011 >)	X	●	X	●	-	-	-
CLS Shooting Brake (2012 >)	X	●	X	●	-	-	-
E-Class 2006 (2006 - 2009)	X	●	X	●	-	-	-
E-Class Cabriolet 2017 (2017 >)	X	●	-	●	-	-	-
E-Class Coupe (2009 >)	X	X	-	X	-	-	-
 E-Class Coupe 2017 (2017 >)	X	●	-	●	-	-	-
E-Class Estate (2013 >)	X	●	X	●	-	-	-
 E-Class Estate 2016 (2016 >)	X	●	X	●	-	-	-
E-Class Saloon 2013 (2013 >)	X	●	X	●	-	-	-
GL Class (2012 >)	X	●	X	●	X	-	X
 GLC (2016 >)	X	●	X	●	-	-	-
 GLC Coupe (2019 >)	X	●	X	●	-	-	-

MG

	①	②	③	④	⑤	⑥	⑦
GLE (2015 >)	X	●	X	●	-	-	-
ML-Class (2005 - 2012)	X	●	X	●	-	-	-
R-Class (2006 - 2012)	X	X	X	X	-	-	-
S Class 2015 (2014 >)	X	●	X	●	-	-	-
S-Class (2006 - 2013)	X	●	X	●	-	-	-
SL-Class (2012 >)	X	-	-	-	-	-	-
SLK (2012 >)	X	-	-	-	-	-	-
V-Class (2015 >)	X	●	X	●	X	X	X

 GS (2016 >)	X	●	X	●	-	-	-
Motor MG6 (2012 >)	X	●	X	●	-	-	-

Mini

Countryman (2010 >)	X	●	X	●	-	-	-
Coupe (2009 >)	X	-	-	-	-	-	-
Hatch (2006 >)	X	X	-	X	-	-	-
Hatchback 3Dr 2014 (2014 >)	X	X	-	X	-	-	-
Hatchback 3dr (2000 - 2006)	X	X	-	X	-	-	-
Hatchback 5dr 2015 (2015 >)	X	●	X	●	-	-	-
Paceman (2013 >)	X	X	-	X	-	-	-
 Clubman 2016 (2016 >)	X	●	X	●	-	-	-
 Countryman 2017 (2017 >)	X	●	X	●	-	-	-

Mitsubishi

ASX (2010 >)	X	●	X	●	-	-	-
Colt (2007 - 2013)	X	●	X	●	-	-	-
 Eclipse Cross (2019 >)	X	●	X	●	-	-	-
Lancer (2008 - 2011 >)	X	●	-	●	-	-	-
Lancer Sportback (2008 - 2011 >)	X	●	-	●	-	-	-
Mirage (2012 >)	X	X	X	X	-	-	-
Outlander (2007 - 2013)	X	●	X	●	-	-	-
Outlander (2013 >)	X	●	X	●	-	-	-
Outlander PHEV (2015 >)	X	●	X	●	-	-	-
Shogun (2007 >)	X	●	X	●	-	-	-

Nissan

2008 X-Trail (2008 >)	X	●	X	●	-	-	-
-----------------------	---	---	---	---	---	---	---







	1	2	3	4	5	6	7
Juke (2010 >)	X	●	X	●	-	-	-
Leaf EV (2010 - 2017)	X	●	X	●	-	-	-
Micra (2011 >)	X	●	X	●	-	-	-
Micra 2017 > (2017 >)	X	●	X	●	-	-	-
Murano 2016 (2016 >)	X	●	X	●	-	-	-
Navara 2015 > (2015 >)	X	●	X	●	-	-	-
Note (2006 - 2013)	X	●	X	●	-	-	-
Note 2014 (2014 >)	X	●	X	●	-	-	-
Pulsar 2015 (2015 >)	X	●	X	●	-	-	-
Qashqai 2007 (2006 -2013)	X	●	X	●	-	-	-
Qashqai 2014 (2014 >)	X	●	X	●	-	-	-
Qashqai+2 (2008 >)	X	●	X	●	-	-	-
Quest MPV (2012 >)	X	●	-	●	X	X	X
X-Trail 2015 (2015 >)	X	●	X	●	X	-	X

Opel

Adam (2013 >)	X	X	-	X	-	-	-
Agila (2008 >)	X	●	X	●	-	-	-
Ampera (2011 >)	X	●	-	●	-	-	-
Antara (2007 >)	X	●	X	●	-	-	-
Astra 2003 5dr (2003 - 2009)	X	●	X	●	-	-	-
Astra 2010 5 door (2010 >)	X	X	X	X	-	-	-
 Astra 2015 (2015 >)	X	●	X	●	-	-	-
Astra GTC (2011 >)	X	●	X	●	-	-	-
Corsa 5dr 2015 (2015 >)	X	●	X	●	-	-	-
Corsa Hatch 5 door (2006 >)	X	●	X	●	-	-	-
Insignia Hatch (2009 >)	X	●	X	●	-	-	-
Karl (2015 >)	X	●	X	●	-	-	-
Meriva (2010 >)	X	X	X	X	-	-	-
Mokka (2013 >)	X	●	X	●	-	-	-
Vectra 2005 (2002 - 2008)	X	●	X	●	-	-	-
Zafira (2005 >)	X	●	X	●	-	-	-
Zafira Tourer (2012 >)	X	X	X	X	X	-	X

Peugeot

107 (2005 - 2013)	X	●	-	●	-	-	-
108 (2015 >)	X	●	-	●	-	-	-
2008 (2013 >)	X	●	X	●	-	-	-
 2008 2020 (2020 >)	X	●	X	●	-	-	-
206 3Dr (1998 - 2009)	X	●	X	●	-	-	-

	1	2	3	4	5	6	7
207 3 Door Hatchback (2006 - 2012)	X	●	X	●	-	-	-
207 5 Door (2012 >)	X	●	X	●	-	-	-
 208 2020 5dr (2020 >)	X	●	X	●	-	-	-
208 5DR (2012 >)	X	●	X	●	-	-	-
 208 EV 2020 5dr (2020 >)	X	●	X	●	-	-	-
3008 (2009 >)	X	●	X	●	-	-	-
 3008 2017 (2017 >)	X	●	X	●	-	-	-
307 Hatchback (2001 - 2007)	X	●	X	●	-	-	-
308 (2014) (2014 >)	X	●	X	●	-	-	-
308 Hatchback (2007 >)	X	●	X	●	-	-	-
407 (2004 - 2011)	X	●	X	●	-	-	-
5008 (2011 >)	X	X	●	X	X	-	X
 5008 (2018 >)	X	X	●	X	X	-	X
508 (2011 >)	X	●	X	●	-	-	-
 508 2019 (2018 >)	X	●	X	●	-	-	-
 508 Estate PHEV 2019 (2019 >)	X	●	X	●	-	-	-
Bipper Teepee (2008 >)	X	●	X	●	-	-	-
Expert Teepee (2008 >)	X	●	X	●	X	-	X
Partner Combi (2004 - 2010)	X	X	X	X	-	-	-
Partner Teepee (2008 >)	X	●	X	●	-	-	-
RCZ (2011 >)	X	X	-	X	-	-	-
Traveller 2016 (2016 >)	X	●	●	●	●	●	●

Porsche

Cayenne (2011 >)	X	●	X	●	-	-	-
 Cayenne 2017 (2017 >)	X	●	X	●	-	-	-
Cayenne E-Hybrid (2015 >)	X	●	X	●	-	-	-
Macan (2014 >)	X	●	X	●	-	-	-
Panamera (2011 >)	X	●	-	●	-	-	-
Panamera E-Hybrid (2015 >)	X	●	-	●	-	-	-

Renault

Captur (2015 >)	X	X	X	X	-	-	-
Clio (2005 - 2013)	X	●	X	●	-	-	-
Espace (2003 - 2012)	X	X	●	X	X	-	X
Grand Espace (2003 - 2012)	X	X	●	X	X	-	X
Kadjar (2015 >)	X	●	X	●	-	-	-
Laguna Sport Tourer (2008 - 2012)	X	●	X	●	-	-	-
Megane Hatch (2008 >)	X	●	X	●	-	-	-
Megane Hatch (2002 - 2009)	X	●	X	●	-	-	-

	1	2	3	4	5	6	7
Megane Hatch 2016 (2016 >)	X	●	-	●	-	-	-
Modus (2004 - 2012)	X	●	-	●	-	-	-
New Clio (2013 >)	X	●	-	●	-	-	-
Scenic (2009 >)	X	X	X	X	-	-	-
Scenic 2003 (2003 - 2009)	X	X	X	X	-	-	-
Scenic 2017 (2017 >)	X	X	X	X	-	-	-
Twingo (2007 >)	X	X	-	X	-	-	-
Twingo 2015 (2015 >)	X	●	-	●	-	-	-

Rover

25 / Streetwise (1999 - 2005)	X	X	-	X	-	-	-
-------------------------------	---	---	---	---	---	---	---

SAAB

93 Sport Wagon (2005 - 2012)	X	●	X	●	-	-	-
New 95 (2011 - 2012)	X	●	X	●	-	-	-

SEAT

Alhambra (2010 >)	X	●	●	●	X	-	X
Altea (2004 - 2012)	X	●	X	●	-	-	-
Arosa (1997 - 2004)	X	X	-	X	-	-	-
Ateca 2018 (2018 >)	X	X	X	X	-	-	-
Exeo ST (2008 >)	X	●	X	●	-	-	-
Ibiza 2018 (2018 >)	X	●	X	●	-	-	-
Ibiza HATCH 5 door (2008 - 2013)	X	●	X	●	-	-	-
Leon FR (2006 - 2012)	X	●	X	●	-	-	-
Leon (2000 - 2005)	X	X	X	X	-	-	-
New Toledo (2013 >)	X	●	X	●	-	-	-
mii (2011 >)	X	X	X	X	-	-	-
Leon 2013 (2013 >)	X	●	X	●	-	-	-

Skoda

Citigo (2011 >)	X	X	X	X	-	-	-
Citigo 5dr (2012 >)	X	X	-	X	-	-	-
Fabia 2015 (2015 >)	X	●	X	●	-	-	-
Fabia Hatch (2007 >)	X	X	X	X	-	-	-
Karoq 2017 > (2017 >)	X	X	X	X	-	-	-
Kodiaq 2017 > (2017 >)	X	●	X	●	X	-	X
Octavia (2004 - 2012)	X	●	X	●	-	-	-

	1	2	3	4	5	6	7
Octavia Hatch 2013 (2013 >)	X	●	X	●	-	-	-
Rapid (2013 >)	X	●	X	●	-	-	-
Roomster (2006 >)	X	X	X	X	-	-	-
Superb 2015 (2015 >)	X	●	X	●	-	-	-
Superb Combi/Estate (2008 >)	X	●	X	●	-	-	-
Yeti (2009 >)	X	X	X	X	-	-	-

Smart

For Two Coupe (2007 - 2011)	X	-	-	-	-	-	-
FourFour 2015 (2015 >)	X	X	-	X	-	-	-

Ssangyong

Actyon (2006 - 2011)	X	●	X	●	-	-	-
Korando (2011 >)	X	●	X	●	-	-	-
Musso Pickup 2016 (2016 >)	X	●	-	●	-	-	-
Rexton (2014 - 2016)	X	●	X	●	-	-	-
Tivoli (2015 >)	X	●	X	●	-	-	-
Turismo (2014 >)	X	●	-	●	X	X	X

Subaru







BRZ (2012 >)	X	X	-	X	-	-	-
Forester (2013 >)	X	●	X	●	-	-	-
Impreza 5dr (2007 >)	X	X	X	●	-	-	-
Impreza Hatchback 2013 (2013 >)	X	●	X	●	-	-	-
Legacy (2012 >)	X	●	X	●	-	-	-
Levorg 2014 (2014 >)	X	●	X	●	-	-	-
Outback (2012 >)	X	●	X	●	-	-	-
XV Hatchback (2011 >)	X	●	X	●	-	-	-

Suzuki

Alto (2009 >)	X	X	-	X	-	-	-
Baleno 2016 (2016 >)	X	●	X	●	-	-	-
Celerio 2016 (2015 >)	X	X	X	X	-	-	-
Grand Vitara (2005 >)	X	X	X	●	-	-	-
Ignis 2016 (2016 >)	X	●	-	●	-	-	-
SX-4 5dr (2006 >)	X	●	X	●	-	-	-
Splash (2008 >)	X	X	X	X	-	-	-
Swift 2017 (2017 >)	X	●	X	●	-	-	-
Swift Sport 5dr (2011 >)	X	●	X	●	-	-	-





① ② ③ ④ ⑤ ⑥ ⑦

① ② ③ ④ ⑤ ⑥ ⑦







	Vitara 2015 (2015 >)	X	●	X	●	-	-	-
Tesla								
	Model S (2012 >)	X	●	X	●	-	-	-
	Model X (2015 >)	X	●	-	●	X	-	X
Toyota								
	2013 Verso (2013 >)	X	X	X	X	-	-	-
	Auris (2007 - 2013)	X	●	X	●	-	-	-
	Auris (2013 >)	X	●	X	●	-	-	-
	Avensis Hatch (2003 - 2011)	X	●	X	●	-	-	-
	Aygo 2014 (2014 >)	X	X	-	X	-	-	-
	 Aygo 2019 (2019 >)	X	X	-	X	-	-	-
	Aygo 3 Door (2005 >)	X	X	-	X	-	-	-
	 C-HR (2017 >)	X	●	X	●	-	-	-
	 Corolla 2018 (2018 >)	X	●	X	●	-	-	-
	EZ Mpv (2013 >)	X	X	X	X	-	-	-
	GT86 (2012 >)	X	X	-	X	-	-	-
	Highlander (2013 >)	X	●	X	●	-	-	-
	Land Cruiser (2003 - 2009)	X	●	X	●	-	-	-
	Landcruiser (2009 >)	X	●	X	●	-	-	-
	Prius 2 (2004 - 2009)	X	●	X	●	-	-	-
	Prius 3 (2010 >)	X	●	X	●	-	-	-
	 Prius 4 (2016) (2015 >)	X	●	X	●	-	-	-
	Prius PHEV 3 (2015 >)	X	●	X	●	-	-	-
	Prius Plus+ (2012 >)	X	X	X	X	-	-	-
	RAV 4 (2006 - 2012)	X	●	X	●	-	-	-
	RAV4 (2013 >)	X	●	X	●	-	-	-
	 RAV4 2019 (2019 >)	X	●	X	●	-	-	-
	 RAV4 Hybrid (2015 >)	X	●	X	●	-	-	-
	RAV4 Hybrid (2015 >)	X	●	X	●	-	-	-
	Verso (2009 - 2012)	X	X	X	X	-	-	-
	Yaris 2017 > (2017 >)	X	●	X	●	-	-	-
	 Yaris 2019 (2019 >)	X	●	X	●	-	-	-
	Yaris Hatch (2011 >)	X	●	X	●	-	-	-
	Yaris Hatch (2006 - 2011)	X	●	X	●	-	-	-

Vauxhall

Adam (2013 >) X X - X - - -









	Agila (2008 >)	X	●	X	●	-	-	-
	Ampera (2011 >)	X	●	-	●	-	-	-
	Antara (2007 >)	X	●	X	●	-	-	-
	Astra 2010 5 door (2010 >)	X	X	X	X	-	-	-
	 Astra 2015 (2015 >)	X	●	X	●	-	-	-
	Astra GTC (2011 >)	X	●	X	●	-	-	-
	Astra Saloon (1998 - 2004)	X	X	X	X	-	-	-
	Corsa 5dr 2015 (2015 >)	X	●	X	●	-	-	-
	Corsa Hatch 5 door (2006 >)	X	●	X	●	-	-	-
	Insignia Hatch (2009 >)	X	●	X	●	-	-	-
	Meriva (2010 >)	X	X	X	X	-	-	-
	Mokka (2013 >)	X	●	X	●	-	-	-
	Vectra 2005 (2005 - 2008)	X	●	X	●	-	-	-
	Viva (2015 >)	X	X	X	X	-	-	-
	Zafira (2005 >)	X	●	X	●	-	-	-
	 Zafira Tourer (2012 >)	X	X	X	X	X	-	X
	 Opel Crossland X (2018 >)	X	●	X	●	-	-	-
	 Opel Grandland X (2019 >)	X	●	X	●	-	-	-
	 Opel Insignia 2018 (2018 >)	X	●	X	●	-	-	-

Volvo

	C30 (2007 - 2013)	X	X	-	X	-	-	-
	S40 (2004 - 2012)	X	●	X	●	-	-	-
	 S90 2016 (2016 >)	X	●	X	●	-	-	-
	V40 (2013 >)	X	●	X	●	-	-	-
	V40 Cross County (2013 >)	X	●	X	●	-	-	-
	V50 (2004 - 2012)	X	●	X	●	-	-	-
	V60 (2011 >)	X	●	X	●	-	-	-
	V60 Plug-In (2015 >)	X	●	X	●	-	-	-
	 V60 (2018 >)	X	●	X	●	-	-	-
	 v90 2016 (2016 >)	X	●	X	●	-	-	-
	 XC40 (2018 >)	X	●	X	●	-	-	-
	XC60 (2013 >)	X	●	X	●	-	-	-
	 XC60 2017 (2017 >)	X	●	X	●	-	-	-
	XC70 (2008 >)	X	●	X	●	-	-	-
	XC90 (2003 - 2015)	X	X	X	X	-	-	-
	 XC90 2016 (2016 >)	X	●	X	●	X	-	X

VW

 Arteon 2017 > (2017 >) X X X X - - -

	①	②	③	④	⑤	⑥	⑦
Beetle (2012 >)	X	•	-	•	-	-	-
Beetle 1999 (1999 - 2005)	X	X	-	X	-	-	-
Caddy Maxilife (2010 >)	X	•	X	•	X	-	X
E-Golf Hatch Mk7 (2015>)	X	•	X	•	-	-	-
E-UP! (2015>)	X	•	X	•	-	-	-
Golf Cabriolet (2009 >)	X	X	-	X	-	-	-
Golf GTE Hatch Mk7 (2015>)	X	•	X	•	-	-	-
Golf Hatch (2009 - 2013)	X	•	X	•	-	-	-
Golf Hatch Mk5 (2004 - 2008)	X	•	X	•	-	-	-
Golf Hatch Mk7 (2012 >)	X	•	X	•	-	-	-
Golf Plus (2009 - 2013)	X	•	X	•	-	-	-
Jetta (2011 >)	X	•	X	•	-	-	-
Lupo (1999 - 2005)	X	X	-	X	-	-	-
Multivan Caravelle (2008 >)	X	•	-	•	•	X	•
Passat CC (2008 >)	X	•	X	•	-	-	-
Passat Estate (2005 - 2011)	X	•	X	•	-	-	-
Passat Estate (2011-2015)	X	•	X	•	-	-	-
 Passat Estate 2015 (2015 >)	X	•	X	•	-	-	-
Passat Saloon (2005 - 2011)	X	•	X	•	-	-	-
Passat Saloon (2011-2015)	X	•	X	•	-	-	-
 Passat Saloon 2015 (2015 >)	X	•	X	•	-	-	-
 Polo 2017 (2017 >)	X	•	X	•	-	-	-
Polo 3 Door (2009 >)	X	•	X	•	-	-	-
Polo 5 Door (2009 >)	X	•	X	•	-	-	-
Scirocco (2011 >)	X	-	-	•	-	-	-
Sharan (2010 >)	X	•	•	•	X	-	X
 T-Cross (2019 >)	X	•	X	•	-	-	-
 T-Roc (2017 >)	X	•	X	•	-	-	-
Tiguan (2008 >)	X	•	X	•	-	-	-
 Tiguan 2016 (2016 >)	X	•	X	•	-	-	-
 Tiguan Allspace 2017 > (2017 >)	X	•	X	•	X	-	X
Touareg (2012 >)	X	•	X	•	-	-	-
Touareg (2003 - 2010)	X	X	X	X	-	-	-
 Touareg 2018 (2018 >)	X	•	X	•	-	-	-
Touran (2010 >)	X	X	X	X	X	-	X
 Touran 2016 (2016 >)	X	•	•	•	X	-	X
UP! (2015 >)	X	•	X	•	-	-	-



Allison Baby UK Ltd,
Venture Point, Towers Business Park
Rugeley, Staffordshire, WS15 1UZ

view all fine signature selections at
joiebaby.com/signature

IM-001003F