

# Joie™

0-18kg

## i-Pivot 360™

汽車用兒童保護裝置

### 使用說明書

本產品符合安全標準  
CNS 11497 測試和認證  
組裝及使用本產品前  
請先閱讀說明書全文



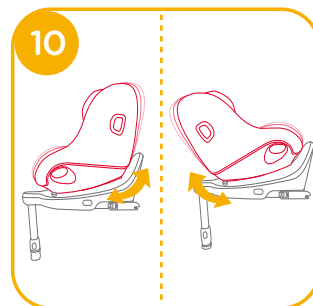
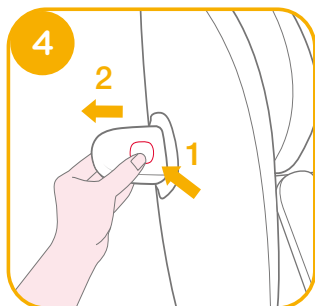
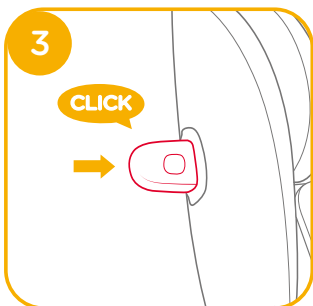
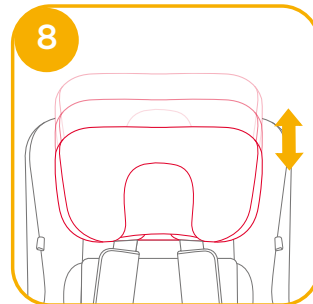
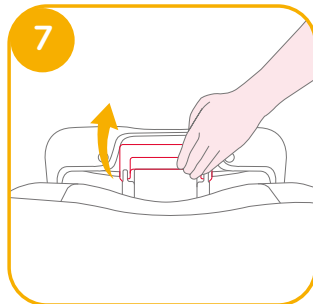
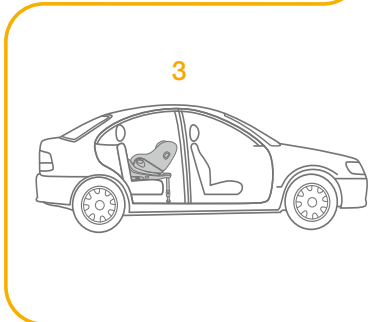
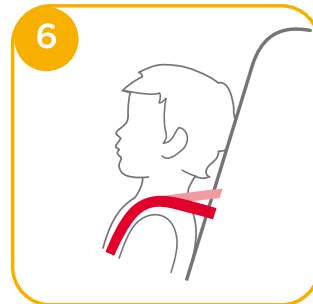
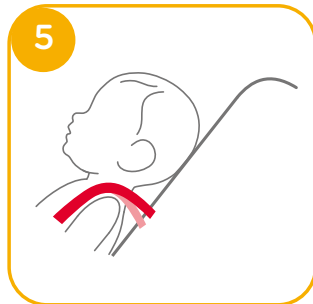
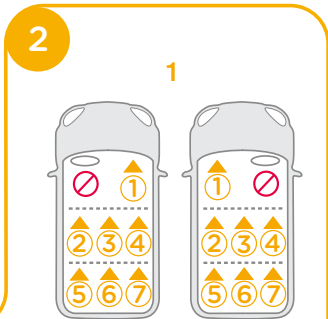
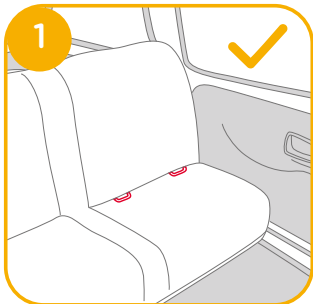

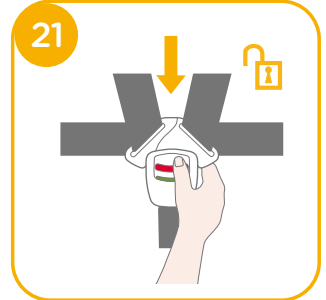
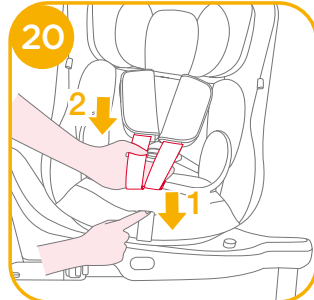
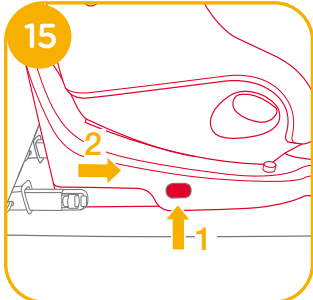
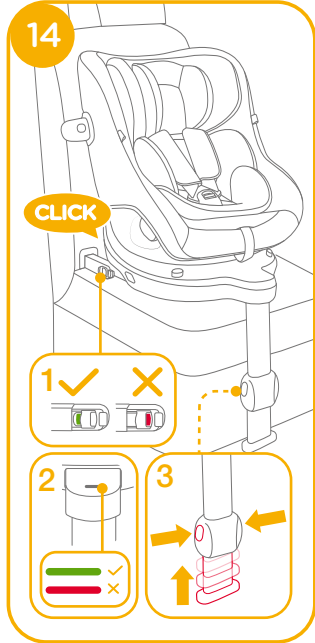
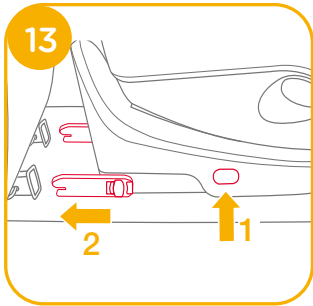
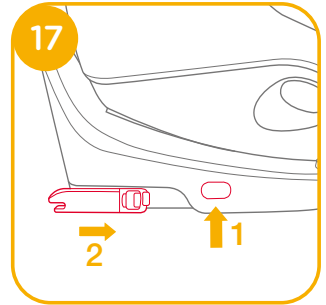
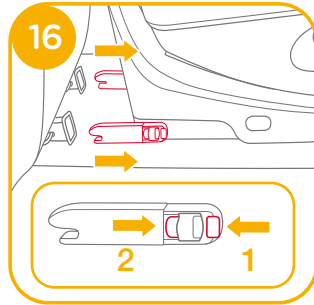
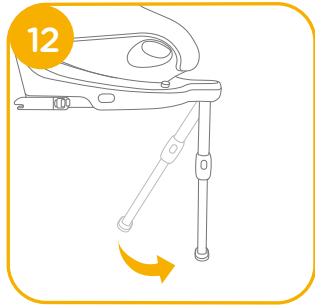
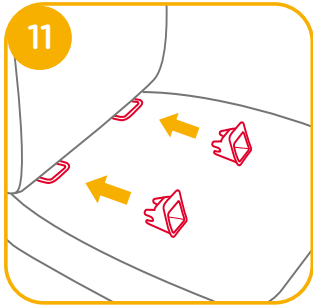

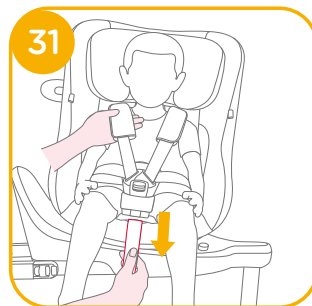
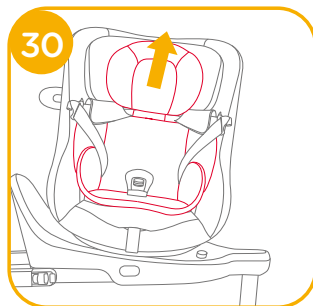
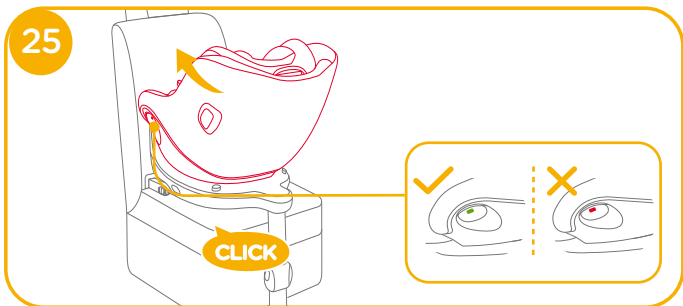
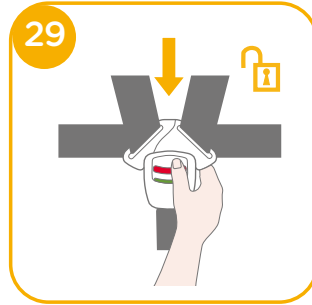
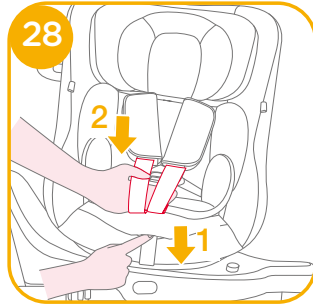
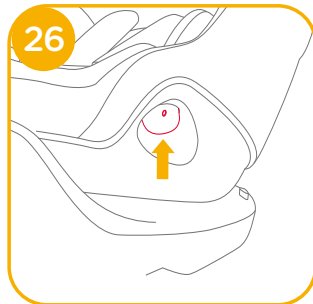
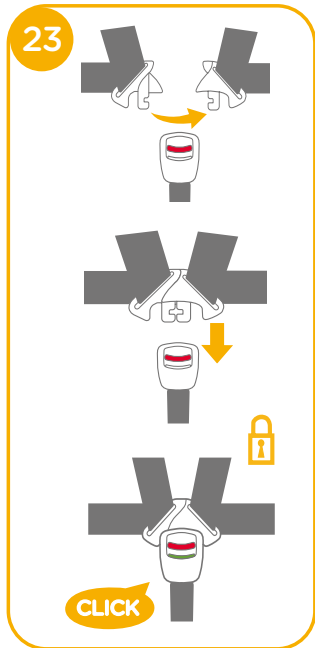

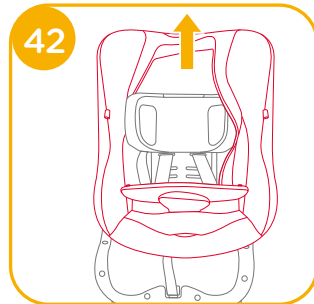
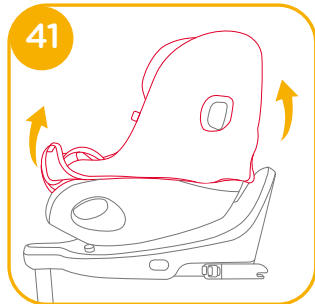
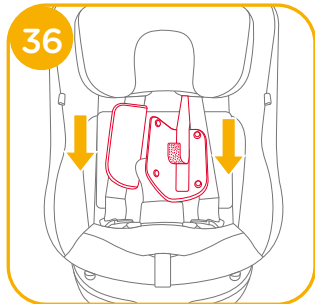
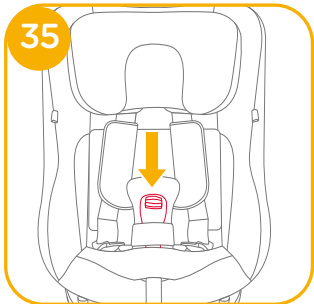
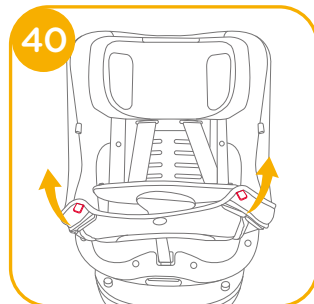
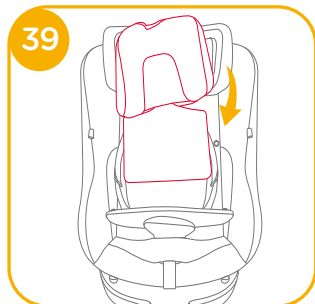
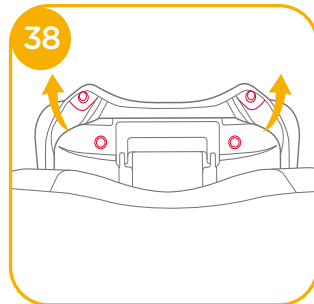
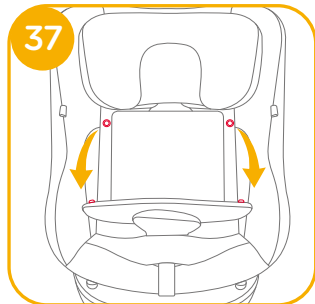
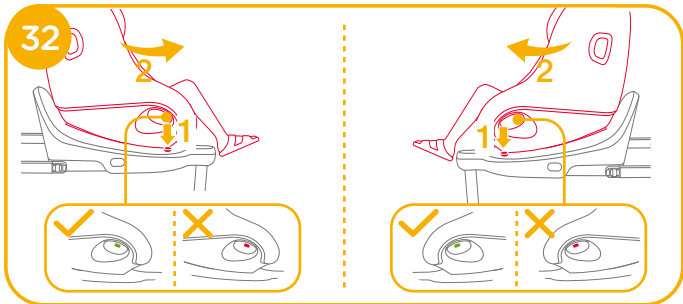

# 恭喜您

恭喜您成為 Joie 家族的一員！很高興能與您的寶寶共度行車旅程。乘坐本產品時，您的寶寶享受的是一台高品質和通過安全標準及歐盟安全標準檢測的 O+/I 級車用兒童保護裝置。請仔細研讀並依照本說明書的指示操作，如此才能保障並提供您的寶寶一個安全又舒適的行車旅程。

本車用兒童保護裝置適用於有 ISOFIX 固定裝置的汽車，因本車用兒童保護裝置是依安全標準 CNS 11497 去做測試和認證的。台灣區域使用請依照 CNS 標準規範。

這台車用兒童保護裝置適用於體重 18kg (約 4 歲) 以下的兒童。

## 車用兒童保護裝置

！重要：請仔細閱讀並妥善保存本說明書，以便日後參考。

本說明書不使用時，請存放在本體後方的存儲空間內(如下圖)。安裝和使用本產品前，請先閱讀說明書全文。

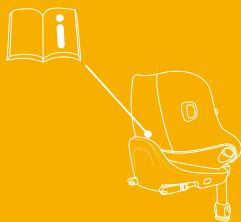

## 產品組件及各部件名稱

請確認產品組件是否有遺漏，如有遺漏，請聯繫代理商。本產品無需工具進行組裝。

- |             |                |
|-------------|----------------|
| 1 頭靠        | 10 小座墊         |
| 2 側翼        | 11 頭靠調整拉桿      |
| 3 安全扣       | 12 ISOFIX 調整按鈕 |
| 4 織帶調整按鈕    | 13 ISOFIX 連接器  |
| 5 調整織帶      | 14 支撐腳調整按鈕     |
| 6 座椅調整按鈕    | 15 ISOFIX 導向器  |
| 7 前向乘坐防誤用按鈕 | 16 側向保護塑膠      |
| 8 旋轉按鈕      |                |
| 9 肩帶護片      |                |

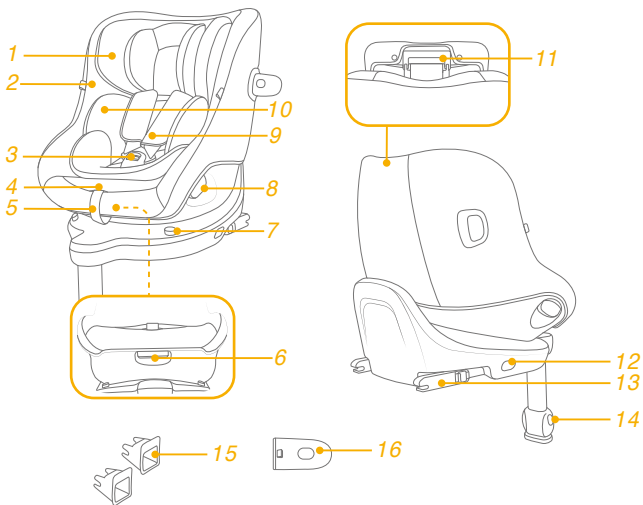

## 警告

- ! 必須小心定位和安裝兒童保護裝置，以免被活動式座椅或車門卡住。
- ! 兒童保護裝置適用於體重18kg (約4歲) 以下的兒童。
- ! 前向安裝勿提供2歲以下兒童乘坐，超過2歲兒童，仍宜儘量使用後向安裝。
- ! 後向使用時，嚴禁將本兒童保護裝置置於有正面空氣囊的座位上。
- ! 任何束縛兒童之織帶應根據兒童身體進行調節，且此織帶不應扭曲。
- ! 將寶寶放在本兒童保護裝置後，必須正確的扣合及使用安全帶，並確保腰部織帶能有效束縛骨盆部位。
- ! 本兒童保護裝置若於意外中遭受劇烈撞擊後，不可繼續使用，應立即更換兒童保護裝置。意外可能導致兒童保護裝置產生潛在危險。
- ! 請勿在兒童保護裝置上進行未經驗證許可之改裝或增加其他裝置以及未依兒童保護裝置製造商提供之安裝說明使用，以免造成受傷或死亡。
- ! 請讓座椅遠離日光，以免產品溫度過高對兒童的皮膚造成傷害。
- ! 在無人照料下，不得讓兒童留在兒童保護裝置內。
- ! 任何行李或其他可能在碰撞中造成傷害之物品應適當牢固。
- ! 當本兒童保護裝置沒有座布時，請勿使用，因座布為兒童保護裝置束縛性能之整體構要件。
- ! 請勿使用非本製造商推薦的座布，否則會影響兒童保護裝置的總體性能。
- ! 不要使用非說明書中所述以及兒童保護裝置中所標示的其他受力點。
- ! 請勿在未閱讀或了解本兒童保護裝置說明書及汽車說明書之前，使用或安裝本兒童保護裝置。因為可能會導致嚴重受傷或死亡的危險。

- ! 本兒童保護裝置如有任何損壞或零件缺失時，請勿繼續使用。
- ! 請勿讓您的寶寶穿着過大的衣物，所穿的衣物必須能讓兒童保護裝置的安全帶適當而安全地扣在寶寶兩腿之間。
- ! 請勿使用二手兒童保護裝置或來歷不明的兒童保護裝置，因為它們可能存在危害乘坐兒童安全的潛在危險。
- ! 不可使用繩子等其他物件代替汽車安全帶，以免兒童被意外勒住。
- ! 有關零件更換或維修問題，請向代理商諮詢。
- ! 請勿把本兒童保護裝置當作平常的椅子使用，會容易翻倒造成傷害。
- ! 使用本產品前，請取掉PE袋和包裝材料，並放到嬰兒和兒童觸摸不到的地方。
- ! 請勿搬運乘坐有兒童的兒童保護裝置。
- ! 長期不使用兒童保護裝置時，請將其搬離汽車座椅。
- ! 請勿將任何物品置於支撐腳附近。
- ! 兒童保護裝置不能安裝於前座之位置。
- ! 請時常查看ISOFIX導向器是否有髒汙，必要時請清洗導向器。髒汙、灰塵、食物殘渣等會影響產品安裝的穩定性。
- ! 以下汽車座椅不能安裝本兒童保護裝置：
  1. 不具備ISOFIX固定裝置的汽車座椅。
  2. 相對於汽車的行駛方向，橫向或後向的汽車座椅。
  3. 安裝不穩定的汽車座椅。

## 緊急情況處理

遇緊急事故時，需將安全帶剪斷，迅速將乘坐的兒童移離現場。

## 產品資訊

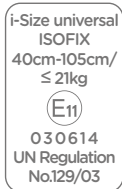

### ISOFIX連接器安裝兒童保護裝置

1. 此為ISOFIX兒童保護裝置，符合安全標準CNS 11497。用於裝有ISOFIX固定器系統之車輛座椅。
2. 本兒童保護裝置安裝適用於車輛配有經認可之ISOFIX安裝位置。(請參照車輛使用手冊)請依此兒童保護裝置之種類及ISOFIX尺度等級，安裝於附有ISOFIX固定器系統之車輛座椅上。
3. 此兒童保護裝置使用之質量等級ISOFIX尺度等級為：質量等級0+：D，質量等級I：B1，D。
4. 若有疑問，請洽兒童保護裝置製造商或參考車輛使用手冊。
5. 此兒童保護裝置被歸類為“半通用型”，符合安全標準CNS 11497。用於裝有ISOFIX固定器系統之車輛座椅。
6. 其他車輛型式亦有可能適用此兒童保護裝置。若有疑問，請洽兒童保護裝置製造商或代理商。

### Allison Baby UK Ltd.

Venture Point, Towers Business Park,  
Rugeley, Staffordshire, WS15 1UZ

[www.joiebaby.com](http://www.joiebaby.com)

|      |                           |
|------|---------------------------|
| 產品名稱 | 汽車用兒童保護裝置                 |
| 產品型號 | C2302                     |
| 適用範圍 | 18kg (約4歲) 以下的寶寶          |
| 主要材質 | 塑膠、五金、布                   |
| 質量等級 | 0+ / I                    |
| 淨重   | 11.43kg                   |
| 產品尺寸 | 416-653mmx627-742mmx517mm |
| 製造日期 | 詳見產品上貼紙日期(年/月/日)          |
| 專利號碼 | 專利申請中                     |
| 原產地  | 中國                        |

|      |                 |
|------|-----------------|
| 委製商  | 巧兒宜國際股份有限公司     |
| 進口商  | 巧兒宜國際股份有限公司     |
| 地址   | 台北市內湖區瑞光路431號2樓 |
| 電話   | 02-27973000     |
| 統一編號 | 52603333        |

|      |  |
|------|--|
| 代理商  | 奇哥股份有限公司 Chickabiddy Co., Ltd                          |
| 地址   | 台北市南京東路四段186號5樓  |
| 服務專線 | 0800-001-256/02-25781188                               |
| 統一編號 | 04222671   |
| 網址   | <a href="http://www.chick.com.tw">www.chick.com.tw</a> |



## 安裝模式選擇

| CNS<br>11497 | 寶寶體重   | 安裝模式  | 安裝圖示  | 參考年齡  | 背靠段位  |
|--------------|--------|---|---|-------|-------|
|              | 0-18kg | 後向模式  |  | 未滿4歲  | 第1-5段 |
| 9-18kg       | 前向模式   |  | 2-4歲  | 第1-5段 |       |

! 前向安裝勿提供2歲以下兒童乘坐，超過2歲兒童，仍宜儘量使用後向安裝。

## 安裝注意事項

見圖 ① - ②

## 使用側向保護塑膠

見圖 ③ - ④

1. 兒童保護裝置的側向保護塑膠必須安裝在最靠近汽車車門的一側。才能更好的保護兒童的安全 ③
2. 按壓釋鎖按鈕即可釋鎖側向保護塑膠 ④
3. 不使用時請保存好側向保護塑膠。

## 頭靠及肩帶高度調整

見圖 ⑤ - ⑧

1. 調整頭靠位置，並且檢查肩帶是否在適當位置 ⑤&⑥&⑦&⑧

! 使用後向模式時，肩帶高度需與寶寶的肩膀相同或略低於寶寶的肩膀 ⑤

! 使用前向模式時，肩帶高度需與寶寶的肩膀相同或略高於寶寶的肩膀 ⑥

按壓頭靠調整拉桿 ⑦，同時上下滑動頭靠到合適高度，頭靠高度共有6個段位，調整如⑧所示。

## 座椅背靠角度調整

見圖 9 - 10

按壓座椅背靠調整按鈕調整兒童保護裝置本體至適當位置 9 & 10

背靠角度調整有5個段位 10

## 安裝底座

見圖 11 - 17

1. 將ISOFIX導向器固定到ISOFIX 固定點上 11
2. 按壓底座的ISOFIX調整按鈕，拉出ISOFIX連接器 13 -1 & 13 -2
3. 請確定左右兩邊的ISOFIX連接器都已固定到ISOFIX固定點上且兩個ISOFIX連接器上的指示器應顯示綠色 14 -1
  - ! ISOFIX連接器已正確固定後，按壓底座的ISOFIX調整按鈕，將兒童保護裝置緊靠汽車座椅背靠。
4. ISOFIX連接器正確固定後，將支撐腳延伸到地面。支撐腳正確安裝時，支撐腳指示器顯示綠色，否則顯示紅色 14 -2
5. 按壓支撐腳調整按鈕可將支撐腳向上調整 14 -3
  - ! 無論是否有小孩乘坐，支撐腳都應該與地面完全接觸保持鎖定狀態。

## 移除底座

1. 按壓底座ISOFIX調整按鈕，將底座向外拉，按壓兩側ISOFIX連接器上的第二道安全鎖與釋鎖按鈕，然後將底座向外拉即可 16
2. 按壓底座ISOFIX調整按鈕 17 -1 收合ISOFIX連接器 17 -2

## 後向使用 (未滿18kg/0-4歲的寶寶)

參考年齡 新生兒-4歲

座椅段位 第1-5段

見圖 18 - 25

! 請先將兒童保護裝置安裝到汽車後座椅上，再讓寶寶乘坐。

按壓旋轉按鈕可以旋轉本體方便兒童從側面進出，然後將本體旋轉至後向位置 18 & 19

! 按壓任意一側的旋轉按鈕都可以旋轉兒童保護裝置本體。

## 寶寶乘坐

1. 按壓織帶調整按鈕，同時將肩帶拉出至適當長度 20
2. 按壓紅色按鈕，鬆開安全扣 21
3. 將安全扣打開，將扣具固定在本體兩側的鬆緊帶內方便放入寶寶 22

## 使用小座墊

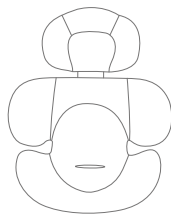

小座墊可以提供完整的側撞保護功能。  
適用于0-6個月的寶寶，也可以依照寶寶的體型調整使用方式。

- 將寶寶放入兒童保護裝置內，再將寶寶兩臂穿過安全帶。
- 扣好安全扣 <sup>23</sup>
- 下拉調整織帶，調整肩帶至適當長度，以配合寶寶身形 <sup>24</sup>
  - ！要始終保持兒童用安全帶固定，並拉緊。
  - ！確保寶寶與肩帶之間須可以放進一個手掌的厚度。
  - ！當座椅被旋轉到位並正確卡合，旋轉按鈕顯示綠色，否則顯示紅色 <sup>25</sup>
  - ！無論是否有小孩乘坐，本體應始終保持前向或後向鎖定狀態。

## 前向使用 (9-18kg/2-4歲的寶寶)

參考年齡 2-4歲

座椅段位 第1-5段

見圖 <sup>26</sup> - <sup>33</sup>

- ！請先將兒童保護裝置安裝到汽車後座椅上，再讓寶寶乘坐。
- 按壓旋轉按鈕可以旋轉本體方便兒童從側面進出，然後將本體旋轉至前向位置 <sup>26</sup> & <sup>27</sup>
- ！按壓任意一側的旋轉按鈕都可以旋轉兒童保護裝置本體。

## 寶寶乘坐

- 按壓織帶調整按鈕，同時將肩帶拉出至適當長度 <sup>26</sup>
- 按壓紅色按鈕，鬆開安全扣 <sup>29</sup>
  - ！前向模式時請移除小座墊 <sup>30</sup>
- 將安全扣打開，將扣具固定在本體兩側的鬆緊帶內方便放入寶寶。
- 將寶寶放入兒童保護裝置內，再將寶寶兩臂穿過安全帶。
- 扣好安全扣。

- 下拉調整織帶，調整肩帶至適當長度，以配合寶寶身形 <sup>31</sup>
- 將本體旋轉至前向位置時請按前向乘坐防誤用按鈕 <sup>32</sup>
  - ！當座椅被旋轉到位並正確卡合，旋轉按鈕顯示綠色，否則顯示紅色 <sup>32</sup>
  - ！無論是否有小孩乘坐，本體應始終保持前向或後向鎖定狀態。
  - ！ISOFIX連接器須鎖定在ISOFIX固定點上 <sup>33</sup> -1
  - ！底座支撐腳須正確固定，並以綠色顯示 <sup>33</sup> -2
  - ！要始終保持兒童用安全帶固定，並拉緊。
  - ！重要-前向安裝勿提供2歲以下兒童乘坐。

## 座布拆卸

見圖 <sup>34</sup> - <sup>42</sup>

- 按壓紅色按鈕，鬆開安全扣 <sup>34</sup>
- 參考 <sup>35</sup> - <sup>42</sup> 步驟即可拆卸座布。反向操作即可組裝座布。

## 保養維護與保固

- ! 小座墊拆除後，請將其存放於寶寶無法接觸到的地方。
- ! 請使用30度以下水溫清洗。
- ! 請勿使用熨斗熨燙。
- ! 請勿使用漂白劑及乾洗。
- ! 請勿使用未經稀釋的中性清潔劑、汽油或其他有機溶劑清洗本兒童保護裝置，否則可能對兒童保護裝置造成損壞。
- ! 請勿大力扭乾，過大力扭乾可能留下皺褶。
- ! 請於陰涼處鋪平晾乾。
- ! 當長時間不使用本兒童保護裝置時，請將本兒童保護裝置從汽車座椅上拆除，並存放於陰涼處及寶寶不易接觸的地方。



### 延長保固服務

請於購買起一個月內至奇哥官網進行登錄，登錄成功後即享有商品延長一年保固服務。

## 汽車安裝資訊

1. 此兒童保護裝置被歸類為“半通用型”，符合安全標準CNS 11497。適合安裝在下列汽車座椅位置。下圖中的數字與“汽車安裝資訊”內的數字相對應。
2. 其他車輛型式亦有可能適用此兒童保護裝置。若有疑問，請洽兒童保護裝置製造商或代理商。
3. 兒童保護裝置不能安裝於前座之位置。
4. 後向使用時，嚴禁將本兒童保護裝置置於有正面空氣囊的座位上。
5. ● 表示汽車座椅可安裝本兒童保護裝置。
6. ✘ 表示汽車座椅不可安裝本兒童保護裝置。
7.  表示符合i-size的車輛。
8. 如果您的汽車品牌未被列入本說明書或未用“●”或“✘”進行標示，請查閱您的汽車手冊或聯絡兒童保護裝置製造商，以進一步了解相關資訊。
9. **SB!** 表示汽車地板下有儲存盒。這種情況下請聯繫汽車製造商去瞭解進一步的細節，因為即使座椅位置可能在該列表中獲得批准也無法提供正確的底座安裝。
10. 此汽車資訊信息是收集車輛及汽車座椅後仔細編制的。對於明細的準確性不承擔任何責任，目的僅用於指導。建議您在購買時檢查您所購買的兒童保護裝置與您的汽車是否匹配。

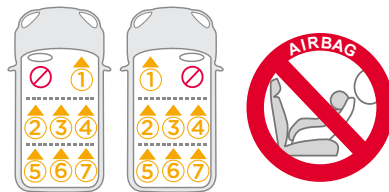

Joie™

0-18kg

## i-Pivot 360™

enhanced child restraint

### Instruction Manual

This child restraint is approved to CNS 11497 series of amendments. Please read all the instructions in this manual before installing and using the product.



# GB Welcome to Joie™

You have purchased a high quality, fully certified child safety child restraint.

Carefully read this Instruction Manual and follow the installing steps because this is the **ONLY** way to protect your child from serious injury or death in case of an accident, and to provide comfort to your child while using this product.

Keep this instruction manual for future reference.

## Please confirm

To use this Joie enhanced child restraint with the i-Size ISOFIX connections according to CNS 11497, your child must meet the following requirements.

Rear Facing: Child age infant - 4Y / Child weight 0 - 18 kg;

Forward Facing: Child age 2 - 4Y / Child weight 9 - 18 kg;

Please read all the instructions in this manual before installing and using the product.

**! IMPORTANT: KEEP FOR FUTURE REFERENCE.**

**PLEASE READ CAREFULLY.**

Please keep the instruction manual in the storage compartment at the back of the seat as right figure.

For warranty information, please visit our website at [joiebaby.com](http://joiebaby.com)

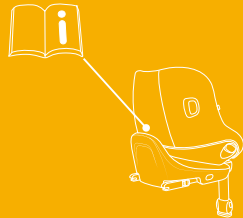

## Parts List

Please make sure there are no missing parts. Please contact the retailer if anything is missing.

- |                             |  |
|-----------------------------|--|
| 1 Head Support              | 10 Insert                                  |
| 2 Seat Pad                  | 11 Head Support Adjustment Lever           |
| 3 Buckle                    | 12 ISOFIX Adjuster Button                  |
| 4 Harness Adjustment Button | 13 ISOFIX Connector                        |
| 5 Adjustment Webbing        | 14 Load Leg Adjustment Button              |
| 6 Recline Adjustment Button | 15 ISOFIX Attachments Guides               |
| 7 Swivel Lock-off           | 16 Side Impact Protection                  |
| 8 Rotation Button           | <small>*must use on door side only</small> |
| 9 Shoulder Harness Covers   |  |

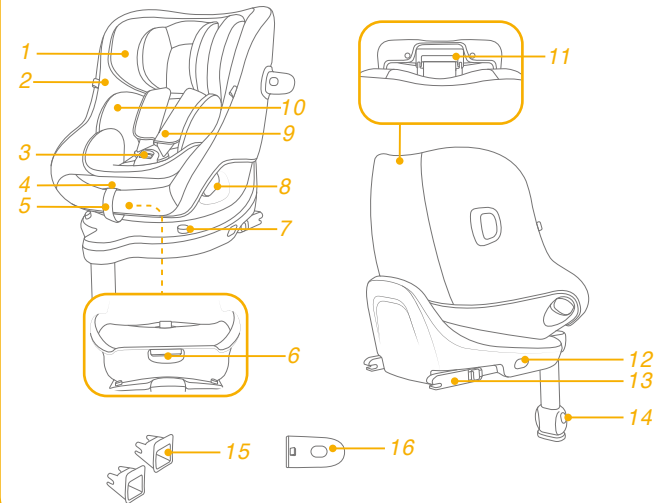

## WARNING

- ! BE informed that the rigid items and plastic parts of an enhanced child restraint system shall be located and installed so that they are not liable to become trapped by a movable seat or in a door of the vehicle during everyday use of the vehicle.
- ! DO NOT use the rearward facing enhanced child restraint systems in seating positions where there is an active frontal airbag installed.
- ! Your child must meet the following requirements.
- ! Rear Facing Mode: Child age infant - 4Y / Child weight 0 - 18 kg;  
Forward Facing Mode: Child age 2 - 4Y / Child weight 9 - 18 kg;
- ! **IMPORTANT - DO NOT USE FORWARD FACING BEFORE THE CHILD'S AGE EXCEEDS 2 YEARS** (Refer to instructions).
- ! The enhanced child restraint may not fit in all approved vehicles due to storage compartments or limited space to the vehicle roof. In doubt, please contact your retailer or reach out to us.
- ! Any support-leg should be in contact with the vehicle floor, any straps restraining the child should be adjusted to the child's body, and straps should not be twisted.

## WARNING

- ! After your child is placed in this enhanced child restraint, the safety belt must be used correctly. Ensure that any lap strap is worn low down, so that the pelvis is firmly engaged, shall be stressed.
- ! This enhanced child restraint should be replaced when it has been subject to violent stresses in an accident. An accident can cause damage to it that you cannot see.
- ! Consider the danger of making any alterations or additions to the device without approval of the adequate authority, and the danger of not following closely to the installation instructions provided by the enhanced child restraint manufacturer.
- ! Please keep this enhanced child restraint away from sunlight, otherwise it may be too hot for child's skin. Always touch the enhanced child restraint before placing child in it.
- ! DO NOT leave your child unattended in the enhanced child restraint system.
- ! Any luggage or other objects liable to cause injuries in the event of a collision shall be properly secured.
- ! The enhanced child restraint system shall NOT BE USED without the soft goods.
- ! The soft goods should not be replaced with any other than the one recommended by the manufacturer, because the soft goods constitutes an integral part of the restraint performance.

## WARNING

- ! Please check if this enhanced child restraint can be installed properly in your vehicle before you purchase it.
- ! NO enhanced child restraint can guarantee full protection from injury in an accident. However, proper use of this enhanced child restraint will reduce the risk of serious injury or death to your child.
- ! DO NOT install this enhanced child restraint without following the instructions in this manual or you may put your child at serious risk of injury or death.
- ! DO NOT use this enhanced child restraint if it has damaged or missing parts.
- ! DO NOT have your child in large/oversized clothes because this may prevent your child from being properly and securely fastened by the shoulder harness straps and the crotch strap between the legs.

## Emergency

In case of emergency or accidents, it is most important to have your child taken care of with first aid and medical treatment immediately.

## Product Information



1. This is an i-Size Enhanced Child Restraint System. It is approved according to UN Regulation No.129, for use in, i-Size compatible vehicle seating positions as indicated by vehicle manufacturers in the vehicle users' manual.
2. If in doubt, consult either the Enhanced Child Restraint System manufacturer or the retailer.

**Materials**           Plastics, metal, fabrics

**Patent No.**           Patents pending



## Choose Your Installation

|           | Child's Size | Installation Mode | Figure for Installation   | Reference Age      | Seat Position |
|-----------|--------------|-------------------|---|--------------------|---------------|
| CNS 11497 | 0-18kg       | Rear Facing       |  | infant to 4 years  | Position 1-5  |
|           | 9-18kg       | Forward Facing    |  | 2 years to 4 years | Position 1-5  |

## Concerns on Installation

see images ① - ②

## Use Side Impact Protection

see images ③ - ④

1. The enhanced child restraint is delivered with removable side impact protection pod. Insert the side impact pod on the side closest to the door. Installation shown in ③.
2. Press the release button to remove side impact protection. ④

## Height Adjustment for Head Support and Shoulder Harnesses

see images ⑤ - ⑧

Please adjust the head support and check if the shoulder harnesses are at the correct height according to ⑤&⑥&⑦&⑧

! When used in rear facing mode, the shoulder harness height must be even with or just below the top of child's shoulders. ⑤

! When used in forward facing mode, the shoulder harness height must be even with or just above the top of child's shoulders. ⑥

Press the head support adjustment lever ⑦ and pull up or push down the head support until it clicks into one of the 6 positions, shown as ⑧.

## Recline Adjustment

see images 9 - 10

Press the recline adjustment button to adjust the enhanced child restraint to the desired position. 9&10.

There are 5 recline positions that can be used for both rear facing mode and forward facing mode. 10

## Base Installation

see images 11 - 17

1. Insert ISOFIX guides to assist with installation. 11
2. Press the ISOFIX adjuster button to extend the ISOFIX. 13 -1&13 -2
3. Make sure that both ISOFIX connectors are securely attached to their ISOFIX anchor points. The colors of the indicators on both ISOFIX connectors should be completely green. 14 -1

! Press the ISOFIX adjustment buttons again while pushing the seat back until it comes in contact with the vehicle seat backrest.

4. After attaching the ISOFIX, pull the load leg downward to floor. When the load leg indicator shows green, the load leg is installed correctly. 14 -2

5. Squeeze the load leg releasing button, then adjust the load leg length. 14 -3

! Always make sure the support leg has direct contact with the floor and is in locked position even when the child is not in it.

## Removing the seat

1. To remove from the vehicle press the ISOFIX adjuster button and pull the base back from the seat. Then press and release the connectors from the vehicle's ISOFIX. 16
2. To prevent damage during transit, press the ISOFIX adjuster button 17 -1 and fold the connector completely. 17 -2

## Using in the rear facing mode (infant - 4 years old/Child weight 0 - 18kg)

see images 18 - 25

! Install the enhanced child restraint on the rear vehicle seat, and then place the child in the enhanced child restraint.

Press the rotating button to rotate for easier side loading/unloading of the child, then rotate the seat to the rear facing position. 18&19

! Press the rotating button on either side to rotate the enhanced child restraint.

## Securing Child

1. To lengthen the shoulder harness belts, press the harness adjustment button while pulling out the shoulder harnesses to loosen. 20
2. Unbuckle the harness by pressing the red button. 21
3. Fix the buckles on the both sides of the seat shown as 22 which located on the both sides of seat to make placing the child in rear facing mode more convenient.

## Use Infant Insert

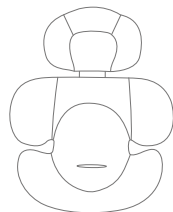

We recommend using the full infant insert while the baby is 0-6 months and can be used until they outgrow the infant insert. The infant insert increases side impact protection.

4. Place the child into the enhanced child restraint and pass both arms through the harnesses.
  5. Engage the buckle. Please refer to 23
  6. Pull down the adjustment webbing and adjust it to the proper length to make sure your child is properly secured. 24
- ! Always keep child secured in harness and properly tightened by removing any slack.
  - ! Make sure the space between the child and the shoulder harness straps is about the thickness of one hand.
  - ! When the seat is rotated in place and properly engaged, rotation button will show green; otherwise it will show red. 25
  - ! Always make sure the seat is in locked position (rearward facing / forward facing) even when the child is not in it.

## Using in the forward facing mode (2 years - 4 years old/Child weight 9 - 18kg)

see images 26 - 33

- ! Install the enhanced child restraint on the rear vehicle seat, and then place the child in the enhanced child restraint.
- Press the rotation button to rotate for easier side loading/unloading of the child, then rotate the seat to the forward facing position. 26&27
- ! Press the rotation button on either side to rotate the enhanced child restraint.

### Securing Child

1. To lengthen the shoulder harness belts, press the harness adjustment button while pulling out the shoulder harnesses to loosen. 28
  2. Unlock the buckle of the harnesses by pressing the red button. 29
- ! Remove the infant insert when in forward facing mode. 30

3. Fix the buckles on the both sides of the seat which located on the both sides of seat to make placing the child in forward facing mode more convenient.
  4. Place the child into the enhanced child restraint and pass both arms through the harnesses.
  5. Engage the buckle.
  6. Pull down the adjustment webbing and adjust it to the proper length to make sure your child is properly secured. 31
  7. Press the swivel lock off button while you rotate the seat to the forward facing mode. 32
- ! When the seat is rotated in place and properly engaged, rotation button will show green, otherwise it will show red. 32
  - ! Always make sure the seat is in locked position (rearward facing / forward facing) even when the child is not in it.
  - ! The ISOFIX connectors must be attached and locked onto the ISOFIX anchor points. 33-1
  - ! The load leg must be installed correctly with green indicator. 33 -2
  - ! Always keep child secured in harness and properly tightened by removing any slack.
  - ! DO NOT use forward facing mode until your child's height is at least 2 years old.

## Detach Soft Goods

see images 34 - 42

- Press the red button to disengage the buckle. 34
- Follow steps 35 - 42 to detach soft goods.
- To re-attach the soft goods please repeat the above steps in the reverse order.

## Care and Maintenance

- ! Please store the pad somewhere out of the child's reach.
- ! Please wash the soft goods with cold water under 30°C.
- ! Do not iron the soft goods.
- ! Do not bleach or dry clean the soft goods.
- ! Do not use undiluted detergents gasoline or other organic solvent to wash the enhanced child restraint or base. It may cause damage to the enhanced child restraint.
- ! Do not twist the soft goods to dry with great force. It may leave the soft goods with wrinkles.
- ! Please hang dry the soft goods in the shade.
- ! Please remove the enhanced child restraint from the vehicle seat if it will not be in use for a long period of time.



## Vehicle Fitting Information

1. Seat positions in other cars may also be suitable to accept the child restraint.
2. The numbers on the diagram below correspond with the vehicle fitting positions listed in the following pages.
3. ALWAYS give priority to the rear seats of your vehicle.
4. DO NOT use the rearward facing enhanced child restraint systems in seating positions where there is an active frontal airbag installed.
5. If your child restraint can be fitted, it is marked with •
6. If your child restraint cannot be fitted, it is marked with ✘
7. i-Size vehicles are marked with 
8. If your vehicle is not listed in this manual or it is not marked with either a • or ✘ then please refer to your vehicle's handbook or contact the manufacturer for further information.
9. Vehicles equipped with a storage box in floor compartment are marked with **SB!**. In this case please contact the vehicle manufacturer for further details as proper base installation may not be given even though seat position might be approved in this list.
10. This fitting-list was carefully prepared using scientific data collected from both vehicle and car seat. No liability is accepted for the accuracy of the list, which is for guidance purposes only. You are advised to check that the seat purchase is compatible with your car at the time of purchase.

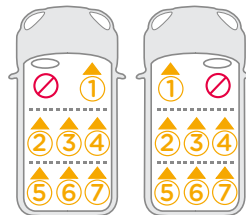

## 40-105cms RF with SIP

① ② ③ ④ ⑤ ⑥ ⑦







### Alfa Romeo

|   |                    |   |   |   |   |   |   |   |   |
|---|--------------------|---|---|---|---|---|---|---|---|
|  | 4C Coupe (2014 >)  | X | - | - | - | - | - | - | - |
|   | Giulia (2017 >)    | X | • | X | • | - | - | - | - |
|   | Guilietta (2010 >) | X | X | X | X | - | - | - | - |
|   | MiTo 3dr (2009 >)  | X | X | - | X | - | - | - | - |
|  | Stelvio (2017 >)   | X | • | X | • | - | - | - | - |





### Aston Martin

|                  |   |   |   |   |   |   |   |   |   |
|------------------|---|---|---|---|---|---|---|---|---|
| DB11 (2019 >)    | X | X | - | X | - | - | - | - | - |
| DBS (2019 >)     | X | X | - | X | - | - | - | - | - |
| Vantage (2019 >) | X | - | - | - | - | - | - | - | - |



### Audi

|  |                               |   |   |   |   |   |   |   |   |
|--|-------------------------------|---|---|---|---|---|---|---|---|
|   | A1 2018 5dr (2018 >)          | X | • | X | • | - | - | - | - |
|  | A1 Sportback 5dr (2012 >)     | X | X | X | X | - | - | - | - |
|  | A3 2004 5dr (2005 - 2011)     | X | • | X | • | - | - | - | - |
|  | A3 3dr (1996 - 2003)          | X | X | X | X | - | - | - | - |
|  | A3 Hatch 5dr (2012 >)         | X | • | X | • | - | - | - | - |
|  | A3 S3 5dr (2012 >)            | X | • | X | • | - | - | - | - |
|  | A3 Saloon (2014 >)            | X | • | X | • | - | - | - | - |
|  | A3 e-Tron Sportback (2015 >)  | X | • | X | • | - | - | - | - |
|  | A4 2005 (2005 - 2008)         | X | • | X | • | - | - | - | - |
|   | A4 2015 (2015 >)              | X | • | X | • | - | - | - | - |
|  | A4 Avant (2008 >)             | X | • | X | • | - | - | - | - |
|  | A5 Sportback (2009 >)         | X | • | X | • | - | - | - | - |
|   | A5/S5 Cabriolet 2017 (2017 >) | X | X | - | X | - | - | - | - |
|   | A5/S5 Coupe 2016 (2016 >)     | X | X | - | X | - | - | - | - |
|  | A5/S5 Sportback 2017 (2017 >) | X | • | X | • | - | - | - | - |
|  | A6 Allroad (2011 >)           | X | • | X | • | - | - | - | - |
|  | A6 Avant (2011 >)             | X | • | X | • | - | - | - | - |
|  | A7 Sportback (2011 >)         | X | • | X | • | - | - | - | - |
|  | A7/S7 Sportback (2016 >)      | X | • | X | • | - | - | - | - |
|  | A7/S7 Sportback 2018 (2018 >) | X | • | X | • | - | - | - | - |
|  | A8 (2011 >)                   | X | • | X | • | - | - | - | - |
|  | A8 S8 (2011 >)                | X | • | X | • | - | - | - | - |
|   | A8/S8 2018 (2018 >)           | X | • | X | • | - | - | - | - |
|  | Q2 (2016 >)                   | X | • | X | • | - | - | - | - |
|  | Q3 (2011 >)                   | X | • | X | • | - | - | - | - |

① ② ③ ④ ⑤ ⑥ ⑦

|   |                      |   |   |   |   |   |   |   |   |
|---|----------------------|---|---|---|---|---|---|---|---|
|  | Q3 (2019 >)          | X | • | X | • | - | - | - | - |
|   | Q4 e-Tron (2021 >)   | X | • | X | • | - | - | - | - |
|   | Q5 (2009 >)          | X | X | X | X | - | - | - | - |
|   | Q5/SQ5 2017 (2017 >) | X | • | X | • | - | - | - | - |
|   | Q7 (2006 >)          | X | X | X | X | - | - | - | - |
|  | Q7 2015 (2015 >)     | X | • | X | • | X | - | X | - |
|  | Q8 (2018 >)          | X | • | X | • | - | - | - | - |
|   | TT Coupe (2008 >)    | X | X | - | X | - | - | - | - |







### BMW

|   |                        |   |   |   |   |   |   |   |   |
|---|------------------------|---|---|---|---|---|---|---|---|
| 1 Series (f20) 5dr (2011 >)   | X                      | • | X | • | - | - | - | - | - |
| 1-Series 5dr (2004 - 2010)  | X                      | • | X | • | - | - | - | - | - |
| 1-Series Cabrio (2008 >)  | X                      | • | - | - | - | - | - | - | - |
| 1-Series Coupe (2008 >)   | X                      | • | - | - | - | - | - | - | - |
| 2-Series AC-T (2015 >)  | X                      | • | X | • | - | - | - | - | - |
| 2-Series Coupe (2014 >)   | X                      | • | - | - | - | - | - | - | - |
| 3 Series (f30) (2012 >)   | X                      | • | X | • | - | - | - | - | - |
| 3-Series (E46) Coupe (2002 - 2006)  | X                      | X | X | X | - | - | - | - | - |
| 3-Series Coupe (E90) (2007 >)   | X                      | • | - | - | - | - | - | - | - |
| 3GT (2013 >)  | X                      | • | X | • | - | - | - | - | - |
| 4-Series Gran Coupe (2014 >)  | X                      | X | X | X | - | - | - | - | - |
| 5-GT (2010 >)   | X                      | • | X | • | - | - | - | - | - |
| 5-Series (F10) (2011 >)   | X                      | • | X | • | - | - | - | - | - |
| 5-Series (E60) (2003 - 2010)  | X                      | • | X | • | - | - | - | - | - |
|  | 5-Series 2018 (2018 >) | X | • | X | • | - | - | - | - |
| 6-Series Cabrio (2011 >)  | X                      | X | - | X | - | - | - | - | - |
| 6-Series Coupe (2Dr) (2011 >)   | X                      | X | - | X | - | - | - | - | - |
| 6-Series Gran Coupe (4Dr) (2011 >)  | X                      | • | X | • | - | - | - | - | - |
| 7-Series (2010 >)   | X                      | • | X | • | - | - | - | - | - |
| 7-Series 2015 (2015 >)  | X                      | • | X | • | - | - | - | - | - |
| X1 (2009 - 2015)  | X                      | • | X | • | - | - | - | - | - |
|  | X1 2016 (2016 >)       | X | • | X | • | - | - | - | - |
| X3 (F25) (2011 >)   | X                      | • | X | • | - | - | - | - | - |
|  | X3 2018 (2018 >)       | X | • | X | • | - | - | - | - |
| X4 (2014 >)   | X                      | • | X | • | - | - | - | - | - |
| X5 2000 (2000 - 2006)   | X                      | X | X | X | - | - | - | - | - |
| X5 2007 (2007 - 2014)   | X                      | X | X | X | - | - | X | - | X |
| X5 2015 (2015 >)  | X                      | • | X | • | X | - | X | - | X |
| X6 (2009 >)   | X                      | • | X | • | - | - | - | - | - |
| X6 2015 (2015 >)  | X                      | • | - | - | - | - | - | - | - |

① ② ③ ④ ⑤ ⑥ ⑦

|                  | ①   | ② | ③ | ④ | ⑤ | ⑥ | ⑦ |
|------------------|---|---|---|---|---|---|---|
|                  | i3 (2014 >)   | X | . | . | . | . | . |
|                  |  i8 (2014 >)     | X | X | X | . | . | . |
|                  | iX (2021 >)   | X | X | X | . | . | . |
|                  |  iX3 (2022 >)    | X | X | X | . | . | . |
| <b>Bentley</b>   |   |   |   |   |   |   |   |
|                  | Continental Flying Spur (2005 >)  | X | X | X | . | . | . |
|                  | Continental GT (2003 - 2012)  | X | X | X | . | . | . |
|                  | Continental GT Conv (2006 - 2012)   | X | X | X | . | . | . |
|                  | Mulsanne (2012 >)   | X | X | X | . | . | . |
| <b>Cadillac</b>  |   |   |   |   |   |   |   |
|                  | BLS (2005 - 2012)   | X | X | X | . | . | . |
| <b>Chevrolet</b> |   |   |   |   |   |   |   |
|                  | Aveo 5dr (2012 >)   | X | X | X | . | . | . |
|                  | Captiva (2010 >)  | X | X | X | . | . | . |
|                  | Cruze (2011 >)  | X | X | X | . | . | . |
|                  | Orland (2011 >)   | X | X | X | . | . | . |
|                  | Spark 5dr (2012 >)  | X | X | X | . | . | . |
|                  | Traxx (2013 >)  | X | X | X | . | . | . |
|                  | Volt (2011 >)   | X | . | . | . | . | . |
| <b>Chrysler</b>  |   |   |   |   |   |   |   |
|                  | 300C (2012 >)   | X | X | X | . | . | . |
|                  | Delta (2007 >)  | X | X | X | . | . | . |
|                  | Grand Voyager (2008 >)  | X | . | . | X | X | X |
|                  | Ypsilon 3dr (2012 >)  | X | X | X | X | . | . |
| <b>Citroen</b>   |   |   |   |   |   |   |   |
|                  | <b>SB!</b> Berlingo II (2008 >)   | X | X | X | . | . | . |
|                  | <b>SB!</b> Berlingo Multispace (2007 >)   | X | X | X | X | X | X |
|                  |  C-Cactus (2015) | X | X | X | . | . | . |
|                  | C1 2015 5dr (2015 >)  | X | X | X | . | . | . |
|                  | C1 3dr (2006 >)   | X | X | X | . | . | . |
|                  | C3 5Dr (2009 >)   | X | X | X | . | . | . |

① ② ③ ④ ⑤ ⑥ ⑦

|              | ①  | ② | ③ | ④ | ⑤ | ⑥ | ⑦ |
|--------------|--|---|---|---|---|---|---|
|              | C3 5dr 2005 (2005 - 2009)  | X | . | X | . | . | . |
|              |  C3 5dr 2016 (2016 >)   | X | . | X | . | . | . |
|              | C3 Aircross (2017 >)   | X | . | X | . | . | . |
|              | <b>SB!</b> C3 Picasso (2009 >)   | X | X | X | . | . | . |
|              | <b>SB!</b> C4 G-Picasso 2007 (2007 - 2013)   | X | X | X | X | X | X |
|              | <b>SB!</b> C4 G-Picasso (2014 >)   | X | X | X | X | X | X |
|              | <b>SB!</b> C4 Picasso (2007 - 2013)  | X | X | X | X | X | X |
|              | C5 (2008 >)  | X | X | X | X | . | . |
|              |  C5 2005 (2005 - 2008)  | X | X | X | X | . | . |
|              | C5 Aircross (2019 >)   | X | X | X | X | . | . |
|              | C5 Tourer (2009 >)   | X | X | X | X | . | . |
|              | DS3 (2011 >)   | X | X | X | X | . | . |
|              | DS3 Cabrio (2013 >)  | X | . | X | . | . | . |
|              |  DS3 Crossback (2019 >) | X | . | X | . | . | . |
|              | DS4 (2011 >)   | X | . | X | . | . | . |
|              | DS5 (2013 >)   | X | . | X | . | . | . |
|              |  DS7 (2018 >)           | X | . | X | . | . | . |
|              | Jumpy (2007 - 2016)  | X | . | X | . | X | X |
|              | Nemo (2008 >)  | X | . | X | . | . | . |
|              | Xsara 5dr (2000 - 2004)  | X | X | X | X | . | . |
|              | <b>SB!</b> Xsara Picasso (2000 - 2012)   | X | X | X | X | . | . |
| <b>Dacia</b> |  |   |   |   |   |   |   |
|              |  Duster (2012 >)        | X | . | X | . | . | . |
|              | Jogger (2022 >)  | X | X | X | X | . | . |
|              | Logan MCV (2013 >)   | X | X | X | X | . | . |
|              | Logan MCV 2006 (2008/11-2013/7)  | X | X | X | X | . | . |
|              | Sandero (2013 >)   | X | X | X | X | . | . |
| <b>FIAT</b>  |  |   |   |   |   |   |   |
|              | 124 Spider 2016 (2016 >)   | X | . | . | . | . | . |
|              | 500 (2008 >)   | X | X | . | X | . | . |
|              | 500L (2013 >)  | X | . | X | . | . | . |
|              |  500X (2015 >)          | X | X | X | . | . | . |
|              | Bravo (2007 >)   | X | . | X | . | . | . |
|              | Doblo (2007 >)   | X | . | X | . | . | . |
|              | Panda (2012 >)   | X | X | X | X | . | . |
|              | Punto 3dr (Grande Punto) (2006 >)  | X | X | X | X | . | . |
|              | Qubo (2008 >)  | X | . | X | . | . | . |

Ford

|  |                                   |   |   |   |   |   |   |   |   |
|--|-----------------------------------|---|---|---|---|---|---|---|---|
|  | Tipo 2016 (2016 >)                | X | . | X | . | . | . | . | . |
|  | Galaxy 2016 (2016 >)              | X | X | X | X | X | . | . | X |
|  | B-Max (2012 >)                    | X | . | X | . | . | . | . | . |
|  | C-Max 2013 (2011 >)               | X | X | X | X | . | . | . | . |
|  | <b>SB!</b> C-Max (2003 - 2013)    | X | X | X | X | . | . | . | . |
|  | EcoSport (2015 >)                 | X | . | X | . | . | . | . | . |
|  | <b>SB!</b> Edge (2016 >)          | X | . | X | . | X | . | X | . |
|  | Fiesta 2004 3dr (2004 - 2008)     | X | X | X | X | . | . | . | . |
|  | Fiesta 2008 5dr (2008 >)          | X | . | X | . | . | . | . | . |
|  | Fiesta 2017 > (2017 >)            | X | . | X | . | . | . | . | . |
|  | Focus (2010 >)                    | X | . | X | . | . | . | . | . |
|  | Focus 2005 (2005 - 2009)          | X | X | X | X | . | . | . | . |
|  | Focus 2018 (2018 >)               | X | . | X | . | . | . | . | . |
|  | Focus EV (2015 >)                 | X | . | X | . | . | . | . | . |
|  | Focus Mk1 (1998 - 2004)           | X | X | X | X | . | . | . | . |
|  | Galaxy (2006 >)                   | X | X | X | X | X | . | X | . |
|  | Ka 3dr (2009 - 2013)              | X | X | . | X | . | . | . | . |
|  | Ka+ 2016 5dr (2016 >)             | X | . | X | . | . | . | . | . |
|  | Kuga 2008 (2008 - 2012)           | X | X | X | X | . | . | . | . |
|  | Kuga 2013 (2013 >)                | X | . | X | . | . | . | . | . |
|  | Kuga 2017 (2017 >)                | X | . | X | . | . | . | . | . |
|  | Kuga 2020 (2020 >)                | X | . | X | . | . | . | . | . |
|  | Mondeo 2000 (2000 - 2007)         | X | X | X | X | . | . | . | . |
|  | Mondeo Estate (2007 >)            | X | . | X | . | . | . | . | . |
|  | Mustang Cabrio 2015 (2015 >)      | X | X | . | X | . | . | . | . |
|  | Mustang Coupe 2015 (2015 >)       | X | X | . | X | . | . | . | . |
|  | Mustang Mach E (2022 >)           | X | . | X | . | . | . | . | . |
|  | New Mondeo 2014 (2014 >)          | X | . | X | . | . | . | . | . |
|  | Puma (2020 >)                     | X | . | X | . | . | . | . | . |
|  | Ranger Double-Cab Pickup (2019 >) | X | . | X | . | . | . | . | . |
|  | S-Max (2006 >)                    | X | X | X | X | X | . | X | . |
|  | S-Max 2015 (2015 >)               | X | X | X | X | X | . | X | . |

Genesis

|  |  |                   |   |   |   |   |   |   |   |
|--|--|-------------------|---|---|---|---|---|---|---|
|  |  | G80 (2021 >)      | X | . | X | . | . | . | . |
|  |  | GV80 SUV (2021 >) | X | . | X | . | . | . | . |

Honda

|  |  |                             |   |   |   |   |   |   |   |
|--|--|-----------------------------|---|---|---|---|---|---|---|
|  |  | Accord Saloon (2008 >)      | X | . | X | . | . | . | . |
|  |  | CR-V (2007 - 2012)          | X | X | X | X | . | . | . |
|  |  | CR-V 2012 (2012 >)          | X | . | X | . | . | . | . |
|  |  | CR-V 2019 (2019 >)          | X | . | X | . | X | . | X |
|  |  | Civic (2012 >)              | X | . | X | . | . | . | . |
|  |  | Civic (2006 - 2011)         | X | . | X | . | . | . | . |
|  |  | Civic 2017 (2017 >)         | X | . | X | . | . | . | . |
|  |  | Civic Saloon 2019 (2019 >)  | X | . | X | . | . | . | . |
|  |  | Civic Tourer (2014 >)       | X | . | X | . | . | . | . |
|  |  | E (2021 >)                  | X | . | X | . | . | . | . |
|  |  | Elysion (2012 >)            | X | . | . | . | X | X | X |
|  |  | FRV (2006 - 2011)           | X | X | X | X | . | . | . |
|  |  | HR-V (2015 >)               | X | . | X | . | . | . | . |
|  |  | HR-V 2022 (2022 >)          | X | . | X | . | . | . | . |
|  |  | Insight (2009 >)            | X | X | X | X | . | . | . |
|  |  | Jazz (2008 - 2015)          | X | . | X | . | . | . | . |
|  |  | Jazz 2002 (2002 - 2008)     | X | X | X | X | . | . | . |
|  |  | Jazz 2016 (2016 >)          | X | . | X | . | . | . | . |
|  |  | Jazz 2020 (2020 >)          | X | . | X | . | . | . | . |
|  |  | Jazz Crosstar 2021 (2021 >) | X | . | X | . | . | . | . |
|  |  | Odyssey (2010 >)            | X | X | . | X | . | . | . |

Hyundai

|  |                 |                             |   |   |   |   |   |   |   |
|--|-----------------|-----------------------------|---|---|---|---|---|---|---|
|  |                 | Genesis Sedan (2016 >)      | X | . | X | . | . | . | . |
|  |                 | Getz 5dr (2005 - 2011)      | X | X | X | . | . | . | . |
|  |                 | Ioniq Hybrid (2016 >)       | X | . | X | . | . | . | . |
|  |                 | Ix20 (2011 >)               | X | . | X | . | . | . | . |
|  |                 | Kona 2017 > (2017 >)        | X | X | X | X | . | . | . |
|  |                 | Santa Fe (2012 >)           | X | . | X | . | X | . | X |
|  | <b>Santa Fe</b> | Santa Fe 2007 (2007 - 2012) | X | . | X | . | X | . | X |
|  |                 | Tucson 2015 (2015 >)        | X | . | X | . | . | . | . |
|  |                 | Veloster (2012 >)           | X | X | X | X | . | . | . |
|  |                 | i10 2014 5dr (2014 >)       | X | X | X | X | . | . | . |
|  |                 | i10 5dr (2008 >)            | X | X | X | X | . | . | . |
|  |                 | i20 2014 > (2014 >)         | X | . | X | . | . | . | . |
|  |                 | i20 2015 (2015 >)           | X | . | X | . | . | . | . |
|  |                 | i20 Hatch (2009 >)          | X | X | X | X | . | . | . |
|  |                 | i30 Hatch (2012 >)          | X | . | X | . | . | . | . |





① ② ③ ④ ⑤ ⑥ ⑦

|   |                              |   |   |   |   |   |   |   |
|---|------------------------------|---|---|---|---|---|---|---|
|   | i30 Hatch 2015 (2015 - 2017) | X | • | X | • | - | - | - |
|  | i30 Hatch 2017 (2017 >)      | X | • | X | • | - | - | - |
|   | i40 (2011 >)                 | X | • | X | • | - | - | - |
|   | i800/H1 (2008 >)             | X | • | X | • | X | X | X |
|   | ix35 (2010 >)                | X | • | X | • | - | - | - |

Infiniti

|  |                   |   |   |   |   |   |   |   |
|--|-------------------|---|---|---|---|---|---|---|
|  | EX SUV (2009 >)   | X | • | X | • | - | - | - |
|  | FX SUV (2009 >)   | X | • | X | • | - | - | - |
|  | G Coupe (2009 >)  | X | X | - | X | - | - | - |
|  | G Saloon (2009 >) | X | • | X | • | - | - | - |
|  | M Saloon (2010 >) | X | • | X | • | - | - | - |

Jaguar

|   |                         |   |   |   |   |   |   |   |
|---|-------------------------|---|---|---|---|---|---|---|
|   | E-Pace (2018 >)         | X | • | X | • | - | - | - |
|  | F-Pace (2016 >)         | X | • | X | • | - | - | - |
|   | F-Type Coupe (2014 >)   | X | - | - | - | - | - | - |
|  | I-Pace (2018 >)         | X | • | X | • | - | - | - |
|   | X-Type (2001 - 2010)    | X | X | X | X | - | - | - |
|   | XE (2015 >)             | X | • | X | • | - | - | - |
|  | XF (2008 >)             | X | • | X | • | - | - | - |
|  | XF 2015 (2015 >)        | X | • | X | • | - | - | - |
|  | XF Estate 2015 (2015 >) | X | • | X | • | - | - | - |
|   | XF Sportbrake (2012 >)  | X | • | X | • | - | - | - |
|   | XJ (2010 >)             | X | • | X | • | - | - | - |
|   | XK Coupe (2006 >)       | X | X | - | X | - | - | - |













Jeep

|   |                         |   |   |   |   |   |   |   |
|---|-------------------------|---|---|---|---|---|---|---|
|   | Cherokee 2014 (2014 >)  | X | • | X | • | - | - | - |
|   | Compass (2011 >)        | X | • | X | • | - | - | - |
|  | Grand Cherokee (2011 >) | X | • | X | • | - | - | - |
|   | Renegade 2015 (2015 >)  | X | • | X | • | - | - | - |
|   | Wrangler 5Dr (2007 >)   | X | X | X | X | - | - | - |

Kia

|   |                    |   |   |   |   |   |   |   |
|---|--------------------|---|---|---|---|---|---|---|
|   | Ceed 2020 (2020 >) | X | • | X | • | - | - | - |
|  | EV6 (2022 >)       | X | • | X | • | - | - | - |

① ② ③ ④ ⑤ ⑥ ⑦

|   |                                 |   |   |   |   |   |   |   |
|---|---------------------------------|---|---|---|---|---|---|---|
|   | Sorento 2015 (2015 >)           | X | • | X | • | X | - | X |
|  | Sorento 2020 (2020 >)           | X | • | X | • | X | - | X |
|   | Soul EV (2015 >)                | X | • | X | • | - | - | - |
|  | Soul EV 2019 (2019 >)           | X | • | X | • | - | - | - |
|  | XCeed (2020 >)                  | X | • | X | • | - | - | - |
|   | <b>SBI</b> Carens 2013 (2013 >) | X | X | X | X | X | - | X |
|   | Cee'D Hatch (2012 >)            | X | • | X | • | - | - | - |
|   | Cee'D Hatch (2012 >)            | X | • | X | • | - | - | - |
|  | Niro 2017 (2017 >)              | X | • | X | • | - | - | - |
|  | Niro Hybrid 2022 (2022 >)       | X | • | X | • | - | - | - |
|   | Optima (2011 >)                 | X | • | X | • | - | - | - |
|  | Optima 2016 (2016 >)            | X | • | X | • | - | - | - |
|  | Picanto 2012 5dr (2011 - 2015)  | X | • | X | • | - | - | - |
|  | Picanto 2017 > (2017 >)         | X | X | X | X | - | - | - |
|   | Picanto 5dr (2008 >)            | X | X | X | X | - | - | - |
|   | Rio (2012 >)                    | X | • | X | • | - | - | - |
|  | Rio 2017 > (2017 >)             | X | • | X | • | - | - | - |
|   | Sorento (2012 >)                | X | • | X | • | - | - | - |
|   | Sorento (2003 - 2009)           | X | • | X | • | - | - | - |
|   | Soul (2009 >)                   | X | • | X | • | - | - | - |
|   | Sportage (2011 >)               | X | • | X | • | - | - | - |
|  | Sportage 2016 (2016 >)          | X | • | X | • | - | - | - |
|  | Sportage 2022 (2022 >)          | X | • | X | • | - | - | - |
|  | Stonic 2017 > (2017 >)          | X | • | X | • | - | - | - |
|   | Venga (2011 >)                  | X | • | X | • | - | - | - |

Lancia

|  |                      |   |   |   |   |   |   |   |
|--|----------------------|---|---|---|---|---|---|---|
|  | Thema (2012 >)       | X | • | X | • | - | - | - |
|  | Voyager (2010 >)     | X | • | - | - | X | X | X |
|  | Ypsilon 3dr (2012 >) | X | X | X | X | - | - | - |

Land Rover

|   |                           |   |   |   |   |   |   |   |
|---|---------------------------|---|---|---|---|---|---|---|
|  | Defender 2020 (2020 >)    | X | • | X | • | X | - | X |
|   | Discovery 4 (2009 >)      | X | X | X | X | - | - | - |
|  | Discovery 5 2017 (2017 >) | X | • | X | • | X | - | X |
|   | Discovery Sport (2015 >)  | X | • | X | • | X | - | X |
|   | Freelander 2 (2006 >)     | X | • | X | • | - | - | - |
|   | Range Rover (2002 - 2012) | X | • | X | • | - | - | - |
|   | Range Rover 2013 (2013 >) | X | • | X | • | - | - | - |



① ② ③ ④ ⑤ ⑥ ⑦

|  |  |   |   |   |   |   |   |   |   |
|--|--|---|---|---|---|---|---|---|---|
|  | Range Rover Evoque (2011 >)            | X | X | X | X | - | - | - | - |
|  | Range Rover Evoque (5dr) 2019 (2019 >) | X | - | X | - | - | - | - | - |
|  | Range Rover Evoque 5 door (2011 >)     | X | - | X | - | - | - | - | - |
|  | Range Rover Sport (2005 - 2012)        | X | - | X | - | - | - | - | - |
|  | Range Rover Sport (2013 >)             | X | - | X | - | - | - | - | - |
|  | Range Rover VELAR (2017 >)             | X | - | X | - | - | - | - | - |

**Lexus**

|  |                        |   |   |   |   |   |   |   |   |
|--|------------------------|---|---|---|---|---|---|---|---|
|  | CT (2011 >)            | X | - | X | - | - | - | - | - |
|  | ES Hybrid (2019 >)     | X | - | X | - | - | - | - | - |
|  | GS (2013 >)            | X | - | X | - | - | - | - | - |
|  | IS (2005 >)            | X | - | X | - | - | - | - | - |
|  | IS 200 (2004) (1999 >) | X | - | X | - | - | - | - | - |
|  | NX (2014 >)            | X | - | X | - | - | - | - | - |
|  | RX (2010 >)            | X | - | X | - | - | - | - | - |
|  | RX 2016 (2017 >)       | X | - | X | - | - | - | - | - |
|  | UX (2019 >)            | X | - | X | - | - | - | - | - |

**MG**

|  |                      |   |   |   |   |   |   |   |   |
|--|----------------------|---|---|---|---|---|---|---|---|
|  | 5 EV Estate (2020 >) | X | - | X | - | - | - | - | - |
|  | GS (2016 >)          | X | - | X | - | - | - | - | - |
|  | HS PHEV SUV (2021 >) | X | - | X | - | - | - | - | - |
|  | HS SUV (2021 >)      | X | - | X | - | - | - | - | - |
|  | Motor MG6 (2012 >)   | X | - | X | - | - | - | - | - |
|  | ZS (2021 >)          | X | - | X | - | - | - | - | - |
|  | ZS EV (2021 >)       | X | - | X | - | - | - | - | - |

**MINI**

|  |                             |   |   |   |   |   |   |   |   |
|--|-----------------------------|---|---|---|---|---|---|---|---|
|  | Countryman (2010 >)         | X | - | X | - | - | - | - | - |
|  | Coupe (2009 >)              | X | - | - | - | - | - | - | - |
|  | Hatch (2006 >)              | X | X | - | X | - | - | - | - |
|  | Hatchback 3Dr 2014 (2014 >) | X | X | - | X | - | - | - | - |
|  | Hatchback 3dr (2000 - 2006) | X | X | - | X | - | - | - | - |
|  | Hatchback 5dr 2015 (2015 >) | X | - | X | - | - | - | - | - |
|  | Paceman (2013 >)            | X | X | - | X | - | - | - | - |

① ② ③ ④ ⑤ ⑥ ⑦

**Maserati**

|  |                            |   |   |   |   |   |   |   |   |
|--|----------------------------|---|---|---|---|---|---|---|---|
|  | Ghibli 2014 (2014 >)       | X | - | X | - | - | - | - | - |
|  | Gran Turismo 2007 (2007 >) | X | X | - | X | - | - | - | - |
|  | Levante (2017 >)           | X | - | X | - | - | - | - | - |
|  | Quattroporte 2016 (2016 >) | X | - | X | - | - | - | - | - |

**Mazda**

|  |                           |   |   |   |   |   |   |   |   |
|--|---------------------------|---|---|---|---|---|---|---|---|
|  | 2 (2007 >)                | X | - | X | - | - | - | - | - |
|  | 2 2015 5dr (2015 >)       | X | - | X | - | - | - | - | - |
|  | 3 Hatch (2009 - 2013)     | X | - | X | - | - | - | - | - |
|  | 3 Hatchback 2014 (2014 >) | X | - | X | - | - | - | - | - |
|  | 5 (2005 - 2010)           | X | - | X | - | - | - | - | - |
|  | 6 (2007 - 2012)           | X | - | X | - | - | - | - | - |
|  | 6 2018 (2018 >)           | X | - | X | - | - | - | - | - |
|  | 6 Estate (2013 >)         | X | - | X | - | - | - | - | - |
|  | 6 Saloon (2013 >)         | X | - | X | - | - | - | - | - |
|  | CX-3 (2015 >)             | X | - | X | - | - | - | - | - |
|  | CX-5 (2011 >)             | X | - | X | - | - | - | - | - |
|  | CX-7 (2007 >)             | X | - | X | - | - | - | - | - |
|  | MX-5 2015 (2016 >)        | X | - | - | - | - | - | - | - |

**Mercedes-Benz**

|  |                                 |   |   |   |   |   |   |   |   |
|--|---------------------------------|---|---|---|---|---|---|---|---|
|  | A Class (2005 - 2012)           | X | X | X | X | - | - | - | - |
|  | A-Class (2013 >)                | X | - | X | - | - | - | - | - |
|  | A-Class Hatchback 2019 (2019 >) | X | - | X | - | - | - | - | - |
|  | A-Class Saloon 2019 (2020 >)    | X | - | X | - | - | - | - | - |
|  | B-Class (2012 >)                | X | X | X | X | - | - | - | - |
|  | B-Class EV (2015 >)             | X | X | X | X | - | - | - | - |
|  | C-Class 2015 Estate (2015 >)    | X | X | X | X | - | - | - | - |
|  | C-Class Coupe (2011 >)          | X | X | - | X | - | - | - | - |
|  | C-Class Estate (2008 >)         | X | - | X | - | - | - | - | - |
|  | CLA (2013 >)                    | X | - | X | - | - | - | - | - |
|  | CLA 2019 (2020 >)               | X | - | X | - | - | - | - | - |
|  | CLA Shooting-Brake (2015 >)     | X | - | X | - | - | - | - | - |
|  | CLS Coupe (2011 >)              | X | - | X | - | - | - | - | - |
|  | CLS Shooting Brake (2012 >)     | X | - | X | - | - | - | - | - |
|  | E-Class 2006 (2006 - 2009)      | X | - | X | - | - | - | - | - |
|  | E-Class Cabriolet 2017 (2017 >) | X | - | - | - | - | - | - | - |

① ② ③ ④ ⑤ ⑥ ⑦

|  |                              |   |   |   |   |   |   |   |   |
|--|------------------------------|---|---|---|---|---|---|---|---|
|  | E-Class Coupe (2009 >)       | X | X | - | X | - | - | - | - |
|  | E-Class Coupe 2017 (2017 >)  | X | . | . | . | . | - | - | - |
|  | E-Class Estate (2013 >)      | X | . | X | . | . | - | - | - |
|  | E-Class Estate 2016 (2016 >) | X | . | X | . | . | - | - | - |
|  | E-Class Saloon 2013 (2013 >) | X | . | X | . | . | - | - | - |
|  | EQA 2021 (2021 >)            | X | . | X | . | . | - | - | - |
|  | EQC (2021 >)                 | X | . | X | . | . | - | - | - |
|  | GL Class (2012 >)            | X | . | X | . | X | - | X | - |
|  | GLA 2021 (2021 >)            | X | . | X | . | . | - | - | - |
|  | GLC (2016 >)                 | X | . | X | . | . | - | - | - |
|  | GLC Coupe (2019 >)           | X | . | X | . | . | - | - | - |
|  | GLE (2015 >)                 | X | . | X | . | . | - | - | - |
|  | GLE 2020 (2020 >)            | X | . | X | . | X | - | X | - |
|  | R-Class (2006 - 2012)        | X | X | X | X | - | - | - | - |
|  | S Class 2015 (2014 >)        | X | . | X | . | . | - | - | - |
|  | S-Class (2006 - 2013)        | X | . | X | . | . | - | - | - |
|  | SL-Class (2012 >)            | X | - | - | - | - | - | - | - |
|  | SLK (2012 >)                 | X | - | - | - | - | - | - | - |
|  | V-Class (2015 >)             | X | . | X | . | X | X | X | X |

Mini

|  |                          |   |   |   |   |   |   |   |   |
|--|--------------------------|---|---|---|---|---|---|---|---|
|  | Clubman 2016 (2016 >)    | X | X | X | X | - | - | - | - |
|  | Countryman 2017 (2017 >) | X | X | X | X | - | - | - | - |

Mitsubishi

|  |                                  |   |   |   |   |   |   |   |   |
|--|----------------------------------|---|---|---|---|---|---|---|---|
|  | ASX (2010 >)                     | X | . | X | . | . | - | - | - |
|  | Colt (2007 - 2013)               | X | X | X | X | - | - | - | - |
|  | Eclipse Cross (2019 >)           | X | . | X | . | . | - | - | - |
|  | Lancer (2008 - 2011 >)           | X | . | . | . | . | - | - | - |
|  | Lancer Sportback (2008 - 2011 >) | X | . | . | . | . | - | - | - |
|  | Mirage (2012 >)                  | X | X | X | X | - | - | - | - |
|  | Outlander (2007 - 2013)          | X | . | X | . | . | - | - | - |
|  | Outlander (2013 >)               | X | . | X | . | . | - | - | - |
|  | Outlander PHEV (2015 >)          | X | . | X | . | . | - | - | - |
|  | Shogun (2007 >)                  | X | . | X | . | . | - | - | - |

Nissan

|  |                       |   |   |   |   |   |   |   |   |
|--|-----------------------|---|---|---|---|---|---|---|---|
|  | 2008 X-Trail (2008 >) | X | . | X | . | . | - | - | - |
|--|-----------------------|---|---|---|---|---|---|---|---|

① ② ③ ④ ⑤ ⑥ ⑦

|  |                           |   |   |   |   |   |   |   |   |
|--|---------------------------|---|---|---|---|---|---|---|---|
|  | Juke (2010 >)             | X | X | X | X | - | - | - | - |
|  | Leaf EV (2010 - 2017)     | X | . | X | . | . | - | - | - |
|  | Micra 2017 > (2017 >)     | X | . | X | . | . | - | - | - |
|  | Micra 5dr (2011 >)        | X | X | X | X | - | - | - | - |
|  | Murano 2016 (2016 >)      | X | . | X | . | . | - | - | - |
|  | Navara 2015 > (2015 >)    | X | X | X | X | - | - | - | - |
|  | Note (2006 - 2013)        | X | X | X | X | - | - | - | - |
|  | Note 2014 (2014 >)        | X | . | X | . | . | - | - | - |
|  | Pulsar 2015 (2015 >)      | X | . | X | . | . | - | - | - |
|  | Qashqai 2007 (2006 -2013) | X | . | X | . | . | - | - | - |
|  | Qashqai 2014 (2014 >)     | X | . | X | . | . | - | - | - |
|  | Qashqai+2 (2008 >)        | X | . | X | . | . | - | - | - |
|  | Quest MPV (2012 >)        | X | . | . | . | X | X | X | X |
|  | X-Trail 2015 (2015 >)     | X | . | X | . | X | - | X | - |







Opel

|  |                              |   |   |   |   |   |   |   |   |
|--|------------------------------|---|---|---|---|---|---|---|---|
|  | Adam (2013 >)                | X | X | - | X | - | - | - | - |
|  | Agila (2008 >)               | X | . | X | . | . | - | - | - |
|  | Ampera (2011 >)              | X | . | . | . | . | - | - | - |
|  | Antara (2007 >)              | X | . | X | . | . | - | - | - |
|  | Astra 2003 5dr (2003 - 2009) | X | . | X | . | . | - | - | - |
|  | Astra 2010 5dr (2010 >)      | X | X | X | X | - | - | - | - |
|  | Astra 2015 (2015 >)          | X | . | X | . | . | - | - | - |
|  | Astra GTC (2011 >)           | X | . | X | . | . | - | - | - |
|  | Corsa 5dr 2015 (2015 >)      | X | . | X | . | . | - | - | - |
|  | Corsa Hatch 5dr (2006 >)     | X | . | X | . | . | - | - | - |
|  | Insignia Hatch (2009 >)      | X | . | X | . | . | - | - | - |
|  | Karl (2015 >)                | X | X | X | X | - | - | - | - |
|  | Meriva (2010 >)              | X | X | X | X | - | - | - | - |
|  | Mokka (2013 >)               | X | . | X | . | . | - | - | - |
|  | Vectra 2005 (2002 - 2008)    | X | . | X | . | . | - | - | - |
|  | Zafira (2005 >)              | X | X | X | X | - | - | - | - |
|  | Zafira Tourer (2012 >)       | X | X | X | X | X | - | X | - |

Peugeot

|  |                       |   |   |   |   |   |   |   |   |
|--|-----------------------|---|---|---|---|---|---|---|---|
|  | 107 3dr (2005 - 2013) | X | X | - | X | - | - | - | - |
|  | 108 5dr (2015 >)      | X | X | - | X | - | - | - | - |
|  | 2008 (2013 >)         | X | . | X | . | . | - | - | - |
|  | 2008 2020 (2020 >)    | X | . | X | . | . | - | - | - |

① ② ③ ④ ⑤ ⑥ ⑦

|   |   |   |   |   |   |   |   |
|---|---|---|---|---|---|---|---|
| 206 3dr (1998 - 2009)   | X | • | X | • | - | - | - |
| 207 3dr Hatchback (2006 - 2012)   | X | X | X | X | - | - | - |
| 207 5dr (2012 >)  | X | X | X | X | - | - | - |
|  208 2020 5dr (2020 >)         | X | • | X | • | - | - | - |
| 208 5dr (2012 >)  | X | • | X | • | - | - | - |
|  208 EV 2020 5dr (2020 >)      | X | • | X | • | - | - | - |
|  3008 2017 (2017 >)            | X | • | X | • | - | - | - |
| <b>SB!</b> 3008 (2009 >)  | X | • | X | • | - | - | - |
| 307 Hatchback (2001 - 2007)   | X | X | X | X | - | - | - |
| 308 (2014) (2014 >)   | X | • | X | • | - | - | - |
| 308 Hatchback (2007 >)  | X | X | X | X | - | - | - |
| 407 (2004 - 2011)   | X | • | X | • | - | - | - |
| <b>SB!</b> 5008 (2011 >)  | X | X | • | X | X | - | X |
|  <b>SB!</b> 5008 (2018 >)      | X | X | • | X | X | - | X |
| 508 (2011 >)  | X | X | X | X | - | - | - |
|  508 2019 (2018 >)             | X | • | X | • | - | - | - |
|  508 Estate PHEV 2019 (2019 >) | X | • | X | • | - | - | - |
| Bipper Tepee (2008 >)   | X | • | X | • | - | - | - |
| Expert Tepee (2008 >)   | X | • | X | • | X | - | X |
| Partner Combi (2004 - 2010)   | X | X | X | X | - | - | - |
| <b>SB!</b> Partner Tepee (2008 >)   | X | • | X | • | - | - | - |
| RCZ (2011 >)  | X | X | - | X | - | - | - |
| Traveller 2016 (2016 >)   | X | • | • | • | • | • | • |

Polestar

|  |   |   |   |   |   |   |   |
|--|---|---|---|---|---|---|---|
|  2 (2021 >) | X | • | X | • | - | - | - |
|--|---|---|---|---|---|---|---|



Porsche

|  |   |   |   |   |   |   |   |
|--|---|---|---|---|---|---|---|
|  Cayenne (2011 >) | X | • | X | • | - | - | - |
| Cayenne 2017 (2017 >)  | X | • | X | • | - | - | - |
| Cayenne E-Hybrid (2015 >)  | X | • | X | • | - | - | - |
| Macan (2014 >)   | X | • | X | • | - | - | - |
| Panamera (2011 >)  | X | • | • | - | - | - | - |
| Panamera E-Hybrid (2015 >)   | X | • | • | - | - | - | - |

Renault

|                        |   |   |   |   |   |   |   |
|------------------------|---|---|---|---|---|---|---|
| Captur (2015 >)        | X | • | X | • | - | - | - |
| Clio 5dr (2005 - 2013) | X | • | X | • | - | - | - |

① ② ③ ④ ⑤ ⑥ ⑦

|   |   |   |   |   |   |   |   |
|---|---|---|---|---|---|---|---|
| Clio 5dr 2013 (2013 >)  | X | X | X | X | - | - | - |
| Espace (2003 - 2012)  | X | X | • | X | X | - | X |
| Grand Espace (2003 - 2012)  | X | X | • | X | X | - | X |
| Kadjar (2015 >)   | X | • | X | • | - | - | - |
|  Koleos 2018 (2018 >)            | X | • | X | • | - | - | - |
| Laguna Sport Tourer (2008 - 2012)   | X | • | X | • | - | - | - |
|  Megane Hatch 2016 (2016 >)      | X | • | X | • | - | - | - |
| <b>SB!</b> Megane Hatch (2008 >)  | X | • | X | • | - | - | - |
| <b>SB!</b> Megane Hatch (2002 - 2009)   | X | • | X | • | - | - | - |
| Modus (2004 - 2012)   | X | • | X | • | - | - | - |
| <b>SB!</b> Scenic 2003 (2003 - 2009)  | X | X | X | X | - | - | - |
|  <b>SB!</b> Scenic 2017 (2017 >) | X | X | • | X | - | - | - |
| <b>SB!</b> Scenic (2009 >)  | X | X | X | X | - | - | - |
| Twingo 2015 (2015 >)  | X | X | - | X | - | - | - |
| Twingo 3dr (2007 >)   | X | X | - | X | - | - | - |





Rover

|                               |   |   |   |   |   |   |   |
|-------------------------------|---|---|---|---|---|---|---|
| 25 / Streetwise (1999 - 2005) | X | X | - | X | - | - | - |
|-------------------------------|---|---|---|---|---|---|---|













SAAB

|                              |   |   |   |   |   |   |   |
|------------------------------|---|---|---|---|---|---|---|
| 93 Sport Wagon (2005 - 2012) | X | • | X | • | - | - | - |
| New 95 (2011 - 2012)         | X | • | X | • | - | - | - |

SEAT

|  |   |   |   |   |   |   |   |
|--|---|---|---|---|---|---|---|
| <b>SB!</b> Alhambra (2010 >)   | X | X | • | X | X | - | X |
| Altea (2004 - 2012)  | X | • | X | • | - | - | - |
|  Arona (2021 >)         | X | • | X | • | - | - | - |
| Arosa (1997 - 2004)  | X | X | - | X | - | - | - |
|  Ateca 2018 (2018 >)    | X | X | X | X | - | - | - |
|  Cupra Born EV (2022 >) | X | • | X | • | - | - | - |
| Exeo ST (2008 >)   | X | • | X | • | - | - | - |
|  Ibiza 2018 (2018 >)    | X | • | X | • | - | - | - |
| Ibiza HATCH 5 door (2008 - 2013)   | X | X | X | X | - | - | - |
| Leon FR (2006 - 2012)  | X | • | X | • | - | - | - |
| Leon (2000 - 2005)   | X | X | X | X | - | - | - |
| New Toledo (2013 >)  | X | X | X | X | - | - | - |
| mii 5dr (2011 >)   | X | X | X | X | - | - | - |
| Leon 2013 (2013 >)   | X | • | X | • | - | - | - |

Skoda

|   |                              |   |   |   |   |   |   |   |   |
|---|------------------------------|---|---|---|---|---|---|---|---|
|   | Citigo 5dr (2011 >)          | X | X | X | X | - | - | - | - |
|   | Citigo 5dr (2012 >)          | X | X | - | X | - | - | - | - |
|  | Enyaq EV (2021 >)            | X | X | X | - | - | - | - | - |
|  | Fabia 2015 (2015 >)          | X | X | X | X | - | - | - | - |
|  | Fabia 2021 (2021 >)          | X | X | X | X | - | - | - | - |
|  | Fabia Hatch (2007 >)         | X | X | X | X | - | - | - | - |
|  | Kamiq (2021 >)               | X | X | X | - | - | - | - | - |
|  | Karoq 2017 > (2017 >)        | X | X | X | X | - | - | - | - |
|  | Kodiaq 2017 > (2017 >)       | X | X | X | X | - | X | - | X |
|  | Octavia (2004 - 2012)        | X | X | X | - | - | - | - | - |
|  | Octavia 2020 (2020 >)        | X | X | X | - | - | - | - | - |
|   | Octavia Hatch 2013 (2013 >)  | X | X | X | - | - | - | - | - |
|   | Rapid (2013 >)               | X | X | X | X | - | - | - | - |
|  | Roomster (2006 >)            | X | X | X | X | - | - | - | - |
|  | Scala (2022 >)               | X | X | X | - | - | - | - | - |
|  | Superb 2015 (2015 >)         | X | X | X | - | - | - | - | - |
|   | Superb Combi/Estate (2008 >) | X | X | X | - | - | - | - | - |
|   | Yeti (2009 >)                | X | X | X | X | - | - | - | - |

Smart

|  |                                  |   |   |   |   |   |   |   |   |
|--|----------------------------------|---|---|---|---|---|---|---|---|
|  | For Two Coupe (2007 - 2011)      | X | - | - | - | - | - | - | - |
|  | For Two Coupe 2015 (2015 - 2019) | X | - | - | - | - | - | - | - |
|  | FourFour 2015 (2015 >)           | X | X | - | X | - | - | - | - |

Ssangyong

|  |                            |   |   |   |   |   |   |   |   |
|--|----------------------------|---|---|---|---|---|---|---|---|
|  | Actyon (2006 - 2011)       | X | X | X | - | - | - | - | - |
|  | Korando (2011 >)           | X | X | X | - | - | - | - | - |
|  | Musso Pickup 2016 (2016 >) | X | - | - | - | - | - | - | - |
|  | Rexton (2014 - 2016)       | X | X | X | - | - | - | - | - |
|  | Tivoli (2015 >)            | X | X | X | - | - | - | - | - |
|  | Turismo (2014 >)           | X | - | - | X | X | X | - | - |

Subaru



|  |                      |   |   |   |   |   |   |   |   |
|--|----------------------|---|---|---|---|---|---|---|---|
|  | BRZ (2012 >)         | X | X | - | X | - | - | - | - |
|  | Forester (2013 >)    | X | X | X | - | - | - | - | - |
|  | Impreza 5dr (2007 >) | X | X | X | - | - | - | - | - |

|   |                                 |   |   |   |   |   |   |   |   |
|---|---------------------------------|---|---|---|---|---|---|---|---|
|   | Impreza Hatchback 2013 (2013 >) | X | X | X | - | - | - | - | - |
|  | Legacy (2012 >)                 | X | X | X | - | - | - | - | - |
|  | Levorg 2014 (2014 >)            | X | X | X | X | - | - | - | - |
|   | Outback (2012 >)                | X | X | X | - | - | - | - | - |
|   | XV Hatchback (2011 >)           | X | X | X | - | - | - | - | - |

Suzuki

|   |                           |   |   |   |   |   |   |   |   |
|---|---------------------------|---|---|---|---|---|---|---|---|
|  | Across (2020 >)           | X | X | X | - | - | - | - | - |
|  | Alto (2009 >)             | X | X | - | X | - | - | - | - |
|  | Baleno 2016 (2016 >)      | X | X | X | - | - | - | - | - |
|  | Celerio 2016 5dr (2015 >) | X | X | X | X | - | - | - | - |
|  | Grand Vitara (2005 >)     | X | X | X | - | - | - | - | - |
|  | Ignis 2016 (2016 >)       | X | - | - | X | - | - | - | - |
|   | SX-4 5dr (2006 >)         | X | X | X | - | - | - | - | - |
|  | Splash (2008 >)           | X | X | X | X | - | - | - | - |
|  | Swift 2017 (2017 >)       | X | X | X | - | - | - | - | - |
|   | Swift Sport 5dr (2011 >)  | X | X | X | X | - | - | - | - |
|   | Vitara 2015 (2015 >)      | X | X | X | - | - | - | - | - |

Tesla

|   |                  |   |   |   |   |   |   |   |   |
|---|------------------|---|---|---|---|---|---|---|---|
|  | Model 3 (2017 >) | X | X | X | - | - | - | - | - |
|  | Model 3 (2019 >) | X | X | X | - | - | - | - | - |
|   | Model S (2012 >) | X | X | X | - | - | - | - | - |
|   | Model X (2015 >) | X | - | - | X | - | - | X | - |
|  | Model Y (2022 >) | X | X | X | - | - | - | - | - |

Toyota

|   |                                |   |   |   |   |   |   |   |   |
|---|--------------------------------|---|---|---|---|---|---|---|---|
|   | <b>SB!</b> 2013 Verso (2013 >) | X | X | X | X | - | - | - | - |
|   | Auris (2007 - 2013)            | X | X | X | - | - | - | - | - |
|   | Auris (2013 >)                 | X | X | X | - | - | - | - | - |
|   | Avenis Hatch (2003 - 2011)     | X | X | X | - | - | - | - | - |
|    | Aygo 2014 (2014 >)             | X | X | - | X | - | - | - | - |
|    | Aygo 2019 (2019 >)             | X | X | - | X | - | - | - | - |
|   | Aygo 3dr (2005 >)              | X | X | - | X | - | - | - | - |
|   | Aygo X 2021 (2021 >)           | X | X | X | - | - | - | - | - |
|  | C-HR (2017 >)                  | X | X | X | - | - | - | - | - |
|  | Corolla 2018 (2018 >)          | X | X | X | - | - | - | - | - |
|   | EZ Mpv (2013 >)                | X | X | X | X | - | - | - | - |

|  |                                |   |   |   |   |   |   |   |   |
|--|--------------------------------|---|---|---|---|---|---|---|---|
|  | GT86 (2012 >)                  | X | X | - | X | - | - | - | - |
|  | Highlander (2013 >)            | X | X | X | . | . | - | - | - |
|  | Highlander 2021 (2021 >)       | X | X | X | . | . | - | - | - |
|  | Land Cruiser (2003 - 2009)     | X | X | X | . | . | - | - | - |
|  | Landcruiser (2009 >)           | X | X | X | . | . | - | - | - |
|  | Prius 2 (2004 - 2009)          | X | X | X | . | . | - | - | - |
|  | Prius 3 (2010 >)               | X | X | X | . | . | - | - | - |
|  | Prius 4 (2016) (2015 >)        | X | X | X | . | . | - | - | - |
|  | Prius PHEV 3 (2015>)           | X | X | X | . | . | - | - | - |
|  | Prius Plus+ (2012 >)           | X | X | X | X | . | - | - | - |
|  | RAV 4 (2006 - 2012)            | X | X | X | . | . | - | - | - |
|  | RAV4 (2013 >)                  | X | X | X | . | . | - | - | - |
|  | RAV4 2019 (2019 >)             | X | X | X | . | . | - | - | - |
|  | RAV4 Hybrid (2015 >)           | X | X | X | . | . | - | - | - |
|  | RAV4 Hybrid (2015 >)           | X | X | X | . | . | - | - | - |
|  | <b>SB!</b> Verso (2009 - 2012) | X | X | X | X | . | - | - | - |
|  | Yaris 2017 > (2017 >)          | X | X | X | . | . | - | - | - |
|  | Yaris 2019 (2019 >)            | X | X | X | . | . | - | - | - |
|  | Yaris Cross 2022 (2022 >)      | X | X | X | . | . | - | - | - |
|  | Yaris Hatch (2011 >)           | X | X | X | X | . | - | - | - |
|  | Yaris Hatch 5dr (2006 - 2011)  | X | X | X | X | . | - | - | - |

WW

|  |                                    |   |   |   |   |   |   |   |   |
|--|------------------------------------|---|---|---|---|---|---|---|---|
|  | Amarok Double-Cab (2022>)          | X | . | X | . | . | - | - | - |
|  | Arteon 2017 > (2017 >)             | X | X | X | . | . | - | - | - |
|  | Beetle (2012 >)                    | X | X | - | X | . | - | - | - |
|  | Beetle 1999 (1999 - 2005)          | X | X | - | X | . | - | - | - |
|  | <b>SB!</b> Caddy MaxiLife (2010 >) | X | X | X | . | X | - | X | - |
|  | E-Golf Hatch Mk7 (2015 >)          | X | X | X | . | . | - | - | - |
|  | E-UP! 5dr (2015 >)                 | X | X | X | X | . | - | - | - |
|  | Golf Cabriolet (2009 >)            | X | X | - | X | . | - | - | - |
|  | Golf GTE Hatch Mk7 (2015 >)        | X | X | X | . | . | - | - | - |
|  | Golf Hatch (2009 - 2013)           | X | X | X | X | . | - | - | - |
|  | Golf Hatch Mk5 (2004 - 2008)       | X | X | X | X | . | - | - | - |
|  | Golf Hatch Mk7 (2012 >)            | X | X | X | . | . | - | - | - |
|  | Golf Plus (2009 - 2013)            | X | X | X | X | . | - | - | - |
|  | ID3 EV (2020 >)                    | X | X | X | . | . | - | - | - |
|  | ID4 EV (2021 >)                    | X | X | X | . | . | - | - | - |
|  | ID5 EV (2022 >)                    | X | X | X | . | . | - | - | - |
|  | Jetta (2011 >)                     | X | X | X | . | . | - | - | - |

|  |                                 |   |   |   |   |   |   |   |   |
|--|---------------------------------|---|---|---|---|---|---|---|---|
|  | Lupo (1999 - 2005)              | X | X | - | X | - | - | - | - |
|  | Multivan Caravelle (2008 >)     | X | . | . | . | . | X | . | . |
|  | Passat CC (2008 >)              | X | . | X | . | . | . | X | . |
|  | Passat Estate (2005 - 2011)     | X | X | X | X | . | - | - | - |
|  | Passat Estate (2011-2015)       | X | X | X | X | . | - | - | - |
|  | Passat Estate 2015 (2015 >)     | X | . | X | . | . | - | - | - |
|  | Passat Saloon (2005 - 2011)     | X | . | X | . | . | - | - | - |
|  | Passat Saloon (2011-2015)       | X | . | X | . | . | - | - | - |
|  | Passat Saloon 2015 (2015 >)     | X | . | X | . | . | - | - | - |
|  | Polo 2017 (2017 >)              | X | . | X | . | . | - | - | - |
|  | Polo 3dr (2009 >)               | X | X | X | X | . | - | - | - |
|  | Polo 5dr (2009 >)               | X | X | X | X | . | - | - | - |
|  | Scirocco (2011 >)               | X | . | . | . | . | - | - | - |
|  | <b>SB!</b> Sharan (2010 >)      | X | X | . | X | X | X | - | X |
|  | T-Cross (2019 >)                | X | . | X | . | . | - | - | - |
|  | T-Roc (2017 >)                  | X | . | X | . | . | - | - | - |
|  | Taigo (2022 >)                  | X | . | X | . | . | - | - | - |
|  | Tiguan (2008 >)                 | X | X | X | X | . | - | - | - |
|  | Tiguan 2016 (2016 >)            | X | X | X | X | . | - | - | - |
|  | Tiguan Allspace 2017 > (2017 >) | X | . | X | . | X | X | - | X |
|  | Touareg (2012 >)                | X | . | X | . | . | - | - | - |
|  | Touareg (2003 - 2010)           | X | X | X | X | . | - | - | - |
|  | Touareg 2018 (2018 >)           | X | . | X | . | . | - | - | - |
|  | Touran 2016 (2016 >)            | X | X | . | X | X | - | X | - |
|  | <b>SB!</b> Touran (2010 >)      | X | X | X | X | X | - | X | - |
|  | UP! 5dr (2015 >)                | X | X | X | X | . | - | - | - |

Vauxhall

|  |                            |   |   |   |   |   |   |   |   |
|--|----------------------------|---|---|---|---|---|---|---|---|
|  | Adam (2013 >)              | X | X | - | X | - | - | - | - |
|  | Agila (2008 >)             | X | . | X | . | . | - | - | - |
|  | Ampera (2011 >)            | X | . | . | . | . | - | - | - |
|  | Antara (2007 >)            | X | . | X | . | . | - | - | - |
|  | Astra 2010 5dr (2010 >)    | X | X | X | X | . | - | - | - |
|  | Astra 2015 (2015 >)        | X | . | X | . | . | - | - | - |
|  | Astra GTC (2011 >)         | X | . | X | . | . | - | - | - |
|  | Astra Saloon (1998 - 2004) | X | X | X | X | . | - | - | - |
|  | Corisa 5dr 2015 (2015 >)   | X | . | X | . | . | - | - | - |
|  | Corisa Hatch 5dr (2006 >)  | X | . | X | . | . | - | - | - |
|  | Insignia Hatch (2009 >)    | X | . | X | . | . | - | - | - |
|  | Meriva (2010 >)            | X | X | X | X | . | - | - | - |

① ② ③ ④ ⑤ ⑥ ⑦

|  |                              |   |   |   |   |   |   |   |
|--|------------------------------|---|---|---|---|---|---|---|
|  | Mokka (2013 >)               | X | • | X | • | - | - | - |
|  | Vectra 2005 (2005 - 2008)    | X | • | X | • | - | - | - |
|  | Viva (2015 >)                | X | X | X | X | - | - | - |
|  | Zafira (2005 >)              | X | X | X | X | - | - | - |
|  | Zafira Tourer (2012 >)       | X | X | X | X | X | - | X |
|  | /Opel Crossland X (2018 >)   | X | • | X | • | - | - | - |
|  | /Opel Grandland X (2019 >)   | X | • | X | • | - | - | - |
|  | /Opel Insignia 2018 (2018 >) | X | • | X | • | - | - | - |

**Volvo**

|  |                            |   |   |   |   |   |   |   |
|--|----------------------------|---|---|---|---|---|---|---|
|  | C30 (2007 - 2013)          | X | X | - | X | - | - | - |
|  | S40 (2004 - 2012)          | X | • | X | • | - | - | - |
|  | S90 2016 (2016 >)          | X | • | X | • | - | - | - |
|  | V40 (2013 >)               | X | • | X | • | - | - | - |
|  | V40 Cross Country (2013 >) | X | • | X | • | - | - | - |
|  | V50 (2004 - 2012)          | X | • | X | • | - | - | - |
|  | V60 (2011 >)               | X | X | X | X | - | - | - |
|  | V60 Plug-In (2015 >)       | X | X | X | X | - | - | - |
|  | V60 (2018 >)               | X | • | X | • | - | - | - |
|  | V90 2016 (2016 >)          | X | • | X | • | - | - | - |
|  | XC40 (2018 >)              | X | • | X | • | - | - | - |
|  | XC60 (2013 >)              | X | X | X | X | - | - | - |
|  | XC60 2017 (2017 >)         | X | • | X | • | - | - | - |
|  | XC70 (2008 >)              | X | • | X | • | - | - | - |
|  | XC90 (2003 - 2015)         | X | X | X | X | - | - | - |
|  | XC90 2016 (2016 >)         | X | • | X | • | X | - | X |

**40-105cms RF no SIP**

① ② ③ ④ ⑤ ⑥ ⑦

**Alfa Romeo**

|  |                    |   |   |   |   |   |   |   |
|--|--------------------|---|---|---|---|---|---|---|
|  | 4C Coupe (2014 >)  | X | - | - | - | - | - | - |
|  | Giulia (2017 >)    | X | • | X | • | - | - | - |
|  | Giulietta (2010 >) | X | • | X | • | - | - | - |
|  | MiTo 3dr (2009 >)  | X | X | - | X | - | - | - |
|  | Stelvio (2017 >)   | X | • | X | • | - | - | - |

**Aston Martin**

|  |                  |   |   |   |   |   |   |   |
|--|------------------|---|---|---|---|---|---|---|
|  | DB11 (2019 >)    | X | X | - | X | - | - | - |
|  | DBS (2019 >)     | X | X | - | X | - | - | - |
|  | Vantage (2019 >) | X | - | - | - | - | - | - |

**Audi**

|  |                               |   |   |   |   |   |   |   |
|--|-------------------------------|---|---|---|---|---|---|---|
|  | A1 2018 5dr (2018 >)          | X | • | X | • | - | - | - |
|  | A1 Sportback 5dr (2012 >)     | X | X | X | X | - | - | - |
|  | A3 2004 5dr (2005 - 2011)     | X | • | X | • | - | - | - |
|  | A3 3dr (1996 - 2003)          | X | • | X | • | - | - | - |
|  | A3 Hatch 5dr (2012 >)         | X | • | X | • | - | - | - |
|  | A3 S3 5dr (2012 >)            | X | • | X | • | - | - | - |
|  | A3 Saloon (2014 >)            | X | • | X | • | - | - | - |
|  | A3 e-Tron Sportback (2015 >)  | X | • | X | • | - | - | - |
|  | A4 2005 (2005 - 2008)         | X | • | X | • | - | - | - |
|  | A4 2015 (2015 >)              | X | • | X | • | - | - | - |
|  | A4 Avant (2008 >)             | X | • | X | • | - | - | - |
|  | A5 Sportback (2009 >)         | X | • | X | • | - | - | - |
|  | A5/S5 Cabriolet 2017 (2017 >) | X | • | - | • | - | - | - |
|  | A5/S5 Coupe 2016 (2016 >)     | X | • | - | • | - | - | - |
|  | A5/S5 Sportback 2017 (2017 >) | X | • | X | • | - | - | - |
|  | A6 Allroad (2011 >)           | X | • | X | • | - | - | - |
|  | A6 Avant (2011 >)             | X | • | X | • | - | - | - |
|  | A7 Sportback (2011 >)         | X | • | X | • | - | - | - |
|  | A7/S7 Sportback (2016 >)      | X | • | X | • | - | - | - |
|  | A7/S7 Sportback 2018 (2018 >) | X | • | X | • | - | - | - |
|  | A8 (2011 >)                   | X | • | X | • | - | - | - |
|  | A8 S8 (2011 >)                | X | • | X | • | - | - | - |
|  | A8/S8 2018 (2018 >)           | X | • | X | • | - | - | - |
|  | Q2 (2016 >)                   | X | • | X | • | - | - | - |
|  | Q3 (2011 >)                   | X | • | X | • | - | - | - |

① ② ③ ④ ⑤ ⑥ ⑦

|  |                      |   |   |   |   |   |   |   |   |
|--|----------------------|---|---|---|---|---|---|---|---|
|  | Q3 (2019 >)          | X | . | X | . | . | . | . | . |
|  | Q4 e-Tron (2021 >)   | X | . | X | . | . | . | . | . |
|  | Q5 (2009 >)          | X | . | X | . | . | . | . | . |
|  | Q5/SQ5 2017 (2017 >) | X | . | X | . | . | . | . | . |
|  | Q7 (2006 >)          | X | . | X | . | . | . | . | . |
|  | Q7 2015 (2015 >)     | X | . | X | . | X | . | X | . |
|  | Q8 (2018 >)          | X | . | X | . | . | . | . | . |
|  | TT Coupe (2008 >)    | X | . | X | . | X | . | . | . |

**BMW**

|  |                                    |   |   |   |   |   |   |   |   |
|--|------------------------------------|---|---|---|---|---|---|---|---|
|  | 1 Series (f20) 5dr (2011 >)        | X | . | X | . | . | . | . | . |
|  | 1-Series 5dr (2004 - 2010)         | X | . | X | . | . | . | . | . |
|  | 1-Series Cabrio (2008 >)           | X | . | . | . | . | . | . | . |
|  | 1-Series Coupe (2008 >)            | X | . | . | . | . | . | . | . |
|  | 2-Series AC-T (2015 >)             | X | . | X | . | . | . | . | . |
|  | 2-Series Coupe (2014 >)            | X | . | . | . | . | . | . | . |
|  | 3 Series (f30) (2012 >)            | X | . | X | . | . | . | . | . |
|  | 3-Series (E46) Coupe (2002 - 2006) | X | . | X | . | X | . | . | . |
|  | 3-Series Coupe (E90) (2007 >)      | X | . | . | . | . | . | . | . |
|  | 3GT (2013 >)                       | X | . | X | . | . | . | . | . |
|  | 4-Series Gran Coupe (2014 >)       | X | . | X | . | . | . | . | . |
|  | 5-GT (2010 >)                      | X | . | X | . | . | . | . | . |
|  | 5-Series (F10) (2011 >)            | X | . | X | . | . | . | . | . |
|  | 5-Series (E60) (2003 - 2010)       | X | . | X | . | . | . | . | . |
|  | 5-Series 2018 (2018 >)             | X | . | X | . | . | . | . | . |
|  | 6-Series Cabrio (2011 >)           | X | . | . | . | . | . | . | . |
|  | 6-Series Coupe (2Dr) (2011 >)      | X | . | . | . | . | . | . | . |
|  | 6-Series Gran Coupe (4Dr) (2011 >) | X | . | X | . | . | . | . | . |
|  | 7-Series (2010 >)                  | X | . | X | . | . | . | . | . |
|  | 7-Series 2015 (2015 >)             | X | . | X | . | . | . | . | . |
|  | X1 (2009 - 2015)                   | X | . | X | . | . | . | . | . |
|  | X1 2016 (2016 >)                   | X | . | X | . | . | . | . | . |
|  | X3 (F25) (2011 >)                  | X | . | X | . | . | . | . | . |
|  | X3 2018 (2018 >)                   | X | . | X | . | . | . | . | . |
|  | X4 (2014 >)                        | X | . | X | . | . | . | . | . |
|  | X5 2000 (2000 - 2006)              | X | . | X | . | X | . | . | . |
|  | X5 2007 (2007 - 2014)              | X | . | X | . | X | . | X | . |
|  | X5 2015 (2015 >)                   | X | . | X | . | X | . | X | . |
|  | X6 (2009 >)                        | X | . | X | . | . | . | . | . |
|  | X6 2015 (2015 >)                   | X | . | . | . | . | . | . | . |

① ② ③ ④ ⑤ ⑥ ⑦

|  |              |   |   |   |   |   |   |   |   |
|--|--------------|---|---|---|---|---|---|---|---|
|  | i3 (2014 >)  | X | . | . | . | . | . | . | . |
|  | i8 (2014 >)  | X | X | . | X | . | . | . | . |
|  | iX (2021 >)  | X | . | X | . | . | . | . | . |
|  | iX3 (2022 >) | X | . | X | . | . | . | . | . |

**Bentley**

|  |                                   |   |   |   |   |   |   |   |   |
|--|-----------------------------------|---|---|---|---|---|---|---|---|
|  | Continental Flying Spur (2005 >)  | X | . | X | . | . | . | . | . |
|  | Continental GT (2003 - 2012)      | X | X | . | X | . | . | . | . |
|  | Continental GT Conv (2006 - 2012) | X | X | . | X | . | . | . | . |
|  | Mulsanne (2012 >)                 | X | . | X | . | . | . | . | . |

**Cadillac**

|  |                   |   |   |   |   |   |   |   |   |
|--|-------------------|---|---|---|---|---|---|---|---|
|  | BLS (2005 - 2012) | X | . | X | . | . | . | . | . |
|--|-------------------|---|---|---|---|---|---|---|---|

**Chevrolet**

|  |                    |   |   |   |   |   |   |   |   |
|--|--------------------|---|---|---|---|---|---|---|---|
|  | Aveo 5dr (2012 >)  | X | X | X | X | . | . | . | . |
|  | Captiva (2010 >)   | X | . | X | . | . | . | . | . |
|  | Cruze (2011 >)     | X | . | X | . | . | . | . | . |
|  | Orland (2011 >)    | X | . | X | . | . | . | . | . |
|  | Spark 5dr (2012 >) | X | X | X | X | . | . | . | . |
|  | Traxx (2013 >)     | X | . | X | . | . | . | . | . |
|  | Volt (2011 >)      | X | . | . | . | . | . | . | . |

**Chrysler**

|  |                        |   |   |   |   |   |   |   |   |
|--|------------------------|---|---|---|---|---|---|---|---|
|  | 300C (2012 >)          | X | . | X | . | . | . | . | . |
|  | Delta (2007 >)         | X | . | X | . | . | . | . | . |
|  | Grand Voyager (2008 >) | X | . | . | . | X | X | X | . |
|  | Ypsilon 3dr (2012 >)   | X | X | X | X | . | . | . | . |

**Citroen**

|  |   |   |   |   |   |   |   |   |   |
|--|---|---|---|---|---|---|---|---|---|
|  | <b>SB!</b> Berlingo II (2008 >)         | X | . | X | . | . | . | . | . |
|  | <b>SB!</b> Berlingo Multispace (2007 >) | X | X | X | X | X | . | X | . |
|  | C-Cactus (2015)                         | X | . | X | . | . | . | . | . |
|  | C1 2015 5dr (2015 >)                    | X | X | . | X | . | . | . | . |
|  | C1 3dr (2006 >)                         | X | X | . | X | . | . | . | . |
|  | C3 5Dr (2009 >)                         | X | . | X | . | . | . | . | . |

|            |                                  |   |   |   |   |   |   |   |
|------------|----------------------------------|---|---|---|---|---|---|---|
|            | C3 5dr 2005 (2005 - 2009)        | X | • | X | • | - | - | - |
|            | C3 5dr 2016 (2016 >)             | X | • | X | • | - | - | - |
|            | C3 Aircross (2017 >)             | X | • | X | • | - | - | - |
|            | <b>SB!</b> C3 Picasso (2009 >)   | X | • | X | • | - | - | - |
| <b>SB!</b> | C4 G-Picasso 2007 (2007 - 2013)  | X | • | • | X | X | - | X |
|            | <b>SB!</b> C4 G-Picasso (2014 >) | X | • | • | X | X | - | X |
| <b>SB!</b> | C4 Picasso (2007 - 2013)         | X | • | X | • | - | - | - |
|            | C5 (2008 >)                      | X | • | X | • | - | - | - |
|            | C5 2005 (2005 - 2008)            | X | • | X | • | - | - | - |
|            | C5 Aircross (2019 >)             | X | X | X | • | - | - | - |
|            | C5 Tourer (2009 >)               | X | • | X | • | - | - | - |
|            | DS3 (2011 >)                     | X | • | X | • | - | - | - |
|            | DS3 Cabrio (2013 >)              | X | • | X | • | - | - | - |
|            | DS3 Crossback (2019 >)           | X | • | X | • | - | - | - |
|            | DS4 (2011 >)                     | X | • | X | • | - | - | - |
|            | DS5 (2013 >)                     | X | • | X | • | - | - | - |
|            | DS7 (2018 >)                     | X | • | X | • | - | - | - |
|            | Jumpy (2007 - 2016)              | X | • | X | • | X | - | X |
|            | Nemo (2008 >)                    | X | • | X | • | - | - | - |
|            | Xsara 5dr (2000 - 2004)          | X | X | X | • | - | - | - |
| <b>SB!</b> | Xsara Picasso (2000 - 2012)      | X | • | X | • | - | - | - |

Dacia

|  |                                 |   |   |   |   |   |   |   |
|--|---------------------------------|---|---|---|---|---|---|---|
|  | Duster (2012 >)                 | X | • | X | • | - | - | - |
|  | Jogger (2022 >)                 | X | • | X | • | - | - | - |
|  | Logan MCV (2013 >)              | X | • | X | • | - | - | - |
|  | Logan MCV 2006 (2008/11-2013/7) | X | • | X | • | - | - | - |
|  | Sandero (2013 >)                | X | • | X | • | - | - | - |

FIAT

|  |                                   |   |   |   |   |   |   |   |
|--|-----------------------------------|---|---|---|---|---|---|---|
|  | 124 Spider 2016 (2016 >)          | X | - | - | - | - | - | - |
|  | 500 (2008 >)                      | X | X | - | X | - | - | - |
|  | 500L (2013 >)                     | X | • | X | • | - | - | - |
|  | 500X (2015 >)                     | X | • | X | • | - | - | - |
|  | Bravo (2007 >)                    | X | • | X | • | - | - | - |
|  | Doblo (2007 >)                    | X | • | X | • | - | - | - |
|  | Panda (2012 >)                    | X | X | X | • | - | - | - |
|  | Punto 3dr (Grande Punto) (2006 >) | X | X | X | • | - | - | - |
|  | Qubo (2008 >)                     | X | • | X | • | - | - | - |

Ford

|            |                                   |   |   |   |   |   |   |   |
|------------|-----------------------------------|---|---|---|---|---|---|---|
|            | Tipo 2016 (2016 >)                | X | • | X | • | - | - | - |
|            | Galaxy 2016 (2016 >)              | X | • | X | • | X | - | X |
|            | B-Max (2012 >)                    | X | • | X | • | - | - | - |
|            | C-Max 2013 (2011 >)               | X | • | X | • | - | - | - |
| <b>SB!</b> | C-Max (2003 - 2013)               | X | X | X | • | - | - | - |
|            | EcoSport (2015 >)                 | X | • | X | • | - | - | - |
| <b>SB!</b> | Edge (2016 >)                     | X | • | X | • | X | - | X |
|            | Fiesta 2004 3dr (2004 - 2008)     | X | X | X | • | - | - | - |
|            | Fiesta 2008 5dr (2008 >)          | X | • | X | • | - | - | - |
|            | Fiesta 2017 > (2017 >)            | X | • | X | • | - | - | - |
|            | Focus (2010 >)                    | X | • | X | • | - | - | - |
|            | Focus 2005 (2005 - 2009)          | X | X | X | • | - | - | - |
|            | Focus 2018 (2018 >)               | X | • | X | • | - | - | - |
|            | Focus EV (2015 >)                 | X | • | X | • | - | - | - |
|            | Focus Mk1 (1998 - 2004)           | X | X | X | • | - | - | - |
|            | Galaxy (2006 >)                   | X | • | X | • | X | - | X |
|            | Ka 3dr (2009 - 2013)              | X | X | - | X | - | - | - |
|            | Ka+ 2016 5dr (2016 >)             | X | • | X | • | - | - | - |
|            | Kuga 2008 (2008 - 2012)           | X | • | X | • | - | - | - |
|            | Kuga 2013 (2013 >)                | X | • | X | • | - | - | - |
|            | Kuga 2017 (2017 >)                | X | • | X | • | - | - | - |
|            | Kuga 2020 (2020 >)                | X | • | X | • | - | - | - |
|            | Mondeo 2000 (2000 - 2007)         | X | X | X | • | - | - | - |
|            | Mondeo Estate (2007 >)            | X | • | X | • | - | - | - |
|            | Mustang Cabrio 2015 (2015 >)      | X | X | - | X | - | - | - |
|            | Mustang Coupe 2015 (2015 >)       | X | X | - | X | - | - | - |
|            | Mustang Mach E (2022 >)           | X | • | X | • | - | - | - |
|            | New Mondeo 2014 (2014 >)          | X | • | X | • | - | - | - |
|            | Puma (2020 >)                     | X | • | X | • | - | - | - |
|            | Ranger Double-Cab Pickup (2019 >) | X | • | X | • | - | - | - |
|            | S-Max (2006 >)                    | X | • | X | • | X | - | X |
|            | S-Max 2015 (2015 >)               | X | • | X | • | X | - | X |
|            | G80 (2021 >)                      | X | • | X | • | - | - | - |
|            | GV80 SUV (2021 >)                 | X | • | X | • | - | - | - |

Genesis



Honda

|  |                             |   |   |   |   |   |   |   |
|--|-----------------------------|---|---|---|---|---|---|---|
|  | Accord Saloon (2008 >)      | X | • | X | • | - | - | - |
|  | CR-V (2007 - 2012)          | X | • | X | • | - | - | - |
|  | CR-V 2012 (2012 >)          | X | • | X | • | - | - | - |
|  | CR-V 2019 (2019 >)          | X | • | X | • | X | - | X |
|  | Civic (2012 >)              | X | • | X | • | - | - | - |
|  | Civic (2006 - 2011)         | X | • | X | • | - | - | - |
|  | Civic 2017 (2017 >)         | X | • | X | • | - | - | - |
|  | Civic Saloon 2019 (2019 >)  | X | • | X | • | - | - | - |
|  | Civic Tourer (2014 >)       | X | • | X | • | - | - | - |
|  | E (2021>)                   | X | • | X | • | - | - | - |
|  | Elysion (2012 >)            | X | • | - | • | X | X | X |
|  | FRV (2006 - 2011)           | X | • | X | • | - | - | - |
|  | HR-V (2015 >)               | X | • | X | • | - | - | - |
|  | HR-V 2022 (2022 >)          | X | • | X | • | - | - | - |
|  | Insight (2009 >)            | X | X | X | X | - | - | - |
|  | Jazz (2008 - 2015)          | X | • | X | • | - | - | - |
|  | Jazz 2002 (2002 - 2008)     | X | X | X | X | - | - | - |
|  | Jazz 2016 (2016 >)          | X | • | X | • | - | - | - |
|  | Jazz 2020 (2020 >)          | X | • | X | • | - | - | - |
|  | Jazz Crosstar 2021 (2021 >) | X | • | X | • | - | - | - |
|  | Odyssey (2010 >)            | X | X | - | X | - | - | - |

Hyundai

|  |                             |   |   |   |   |   |   |   |
|--|-----------------------------|---|---|---|---|---|---|---|
|  | Genesis Sedan (2016 >)      | X | • | X | • | - | - | - |
|  | Getz 5dr (2005 - 2011)      | X | • | X | • | - | - | - |
|  | Ioniq Hybrid (2016 >)       | X | • | X | • | - | - | - |
|  | Ix20 (2011 >)               | X | • | X | • | - | - | - |
|  | Kona 2017 > (2017 >)        | X | • | X | • | - | - | - |
|  | Santa Fe (2012 >)           | X | • | X | • | X | - | X |
|  | Santa Fe 2007 (2007 - 2012) | X | • | X | • | X | - | X |
|  | Tucson 2015 (2015 >)        | X | • | X | • | - | - | - |
|  | Veloster (2012 >)           | X | • | X | • | X | - | X |
|  | i10 2014 5dr (2014 >)       | X | • | X | • | - | - | - |
|  | i10 5dr (2008 >)            | X | X | X | X | - | - | - |
|  | i20 2014 > (2014 >)         | X | • | X | • | - | - | - |
|  | i20 2015 (2015 >)           | X | • | X | • | - | - | - |
|  | i20 Hatch (2009 >)          | X | X | X | X | - | - | - |
|  | i30 Hatch (2012 >)          | X | • | X | • | - | - | - |

|  |                              |   |   |   |   |   |   |   |
|--|------------------------------|---|---|---|---|---|---|---|
|  | i30 Hatch 2015 (2015 - 2017) | X | • | X | • | - | - | - |
|  | i30 Hatch 2017 (2017 >)      | X | • | X | • | - | - | - |
|  | i40 (2011 >)                 | X | • | X | • | - | - | - |
|  | i800/H1 (2008 >)             | X | • | X | • | X | X | X |
|  | ix35 (2010 >)                | X | • | X | • | - | - | - |

Infiniti

|  |                   |   |   |   |   |   |   |   |
|--|-------------------|---|---|---|---|---|---|---|
|  | EX SUV (2009 >)   | X | • | X | • | - | - | - |
|  | FX SUV (2009 >)   | X | • | X | • | - | - | - |
|  | G Coupe (2009 >)  | X | X | - | X | - | - | - |
|  | G Saloon (2009 >) | X | • | X | • | - | - | - |
|  | M Saloon (2010 >) | X | • | X | • | - | - | - |

Jaguar

|  |  |                         |   |   |   |   |   |   |
|--|--|-------------------------|---|---|---|---|---|---|
|  |  | E-Pace (2018 >)         | X | • | X | • | - | - |
|  |  | F-Pace (2016 >)         | X | • | X | • | - | - |
|  |  | F-Type Coupe (2014 >)   | X | - | - | - | - | - |
|  |  | I-Pace (2018 >)         | X | • | X | • | - | - |
|  |  | X-Type (2001 - 2010)    | X | X | X | X | - | - |
|  |  | XE (2015 >)             | X | • | X | • | - | - |
|  |  | XF (2008 >)             | X | • | X | • | - | - |
|  |  | XF 2015 (2015 >)        | X | • | X | • | - | - |
|  |  | XF Estate 2015 (2015 >) | X | • | X | • | - | - |
|  |  | XF Sportbrake (2012 >)  | X | • | X | • | - | - |
|  |  | XJ (2010 >)             | X | • | X | • | - | - |
|  |  | XK Coupe (2006 >)       | X | X | - | X | - | - |

Jeep

|  |  |                         |   |   |   |   |   |   |
|--|--|-------------------------|---|---|---|---|---|---|
|  |  | Cherokee 2014 (2014 >)  | X | • | X | • | - | - |
|  |  | Compass (2011 >)        | X | • | X | • | - | - |
|  |  | Grand Cherokee (2011 >) | X | • | X | • | - | - |
|  |  | Renegade 2015 (2015 >)  | X | • | X | • | - | - |
|  |  | Wrangler 5Dr (2007 >)   | X | X | X | X | - | - |

Kia

|  |  |                    |   |   |   |   |   |   |
|--|--|--------------------|---|---|---|---|---|---|
|  |  | Ceed 2020 (2020 >) | X | • | X | • | - | - |
|  |  | EV6 (2022 >)       | X | • | X | • | - | - |

|            |                                |   |   |   |   |   |   |   |
|------------|--------------------------------|---|---|---|---|---|---|---|
|            | Sorento 2015 (2015 >)          | X | • | X | • | X | - | X |
|            | Sorento 2020 (2020 >)          | X | • | X | • | X | - | X |
|            | Soul EV (2015 >)               | X | • | X | • | - | - | - |
|            | Soul EV 2019 (2019 >)          | X | • | X | • | - | - | - |
|            | XCEED (2020 >)                 | X | • | X | • | - | - | - |
| <b>SB!</b> | Carens 2013 (2013 >)           | X | • | X | • | X | - | X |
|            | Cee'D Hatch (2012 >)           | X | • | X | • | - | - | - |
|            | Cee'D Hatch (2012 >)           | X | • | X | • | - | - | - |
|            | Niro 2017 (2017 >)             | X | • | X | • | - | - | - |
|            | Niro Hybrid 2022 (2022 >)      | X | • | X | • | - | - | - |
|            | Optima (2011 >)                | X | • | X | • | - | - | - |
|            | Optima 2016 (2016 >)           | X | • | X | • | - | - | - |
|            | Picanto 2012 5dr (2011 - 2015) | X | • | X | • | - | - | - |
|            | Picanto 2017 > (2017 >)        | X | • | X | • | - | - | - |
|            | Picanto 5dr (2008 >)           | X | • | X | • | X | - | - |
|            | Rio (2012 >)                   | X | • | X | • | - | - | - |
|            | Rio 2017 > (2017 >)            | X | • | X | • | - | - | - |
|            | Sorento (2012 >)               | X | • | X | • | - | - | - |
|            | Sorento (2003 - 2009)          | X | • | X | • | - | - | - |
|            | Soul (2009 >)                  | X | • | X | • | - | - | - |
|            | Sportage (2011 >)              | X | • | X | • | - | - | - |
|            | Sportage 2016 (2016 >)         | X | • | X | • | - | - | - |
|            | Sportage 2022 (2022 >)         | X | • | X | • | - | - | - |
|            | Stonic 2017 > (2017 >)         | X | • | X | • | - | - | - |
|            | Venga (2011 >)                 | X | • | X | • | - | - | - |

Lancia

|  |                      |   |   |   |   |   |   |   |
|--|----------------------|---|---|---|---|---|---|---|
|  | Thema (2012 >)       | X | • | X | • | - | - | - |
|  | Voyager (2010 >)     | X | • | - | • | X | X | X |
|  | Ypsilon 3dr (2012 >) | X | • | X | • | X | - | - |

Land Rover

|  |                           |   |   |   |   |   |   |   |
|--|---------------------------|---|---|---|---|---|---|---|
|  | Defender 2020 (2020 >)    | X | • | X | • | X | - | X |
|  | Discovery 4 (2009 >)      | X | • | X | • | - | - | - |
|  | Discovery 5 2017 (2017 >) | X | • | X | • | X | - | X |
|  | Discovery Sport (2015 >)  | X | • | X | • | X | - | X |
|  | Freelander 2 (2006 >)     | X | • | X | • | - | - | - |
|  | Range Rover (2002 - 2012) | X | • | X | • | - | - | - |
|  | Range Rover 2013 (2013 >) | X | • | X | • | - | - | - |



|  |  |   |   |   |   |   |   |   |
|--|--|---|---|---|---|---|---|---|
|  | Range Rover Evoque (2011 >)            | X | • | X | • | - | - | - |
|  | Range Rover Evoque (5dr) 2019 (2019 >) | X | • | X | • | - | - | - |
|  | Range Rover Evoque 5 door (2011 >)     | X | • | X | • | - | - | - |
|  | Range Rover Sport (2005 - 2012)        | X | • | X | • | - | - | - |
|  | Range Rover Sport (2013 >)             | X | • | X | • | - | - | - |
|  | Range Rover VELAR (2017 >)             | X | • | X | • | - | - | - |

Lexus



|  |                        |   |   |   |   |   |   |   |
|--|------------------------|---|---|---|---|---|---|---|
|  | CT (2011 >)            | X | • | X | • | - | - | - |
|  | ES Hybrid (2019 >)     | X | • | X | • | - | - | - |
|  | GS (2013 >)            | X | • | X | • | - | - | - |
|  | IS (2005 >)            | X | • | X | • | - | - | - |
|  | IS 200 (2004) (1999 >) | X | • | X | • | - | - | - |
|  | NX (2014 >)            | X | • | X | • | - | - | - |
|  | RX (2010 >)            | X | • | X | • | - | - | - |
|  | RX 2016 (2017 >)       | X | • | X | • | - | - | - |
|  | UX (2019 >)            | X | • | X | • | - | - | - |

MG



|  |                      |   |   |   |   |   |   |   |
|--|----------------------|---|---|---|---|---|---|---|
|  | 5 EV Estate (2020 >) | X | • | X | • | - | - | - |
|  | GS (2016 >)          | X | • | X | • | - | - | - |
|  | HS PHEV SUV (2021 >) | X | • | X | • | - | - | - |
|  | HS SUV (2021 >)      | X | • | X | • | - | - | - |
|  | Motor MG6 (2012 >)   | X | • | X | • | - | - | - |
|  | ZS (2021 >)          | X | • | X | • | - | - | - |
|  | ZS EV (2021 >)       | X | • | X | • | - | - | - |



MINI

|  |                             |   |   |   |   |   |   |   |
|--|-----------------------------|---|---|---|---|---|---|---|
|  | Countryman (2010 >)         | X | • | X | • | - | - | - |
|  | Coupe (2009 >)              | X | - | - | - | - | - | - |
|  | Hatch (2006 >)              | X | X | - | X | - | - | - |
|  | Hatchback 3Dr 2014 (2014 >) | X | • | - | - | - | - | - |
|  | Hatchback 3dr (2000 - 2006) | X | • | X | • | X | - | - |
|  | Hatchback 5dr 2015 (2015 >) | X | • | X | • | - | - | - |
|  | Paceman (2013 >)            | X | • | - | - | - | - | - |







**Maserati**











|                            |   |   |   |   |   |   |   |   |
|----------------------------|---|---|---|---|---|---|---|---|
| Ghibli 2014 (2014 >)       | X | . | X | . | - | - | - | - |
| Gran Turismo 2007 (2007 >) | X | X | - | X | - | - | - | - |
| Levante (2017 >)           | X | X | . | . | - | - | - | - |
| Quattroporte 2016 (2016 >) | X | . | X | . | . | - | - | - |

**Mazda**



|   |   |   |   |   |   |   |   |   |
|---|---|---|---|---|---|---|---|---|
| 2 (2007 >)  | X | . | X | . | . | - | - | - |
|  2 2015 5dr (2015 >) | X | . | X | . | . | - | - | - |
| 3 Hatch (2009 - 2013)   | X | . | X | . | . | - | - | - |
| 3 Hatchback 2014 (2014 >)   | X | . | X | . | . | - | - | - |
| 5 (2005 - 2010)   | X | . | X | . | . | - | - | - |
| 6 (2007 - 2012)   | X | . | X | . | . | - | - | - |
|  6 2018 (2018 >)     | X | . | X | . | . | - | - | - |
| 6 Estate (2013 >)   | X | . | X | . | . | - | - | - |
| 6 Saloon (2013 >)   | X | . | X | . | . | - | - | - |
|  CX-3 (2015 >)       | X | . | X | . | . | - | - | - |
| CX-5 (2011 >)   | X | . | X | . | . | - | - | - |
| CX-7 (2007 >)   | X | . | X | . | . | - | - | - |
| MX-5 2015 (2016 >)  | X | . | - | - | - | - | - | - |

**Mercedes-Benz**



|   |   |   |   |   |   |   |   |   |
|---|---|---|---|---|---|---|---|---|
| A Class (2005 - 2012)   | X | . | X | . | . | - | - | - |
|  A-Class (2013 >)                | X | . | X | . | . | - | - | - |
|  A-Class Hatchback 2019 (2019 >) | X | . | X | . | . | - | - | - |
|  A-Class Saloon 2019 (2020 >)    | X | . | X | . | . | - | - | - |
| B-Class (2012 >)  | X | . | X | . | . | - | - | - |
| B-Class EV (2015 >)   | X | . | X | . | . | - | - | - |
| C-Class 2015 Estate (2015 >)  | X | . | X | . | . | - | - | - |
| C-Class Coupe (2011 >)  | X | . | . | . | . | - | - | - |
| C-Class Estate (2008 >)   | X | . | X | . | . | - | - | - |
|  CLA (2013 >)                    | X | . | X | . | . | - | - | - |
|  CLA 2019 (2020 >)               | X | . | X | . | . | - | - | - |
|  CLA Shooting-Brake (2015 >)     | X | . | X | . | . | - | - | - |
| CLS Coupe (2011 >)  | X | . | X | . | . | - | - | - |
| CLS Shooting Brake (2012 >)   | X | . | X | . | . | - | - | - |
| E-Class 2006 (2006 - 2009)  | X | . | X | . | . | - | - | - |
| E-Class Cabriolet 2017 (2017 >)   | X | . | - | . | . | - | - | - |

|   |   |   |   |   |   |   |   |   |
|---|---|---|---|---|---|---|---|---|
| E-Class Coupe (2009 >)  | X | . | . | . | . | - | - | - |
|  E-Class Coupe 2017 (2017 >) | X | . | . | . | . | - | - | - |
|  E-Class Estate (2013 >)     | X | . | X | . | . | - | - | - |
| E-Class Estate 2016 (2016 >)  | X | . | X | . | . | - | - | - |
| E-Class Saloon 2013 (2013 >)  | X | . | X | . | . | - | - | - |
|  EQA 2021 (2021 >)           | X | . | X | . | . | - | - | - |
|  EQC (2021 >)                | X | . | X | . | . | - | - | - |
|  GL Class (2012 >)           | X | . | X | . | X | - | X | - |
|  GLA 2021 (2021 >)           | X | . | X | . | . | - | - | - |
|  GLC (2016 >)                | X | . | X | . | . | - | - | - |
|  GLC Coupe (2019 >)          | X | . | X | . | . | - | - | - |
|  GLE (2015 >)                | X | . | X | . | . | - | - | - |
|  GLE 2020 (2020 >)           | X | . | X | . | X | - | X | - |
| R-Class (2006 - 2012)   | X | . | X | . | . | - | - | - |
| S Class 2015 (2014 >)   | X | . | X | . | . | - | - | - |
| S-Class (2006 - 2013)   | X | . | X | . | . | - | - | - |
| SL-Class (2012 >)   | X | . | - | - | - | - | - | - |
| SLK (2012 >)  | X | . | - | - | - | - | - | - |
| V-Class (2015 >)  | X | . | X | . | . | . | X | . |

**Mini**

|   |   |   |   |   |   |   |   |   |
|---|---|---|---|---|---|---|---|---|
|   Clubman 2016 (2016 >) | X | . | X | . | . | - | - | - |
|  Countryman 2017 (2017 >)  | X | . | X | . | . | - | - | - |

**Mitsubishi**

|  |   |   |   |   |   |   |   |   |
|--|---|---|---|---|---|---|---|---|
| ASX (2010 >)   | X | . | X | . | . | - | - | - |
|  Colt (2007 - 2013)     | X | X | X | X | . | - | - | - |
|  Eclipse Cross (2019 >) | X | . | X | . | . | - | - | - |
| Lancer (2008 - 2011 >)   | X | . | - | - | - | - | - | - |
| Lancer Sportback (2008 - 2011 >)   | X | . | - | - | - | - | - | - |
| Mirage (2012 >)  | X | . | X | . | . | - | - | - |
| Outlander (2007 - 2013)  | X | . | X | . | . | - | - | - |
| Outlander (2013 >)   | X | . | X | . | . | - | - | - |
| Outlander PHEV (2015 >)  | X | . | X | . | . | - | - | - |
| Shogun (2007 >)  | X | . | X | . | . | - | - | - |

**Nissan**

|                       |   |   |   |   |   |   |   |   |
|-----------------------|---|---|---|---|---|---|---|---|
| 2008 X-Trail (2008 >) | X | . | X | . | . | - | - | - |
|-----------------------|---|---|---|---|---|---|---|---|

① ② ③ ④ ⑤ ⑥ ⑦

|                            |   |   |   |   |   |   |   |   |
|----------------------------|---|---|---|---|---|---|---|---|
| Juke (2010 >)              | X | . | X | . | . | . | . | . |
| Leaf EV (2010 - 2017)      | X | . | X | . | . | . | . | . |
| Micra 2017 > (2017 >)      | X | . | X | . | . | . | . | . |
| Micra 5dr (2011 >)         | X | X | X | X | . | . | . | . |
| Murano 2016 (2016 >)       | X | . | X | . | . | . | . | . |
| Navara 2015 > (2015 >)     | X | . | X | . | . | . | . | . |
| Note (2006 - 2013)         | X | X | X | X | . | . | . | . |
| Note 2014 (2014 >)         | X | . | X | . | . | . | . | . |
| Pulsar 2015 (2015 >)       | X | . | X | . | . | . | . | . |
| Qashqai 2007 (2006 - 2013) | X | . | X | . | . | . | . | . |
| Qashqai 2014 (2014 >)      | X | . | X | . | . | . | . | . |
| Qashqai+2 (2008 >)         | X | . | X | . | . | . | . | . |
| Quest MPV (2012 >)         | X | . | . | . | X | X | X | X |
| X-Trail 2015 (2015 >)      | X | . | X | . | X | . | X | . |







Opel

|   |   |   |   |   |   |   |   |   |
|---|---|---|---|---|---|---|---|---|
| Adam (2013 >)   | X | . | . | . | . | . | . | . |
| Agila (2008 >)  | X | . | X | . | . | . | . | . |
| Ampera (2011 >)   | X | . | . | . | . | . | . | . |
| Antara (2007 >)   | X | . | X | . | . | . | . | . |
| Astra 2003 5dr (2003 - 2009)  | X | . | X | . | . | . | . | . |
|  Astra 2010 5dr (2010 >) | X | . | X | . | . | . | . | . |
| Astra 2015 (2015 >)   | X | . | X | . | . | . | . | . |
| Astra GTC (2011 >)  | X | . | X | . | . | . | . | . |
| Corsa 5dr 2015 (2015 >)   | X | . | X | . | . | . | . | . |
| Corsa Hatch 5dr (2006 >)  | X | . | X | . | . | . | . | . |
| Insignia Hatch (2009 >)   | X | . | X | . | . | . | . | . |
| Karl (2015 >)   | X | X | X | X | . | . | . | . |
| Meriva (2010 >)   | X | . | X | . | . | . | . | . |
| Mokka (2013 >)  | X | . | X | . | . | . | . | . |
| Vectra 2005 (2002 - 2008)   | X | . | X | . | . | . | . | . |
| Zafira (2005 >)   | X | . | X | . | . | . | . | . |
| Zafira Tourer (2012 >)  | X | . | X | . | X | . | X | . |

Peugeot

|   |   |   |   |   |   |   |   |   |
|---|---|---|---|---|---|---|---|---|
| 107 3dr (2005 - 2013)   | X | X | . | X | . | . | . | . |
| 108 5dr (2015 >)  | X | X | . | X | . | . | . | . |
|  2008 (2013 >) | X | . | X | . | . | . | . | . |
| 2008 2020 (2020 >)  | X | . | X | . | . | . | . | . |

① ② ③ ④ ⑤ ⑥ ⑦

|  |   |   |   |   |   |   |   |   |
|--|---|---|---|---|---|---|---|---|
| 206 3dr (1998 - 2009)  | X | . | X | . | . | . | . | . |
| 207 3dr Hatchback (2006 - 2012)  | X | X | X | X | . | . | . | . |
| 207 5dr (2012 >)   | X | . | X | . | . | . | . | . |
|  208 2020 5dr (2020 >)        | X | . | X | . | . | . | . | . |
| 208 5dr (2012 >)   | X | . | X | . | . | . | . | . |
|  208 EV 2020 5dr (2020 >)     | X | . | X | . | . | . | . | . |
|  3008 2017 (2017 >)           | X | . | X | . | . | . | . | . |
| <b>SB!</b> 3008 (2009 >)   | X | . | X | . | . | . | . | . |
| 307 Hatchback (2001 - 2007)  | X | . | X | . | . | . | . | . |
| 308 (2014) (2014 >)  | X | . | X | . | . | . | . | . |
| 308 Hatchback (2007 >)   | X | . | X | . | . | . | . | . |
| 407 (2004 - 2011)  | X | . | X | . | . | . | . | . |
|  <b>SB!</b> 5008 (2011 >)     | X | . | . | . | . | X | . | X |
|  <b>SB!</b> 5008 (2018 >)     | X | . | . | . | . | X | . | X |
| 508 (2011 >)   | X | . | X | . | . | . | . | . |
|  508 2019 (2018 >)            | X | . | X | . | . | . | . | . |
|  508 Estate PHEV 2019 (2019 >) | X | . | X | . | . | . | . | . |
| Bipper Tepee (2008 >)  | X | . | X | . | . | . | . | . |
| Expert Tepee (2008 >)  | X | . | X | . | X | . | X | . |
| Partner Combi (2004 - 2010)  | X | X | X | X | . | . | . | . |
| <b>SB!</b> Partner Teeppee (2008 >)  | X | . | X | . | . | . | . | . |
| RCZ (2011 >)   | X | X | . | X | . | . | . | . |
| Traveller 2016 (2016 >)  | X | . | . | . | . | . | . | . |

Polestar

|  |   |   |   |   |   |   |   |   |
|--|---|---|---|---|---|---|---|---|
|  2 (2021 >) | X | . | X | . | . | . | . | . |
|--|---|---|---|---|---|---|---|---|





Porsche

|  |   |   |   |   |   |   |   |   |
|--|---|---|---|---|---|---|---|---|
|  Cayenne (2011 >) | X | . | X | . | . | . | . | . |
| Cayenne 2017 (2017 >)  | X | . | X | . | . | . | . | . |
| Cayenne E-Hybrid (2015 >)  | X | . | X | . | . | . | . | . |
| Macan (2014 >)   | X | . | X | . | . | . | . | . |
| Panamera (2011 >)  | X | . | . | . | . | . | . | . |
| Panamera E-Hybrid (2015 >)   | X | . | . | . | . | . | . | . |

Renault

|                        |   |   |   |   |   |   |   |   |
|------------------------|---|---|---|---|---|---|---|---|
| Captur (2015 >)        | X | . | X | . | . | . | . | . |
| Clio 5dr (2005 - 2013) | X | . | X | . | . | . | . | . |

① ② ③ ④ ⑤ ⑥ ⑦

|  |   |   |   |   |   |   |   |   |
|--|---|---|---|---|---|---|---|---|
| Clio 5dr 2013 (2013 >)   | X | . | X | . | . | - | - | - |
| Espace (2003 - 2012)   | X | . | . | . | X | - | X |   |
| Grand Espace (2003 - 2012)   | X | . | . | . | X | - | X |   |
| Kadjar (2015 >)  | X | . | X | . | . | - | - | - |
|  Koleos 2018 (2018 >)             | X | . | X | . | . | - | - | - |
| Laguna Sport Tourer (2008 - 2012)  | X | . | X | . | . | - | - | - |
|  Megane Hatch 2016 (2016 >)       | X | . | X | . | . | - | - | - |
|  <b>SB!</b> Megane Hatch (2008 >) | X | . | X | . | . | - | - | - |
| <b>SB!</b> Megane Hatch (2002 - 2009)  | X | . | X | . | . | - | - | - |
| Modus (2004 - 2012)  | X | . | X | . | . | - | - | - |
| <b>SB!</b> Scenic 2003 (2003 - 2009)   | X | . | X | . | . | - | - | - |
|  <b>SB!</b> Scenic 2017 (2017 >)  | X | . | . | . | . | - | - | - |
|  <b>SB!</b> Scenic (2009 >)       | X | . | X | . | . | - | - | - |
| Twingo 2015 (2015 >)   | X | X | - | X | . | - | - | - |
| Twingo 3dr (2007 >)  | X | X | - | X | . | - | - | - |







Rover

|                               |   |   |   |   |   |   |   |   |
|-------------------------------|---|---|---|---|---|---|---|---|
| 25 / Streetwise (1999 - 2005) | X | X | - | X | . | - | - | - |
|-------------------------------|---|---|---|---|---|---|---|---|

SAAB



















|                              |   |   |   |   |   |   |   |   |
|------------------------------|---|---|---|---|---|---|---|---|
| 93 Sport Wagon (2005 - 2012) | X | . | X | . | . | - | - | - |
| New 95 (2011 - 2012)         | X | . | X | . | . | - | - | - |

SEAT

|  |   |   |   |   |   |   |   |   |
|--|---|---|---|---|---|---|---|---|
| <b>SB!</b> Alhambra (2010 >)   | X | . | . | . | . | X | - | X |
|  Altea (2004 - 2012)    | X | . | X | . | . | - | - | - |
|  Arona (2021 >)         | X | . | X | . | . | - | - | - |
|  Arosa (1997 - 2004)    | X | X | - | X | . | - | - | - |
|  Ateca 2018 (2018 >)    | X | . | X | . | . | - | - | - |
|  Cupra Born EV (2022 >) | X | . | X | . | . | - | - | - |
|  Exeo ST (2008 >)       | X | . | X | . | . | - | - | - |
|  Ibiza 2018 (2018 >)    | X | . | X | . | . | - | - | - |
| Ibiza HATCH 5 door (2008 - 2013)   | X | X | X | X | . | - | - | - |
| Leon FR (2006 - 2012)  | X | . | X | . | . | - | - | - |
| Leon (2000 - 2005)   | X | . | X | . | . | - | - | - |
| New Toledo (2013 >)  | X | . | X | . | . | - | - | - |
| mii 5dr (2011 >)   | X | X | X | X | . | - | - | - |
| Leon 2013 (2013 >)   | X | . | X | . | . | - | - | - |

① ② ③ ④ ⑤ ⑥ ⑦

Skoda

|  |   |   |   |   |   |   |   |   |
|--|---|---|---|---|---|---|---|---|
|  Citigo 5dr (2011 >)          | X | X | X | X | . | - | - | - |
|  Citigo 5dr (2012 >)          | X | X | - | X | . | - | - | - |
|  Enyaq EV (2021 >)            | X | . | X | . | . | - | - | - |
|  Fabia 2015 (2015 >)          | X | X | X | X | . | - | - | - |
|  Fabia 2021 (2021 >)          | X | . | X | . | . | - | - | - |
|  Fabia Hatch (2007 >)         | X | X | X | X | . | - | - | - |
|  Kamiq (2021 >)               | X | . | X | . | . | - | - | - |
|  Karoq 2017 > (2017 >)        | X | . | X | . | . | - | - | - |
|  Kodiaq 2017 > (2017 >)       | X | . | X | . | X | X | - | X |
|  Octavia (2004 - 2012)        | X | . | X | . | . | - | - | - |
|  Octavia 2020 (2020 >)        | X | . | X | . | . | - | - | - |
|  Octavia Hatch 2013 (2013 >)  | X | . | X | . | . | - | - | - |
|  Rapid (2013 >)               | X | . | X | . | . | - | - | - |
|  Roomster (2006 >)            | X | . | X | . | . | - | - | - |
|  Scala (2022 >)               | X | . | X | . | . | - | - | - |
|  Superb 2015 (2015 >)         | X | . | X | . | . | - | - | - |
|  Superb Combi/Estate (2008 >) | X | . | X | . | . | - | - | - |
|  Yeti (2009 >)                | X | . | X | . | . | - | - | - |

Smart

|                                  |   |   |   |   |   |   |   |   |
|----------------------------------|---|---|---|---|---|---|---|---|
| For Two Coupe (2007 - 2011)      | X | - | - | - | - | - | - | - |
| For Two Coupe 2015 (2015 - 2019) | X | - | - | - | - | - | - | - |
| FourFour 2015 (2015 >)           | X | X | - | X | . | - | - | - |

Ssangyong

|                            |   |   |   |   |   |   |   |   |
|----------------------------|---|---|---|---|---|---|---|---|
| Actyon (2006 - 2011)       | X | . | X | . | . | - | - | - |
| Korando (2011 >)           | X | . | X | . | . | - | - | - |
| Musso Pickup 2016 (2016 >) | X | . | . | . | . | - | - | - |
| Rexton (2014 - 2016)       | X | . | X | . | . | - | - | - |
| Tivoli (2015 >)            | X | . | X | . | . | - | - | - |
| Turismo (2014 >)           | X | . | . | - | . | X | X | X |







Subaru

|                      |   |   |   |   |   |   |   |   |
|----------------------|---|---|---|---|---|---|---|---|
| BRZ (2012 >)         | X | X | - | X | . | - | - | - |
| Forester (2013 >)    | X | . | X | . | . | - | - | - |
| Impreza 5dr (2007 >) | X | . | X | . | . | - | - | - |

① ② ③ ④ ⑤ ⑥ ⑦

|  |   |   |   |   |   |   |   |
|--|---|---|---|---|---|---|---|
| Impreza Hatchback 2013 (2013 >)  | X | • | X | • | - | - | - |
| Legacy (2012 >)  | X | • | X | • | - | - | - |
|  Levorg 2014 (2014 >) | X | • | X | • | - | - | - |
| Outback (2012 >)   | X | • | X | • | - | - | - |
| XV Hatchback (2011 >)  | X | • | X | • | - | - | - |





Suzuki

|   |   |   |   |   |   |   |   |
|---|---|---|---|---|---|---|---|
|  Across (2020 >)           | X | • | X | • | - | - | - |
| Alto (2009 >)   | X | X | - | X | - | - | - |
|  Baleno 2016 (2016 >)      | X | • | X | • | - | - | - |
|  Celerio 2016 5dr (2015 >) | X | • | X | • | - | - | - |
|  Grand Vitara (2005 >)     | X | • | X | • | - | - | - |
|  Ignis 2016 (2016 >)       | X | • | - | • | - | - | - |
| SX-4 5dr (2006 >)   | X | • | X | • | - | - | - |
| Splash (2008 >)   | X | X | X | X | - | - | - |
|  Swift 2017 (2017 >)       | X | • | X | • | - | - | - |
| Swift Sport 5dr (2011 >)  | X | X | X | X | - | - | - |
| Vitara 2015 (2015 >)  | X | • | X | • | - | - | - |











Tesla

|  |   |   |   |   |   |   |   |
|--|---|---|---|---|---|---|---|
|  Model 3 (2017 >) | X | • | X | • | - | - | - |
|  Model 3 (2019 >) | X | • | X | • | - | - | - |
| Model S (2012 >)   | X | • | X | • | - | - | - |
| Model X (2015 >)   | X | • | - | • | - | - | • |
|  Model Y (2022 >) | X | • | X | • | - | - | - |





Toyota

|  |   |   |   |   |   |   |   |
|--|---|---|---|---|---|---|---|
| <b>SB!</b> 2013 Verso (2013 >)   | X | • | X | • | - | - | - |
| Auris (2007 - 2013)  | X | • | X | • | - | - | - |
| Auris (2013 >)   | X | • | X | • | - | - | - |
| Avensis Hatch (2003 - 2011)  | X | • | X | • | - | - | - |
|  Aygo 2014 (2014 >)     | X | X | - | X | - | - | - |
| Aygo 2019 (2019 >)   | X | • | - | • | - | - | - |
| Aygo 3dr (2005 >)  | X | X | - | X | - | - | - |
|  Aygo X 2021 (2021 >)   | X | • | X | • | - | - | - |
|  C-HR (2017 >)         | X | • | X | • | - | - | - |
|  Corolla 2018 (2018 >) | X | • | X | • | - | - | - |
| EZ Mpv (2013 >)  | X | • | X | • | - | - | - |

① ② ③ ④ ⑤ ⑥ ⑦

|   |   |   |   |   |   |   |   |
|---|---|---|---|---|---|---|---|
| GT86 (2012 >)   | X | X | - | X | - | - | - |
|  Highlander (2013 >)       | X | • | X | • | - | - | - |
|  Highlander 2021 (2021 >)  | X | • | X | • | - | - | - |
| Land Cruiser (2003 - 2009)  | X | • | X | • | - | - | - |
| Landcruiser (2009 >)  | X | • | X | • | - | - | - |
| Prius 2 (2004 - 2009)   | X | • | X | • | - | - | - |
| Prius 3 (2010 >)  | X | • | X | • | - | - | - |
|  Prius 4 (2016) (2015 >)   | X | • | X | • | - | - | - |
| Prius PHEV 3 (2015 >)   | X | • | X | • | - | - | - |
| Prius Plus+ (2012 >)  | X | • | X | • | - | - | - |
| RAV 4 (2006 - 2012)   | X | • | X | • | - | - | - |
|  RAV4 (2013 >)             | X | • | X | • | - | - | - |
|  RAV4 2019 (2019 >)        | X | • | X | • | - | - | - |
|  RAV4 Hybrid (2015 >)      | X | • | X | • | - | - | - |
|  RAV4 Hybrid (2015 >)      | X | • | X | • | - | - | - |
| <b>SB!</b> Verso (2009 - 2012)  | X | • | X | • | - | - | - |
|  Yaris 2017 > (2017 >)     | X | • | X | • | - | - | - |
|  Yaris 2019 (2019 >)       | X | • | X | • | - | - | - |
|  Yaris Cross 2022 (2022 >) | X | • | X | • | - | - | - |
| Yaris Hatch (2011 >)  | X | X | X | X | - | - | - |
| Yaris Hatch 5dr (2006 - 2011)   | X | X | X | X | - | - | - |

VW

|  |   |   |   |   |   |   |   |
|--|---|---|---|---|---|---|---|
| Amarok Double-Cab (2022 >)   | X | • | X | • | - | - | - |
|  Arteon 2017 > (2017 >) | X | • | X | • | - | - | - |
| Beetle (2012 >)  | X | • | - | - | - | - | - |
| Beetle 1999 (1999 - 2005)  | X | X | - | X | - | - | - |
| <b>SB!</b> Caddy Maxilife (2010 >)   | X | • | X | • | X | - | X |
| E-Golf Hatch Mk7 (2015 >)  | X | • | X | • | - | - | - |
| E-UP! 5dr (2015 >)   | X | X | X | X | - | - | - |
| Golf Cabriolet (2009 >)  | X | X | - | X | - | - | - |
| Golf GTE Hatch Mk7 (2015 >)  | X | • | X | • | - | - | - |
| Golf Hatch (2009 - 2013)   | X | • | X | • | - | - | - |
| Golf Hatch Mk5 (2004 - 2008)   | X | • | X | • | - | - | - |
| Golf Hatch Mk7 (2012 >)  | X | • | X | • | - | - | - |
| Golf Plus (2009 - 2013)  | X | • | X | • | - | - | - |
|  ID3 EV (2020 >)        | X | • | X | • | - | - | - |
|  ID4 EV (2021 >)       | X | • | X | • | - | - | - |
|  ID5 EV (2022 >)       | X | • | X | • | - | - | - |
| Jetta (2011 >)   | X | • | X | • | - | - | - |

① ② ③ ④ ⑤ ⑥ ⑦

|  |                                 |   |   |   |   |   |   |   |   |
|--|---------------------------------|---|---|---|---|---|---|---|---|
|  | Lupo (1999 - 2005)              | X | X | - | X | - | - | - | - |
|  | Multivan Caravelle (2008 >)     | X | . | . | . | . | X | . | . |
|  | Passat CC (2008 >)              | X | . | X | . | . | - | - | - |
|  | Passat Estate (2005 - 2011)     | X | . | X | . | . | - | - | - |
|  | Passat Estate (2011-2015)       | X | . | X | . | . | - | - | - |
|  | Passat Estate 2015 (2015 >)     | X | . | X | . | . | - | - | - |
|  | Passat Saloon (2005 - 2011)     | X | . | X | . | . | - | - | - |
|  | Passat Saloon (2011-2015)       | X | . | X | . | . | - | - | - |
|  | Passat Saloon 2015 (2015 >)     | X | . | X | . | . | - | - | - |
|  | Polo 2017 (2017 >)              | X | . | X | . | . | - | - | - |
|  | Polo 3dr (2009 >)               | X | X | X | X | . | - | - | - |
|  | Polo 5dr (2009 >)               | X | X | X | X | . | - | - | - |
|  | Scirocco (2011 >)               | X | . | . | . | . | - | - | - |
|  | <b>SB!</b> Sharan (2010 >)      | X | . | . | . | X | - | X | - |
|  | T-Cross (2019 >)                | X | . | X | . | . | - | - | - |
|  | T-Roc (2017 >)                  | X | . | X | . | . | - | - | - |
|  | Taigo (2022 >)                  | X | . | X | . | . | - | - | - |
|  | Tiguan (2008 >)                 | X | . | X | . | . | - | - | - |
|  | Tiguan 2016 (2016 >)            | X | . | X | . | . | - | - | - |
|  | Tiguan Allspace 2017 > (2017 >) | X | . | X | . | X | - | X | - |
|  | Touareg (2012 >)                | X | . | X | . | . | - | - | - |
|  | Touareg (2003 - 2010)           | X | . | X | . | . | - | - | - |
|  | Touareg 2018 (2018 >)           | X | . | X | . | . | - | - | - |
|  | Touran 2016 (2016 >)            | X | . | . | . | X | - | X | - |
|  | <b>SB!</b> Touran (2010 >)      | X | . | X | . | X | - | X | - |
|  | UP! 5dr (2015 >)                | X | X | X | X | . | - | - | - |

Vauxhall

|  |                            |   |   |   |   |   |   |   |   |
|--|----------------------------|---|---|---|---|---|---|---|---|
|  | Adam (2013 >)              | X | . | . | . | - | - | - | - |
|  | Agila (2008 >)             | X | . | X | . | . | - | - | - |
|  | Ampera (2011 >)            | X | . | . | . | . | - | - | - |
|  | Antara (2007 >)            | X | . | X | . | . | - | - | - |
|  | Astra 2010 5dr (2010 >)    | X | . | X | . | . | - | - | - |
|  | Astra 2015 (2015 >)        | X | . | X | . | . | - | - | - |
|  | Astra GTC (2011 >)         | X | . | X | . | . | - | - | - |
|  | Astra Saloon (1998 - 2004) | X | X | X | X | . | - | - | - |
|  | Corsa 5dr 2015 (2015 >)    | X | . | X | . | . | - | - | - |
|  | Corsa Hatch 5dr (2006 >)   | X | . | X | . | . | - | - | - |
|  | Insignia Hatch (2009 >)    | X | . | X | . | . | - | - | - |
|  | Meriva (2010 >)            | X | . | X | . | . | - | - | - |

① ② ③ ④ ⑤ ⑥ ⑦

|  |                              |   |   |   |   |   |   |   |   |
|--|------------------------------|---|---|---|---|---|---|---|---|
|  | Mokka (2013 >)               | X | . | X | . | . | - | - | - |
|  | Vectra 2005 (2005 - 2008)    | X | . | X | . | . | - | - | - |
|  | Viva (2015 >)                | X | X | X | X | . | - | - | - |
|  | Zafira (2005 >)              | X | . | X | . | . | - | - | - |
|  | Zafira Tourer (2012 >)       | X | . | X | . | . | - | - | - |
|  | Zafira Tourer (2012 >)       | X | . | X | . | X | - | X | - |
|  | /Opel Crossland X (2018 >)   | X | . | X | . | . | - | - | - |
|  | /Opel Grandland X (2019 >)   | X | . | X | . | . | - | - | - |
|  | /Opel Insignia 2018 (2018 >) | X | . | X | . | . | - | - | - |

Volvo

|  |                           |   |   |   |   |   |   |   |   |
|--|---------------------------|---|---|---|---|---|---|---|---|
|  | C30 (2007 - 2013)         | X | . | . | . | - | - | - | - |
|  | S40 (2004 - 2012)         | X | . | X | . | . | - | - | - |
|  | S90 2016 (2016 >)         | X | . | X | . | . | - | - | - |
|  | V40 (2013 >)              | X | . | X | . | . | - | - | - |
|  | V40 Cross County (2013 >) | X | . | X | . | . | - | - | - |
|  | V50 (2004 - 2012)         | X | . | X | . | . | - | - | - |
|  | V60 (2011 >)              | X | . | X | . | . | - | - | - |
|  | V60 Plug-In (2015 >)      | X | . | X | . | . | - | - | - |
|  | V60 (2018 >)              | X | . | X | . | . | - | - | - |
|  | V90 2016 (2016 >)         | X | . | X | . | . | - | - | - |
|  | XC40 (2018 >)             | X | . | X | . | . | - | - | - |
|  | XC60 (2013 >)             | X | . | X | . | . | - | - | - |
|  | XC60 2017 (2017 >)        | X | . | X | . | . | - | - | - |
|  | XC70 (2008 >)             | X | . | X | . | . | - | - | - |
|  | XC90 (2003 - 2015)        | X | . | X | . | . | - | - | - |
|  | XC90 2016 (2016 >)        | X | . | X | . | X | - | X | - |

## 76-105cms FF with SIP

① ② ③ ④ ⑤ ⑥ ⑦







### Alfa Romeo

|   |                    |   |   |   |   |   |   |   |   |
|---|--------------------|---|---|---|---|---|---|---|---|
|  | 4C Coupe (2014 >)  | X | - | - | - | - | - | - | - |
|   | Giulia (2017 >)    | X | • | X | • | - | - | - | - |
|   | Giulietta (2010 >) | X | X | X | X | - | - | - | - |
|   | MiTo 3dr (2009 >)  | X | • | - | • | - | - | - | - |
|  | Stelvio (2017 >)   | X | • | X | • | - | - | - | - |





### Aston Martin

|  |                  |   |   |   |   |   |   |   |   |
|--|------------------|---|---|---|---|---|---|---|---|
|  | DB11 (2019 >)    | X | X | - | X | - | - | - | - |
|  | DBS (2019 >)     | X | X | - | X | - | - | - | - |
|  | Vantage (2019 >) | X | - | - | - | - | - | - | - |



### Audi

|  |                               |   |   |   |   |   |   |   |   |
|--|-------------------------------|---|---|---|---|---|---|---|---|
|   | A1 2018 5dr (2018 >)          | X | • | X | • | - | - | - | - |
|  | A1 Sportback 5dr (2012 >)     | X | • | X | • | - | - | - | - |
|  | A3 2004 5dr (2005 - 2011)     | X | • | X | • | - | - | - | - |
|  | A3 3dr (1996 - 2003)          | X | X | X | X | - | - | - | - |
|  | A3 Hatch 5dr (2012 >)         | X | • | X | • | - | - | - | - |
|  | A3 S3 5dr (2012 >)            | X | • | X | • | - | - | - | - |
|  | A3 Saloon (2014 >)            | X | • | X | • | - | - | - | - |
|  | A3 e-Tron Sportback (2015 >)  | X | • | X | • | - | - | - | - |
|  | A4 2005 (2005 - 2008)         | X | • | X | • | - | - | - | - |
|   | A4 2015 (2015 >)              | X | • | X | • | - | - | - | - |
|  | A4 Avant (2008 >)             | X | • | X | • | - | - | - | - |
|  | A5 Sportback (2009 >)         | X | • | X | • | - | - | - | - |
|   | A5/S5 Cabriolet 2017 (2017 >) | X | X | - | X | - | - | - | - |
|  | A5/S5 Coupe 2016 (2016 >)     | X | X | - | X | - | - | - | - |
|   | A5/S5 Sportback 2017 (2017 >) | X | • | X | • | - | - | - | - |
|  | A6 Allroad (2011 >)           | X | • | X | • | - | - | - | - |
|  | A6 Avant (2011 >)             | X | • | X | • | - | - | - | - |
|  | A7 Sportback (2011 >)         | X | • | X | • | - | - | - | - |
|  | A7/S7 Sportback (2016 >)      | X | • | X | • | - | - | - | - |
|  | A7/S7 Sportback 2018 (2018 >) | X | • | X | • | - | - | - | - |
|  | A8 (2011 >)                   | X | • | X | • | - | - | - | - |
|  | A8 S8 (2011 >)                | X | • | X | • | - | - | - | - |
|   | A8/S8 2018 (2018 >)           | X | • | X | • | - | - | - | - |
|  | Q2 (2016 >)                   | X | • | X | • | - | - | - | - |
|  | Q3 (2011 >)                   | X | • | X | • | - | - | - | - |

① ② ③ ④ ⑤ ⑥ ⑦

|   |   |                      |   |   |   |   |   |   |   |
|---|---|----------------------|---|---|---|---|---|---|---|
|  |   | Q3 (2019 >)          | X | • | X | • | - | - | - |
|   |   | Q4 e-Tron (2021 >)   | X | • | X | • | - | - | - |
|   |   | Q5 (2009 >)          | X | X | X | X | - | - | - |
|   |   | Q5/SQ5 2017 (2017 >) | X | • | X | • | - | - | - |
|   |   | Q7 (2006 >)          | X | X | X | X | - | - | - |
|  |  | Q7 2015 (2015 >)     | X | • | X | • | X | - | X |
|   |   | Q8 (2018 >)          | X | • | X | • | - | - | - |
|   |   | TT Coupe (2008 >)    | X | X | - | X | - | - | - |



### BMW







|   |                                    |   |   |   |   |   |   |   |   |
|---|------------------------------------|---|---|---|---|---|---|---|---|
|   | 1 Series (f20) 5dr (2011 >)        | X | • | X | • | - | - | - | - |
|   | 1-Series 5dr (2004 - 2010)         | X | • | X | • | - | - | - | - |
|   | 1-Series Cabrio (2008 >)           | X | • | - | - | - | - | - | - |
|   | 1-Series Coupe (2008 >)            | X | • | - | - | - | - | - | - |
|   | 2-Series AC-T (2015 >)             | X | • | X | • | - | - | - | - |
|   | 2-Series Coupe (2014 >)            | X | • | - | - | - | - | - | - |
|   | 3 Series (f30) (2012 >)            | X | • | X | • | - | - | - | - |
|   | 3-Series (E46) Coupe (2002 - 2006) | X | X | X | X | - | - | - | - |
|   | 3-Series Coupe (E90) (2007 >)      | X | • | - | • | - | - | - | - |
|   | 3GT (2013 >)                       | X | • | X | • | - | - | - | - |
|   | 4-Series Gran Coupe (2014 >)       | X | X | X | X | - | - | - | - |
|   | 5-GT (2010 >)                      | X | • | X | • | - | - | - | - |
|   | 5-Series (F10) (2011 >)            | X | • | X | • | - | - | - | - |
|   | 5-Series (E60) (2003 - 2010)       | X | • | X | • | - | - | - | - |
|  | 5-Series 2018 (2018 >)             | X | • | X | • | - | - | - | - |
|   | 6-Series Cabrio (2011 >)           | X | X | - | X | - | - | - | - |
|   | 6-Series Coupe (2Dr) (2011 >)      | X | X | - | X | - | - | - | - |
|   | 6-Series Gran Coupe (4Dr) (2011 >) | X | • | X | • | - | - | - | - |
|   | 7-Series (2010 >)                  | X | • | X | • | - | - | - | - |
|   | 7-Series 2015 (2015 >)             | X | • | X | • | - | - | - | - |
|   | X1 (2009 - 2015)                   | X | • | X | • | - | - | - | - |
|  | X1 2016 (2016 >)                   | X | • | X | • | - | - | - | - |
|   | X3 (F25) (2011 >)                  | X | • | X | • | - | - | - | - |
|  | X3 2018 (2018 >)                   | X | • | X | • | - | - | - | - |
|   | X4 (2014 >)                        | X | • | X | • | - | - | - | - |
|   | X5 2000 (2000 - 2006)              | X | X | X | X | - | - | - | - |
|   | X5 2007 (2007 - 2014)              | X | X | X | X | X | - | X | - |
|   | X5 2015 (2015 >)                   | X | • | X | • | X | - | X | - |
|   | X6 (2009 >)                        | X | • | X | • | - | - | - | - |
|   | X6 2015 (2015 >)                   | X | • | - | • | - | - | - | - |



① ② ③ ④ ⑤ ⑥ ⑦

① ② ③ ④ ⑤ ⑥ ⑦

|                  |   |   |   |   |   |   |   |   |   |
|------------------|---|---|---|---|---|---|---|---|---|
|                  |   | i3 (2014 >)                             | X | . | . | . | - | - | - |
|                  |  | i8 (2014 >)                             | X | X | . | X | - | - | - |
|                  |   | iX (2021 >)                             | X | . | X | . | - | - | - |
|                  |  | iX3 (2022 >)                            | X | . | X | . | - | - | - |
| <b>Bentley</b>   |   | Continental Flying Spur (2005 >)        | X | . | X | . | - | - | - |
|                  |   | Continental GT (2003 - 2012)            | X | X | . | X | - | - | - |
|                  |   | Continental GT Conv (2006 - 2012)       | X | X | . | X | - | - | - |
|                  |   | Mulsanne (2012 >)                       | X | . | X | . | - | - | - |
| <b>Cadillac</b>  |   | BLS (2005 - 2012)                       | X | . | X | . | - | - | - |
| <b>Chevrolet</b> |   | Aveo 5dr (2012 >)                       | X | . | X | . | - | - | - |
|                  |   | Captiva (2010 >)                        | X | . | X | . | - | - | - |
|                  |   | Cruze (2011 >)                          | X | . | X | . | - | - | - |
|                  |   | Orland (2011 >)                         | X | . | X | . | - | - | - |
|                  |   | Spark 5dr (2012 >)                      | X | X | . | X | - | - | - |
|                  |   | Traxx (2013 >)                          | X | . | X | . | - | - | - |
|                  |   | Volt (2011 >)                           | X | . | . | . | - | - | - |
| <b>Chrysler</b>  |   | 300C (2012 >)                           | X | . | X | . | - | - | - |
|                  |   | Delta (2007 >)                          | X | . | X | . | - | - | - |
|                  |   | Grand Voyager (2008 >)                  | X | . | . | . | X | X | X |
|                  |   | Ypsilon 3dr (2012 >)                    | X | . | X | . | - | - | - |
| <b>Citroen</b>   |   | <b>SB!</b> Berlingo II (2008 >)         | X | . | X | . | - | - | - |
|                  |   | <b>SB!</b> Berlingo Multispace (2007 >) | X | X | X | X | X | - | X |
|                  |  | C-Cactus (2015)                         | X | . | X | . | - | - | - |
|                  |   | C1 2015 5dr (2015 >)                    | X | . | . | . | - | - | - |
|                  |   | C1 3dr (2006 >)                         | X | . | . | . | - | - | - |
|                  |   | C3 5Dr (2009 >)                         | X | . | X | . | - | - | - |

|              |   |  |   |   |   |   |   |   |   |
|--------------|---|--|---|---|---|---|---|---|---|
|              |   | C3 5dr 2005 (2005 - 2009)              | X | . | X | . | - | - | - |
|              |  | C3 5dr 2016 (2016 >)                   | X | . | X | . | - | - | - |
|              |   | C3 Aircross (2017 >)                   | X | . | X | . | - | - | - |
|              |   | <b>SB!</b> C3 Picasso (2009 >)         | X | . | X | . | - | - | - |
|              | <b>SB!</b>  | C4 G-Picasso 2007 (2007 - 2013)        | X | X | . | X | X | - | X |
|              |   | <b>SB!</b> C4 G-Picasso (2014 >)       | X | X | . | X | X | - | X |
|              |   | <b>SB!</b> C4 Picasso (2007 - 2013)    | X | X | . | X | X | - | - |
|              |   | C5 (2008 >)                            | X | X | . | X | X | - | - |
|              |   | C5 2005 (2005 - 2008)                  | X | X | . | X | X | - | - |
|              |  | C5 Aircross (2019 >)                   | X | X | . | X | X | - | - |
|              |   | C5 Tourer (2009 >)                     | X | X | . | X | X | - | - |
|              |   | DS3 (2011 >)                           | X | X | . | X | X | - | - |
|              |   | DS3 Cabrio (2013 >)                    | X | . | X | . | - | - | - |
|              |  | DS3 Crossback (2019 >)                 | X | . | X | . | - | - | - |
|              |   | DS4 (2011 >)                           | X | . | X | . | - | - | - |
|              |   | DS5 (2013 >)                           | X | . | X | . | - | - | - |
|              |  | DS7 (2018 >)                           | X | . | X | . | - | - | - |
|              |   | Jumpy (2007 - 2016)                    | X | . | X | . | X | - | X |
|              |   | Nemo (2008 >)                          | X | . | X | . | - | - | - |
|              |   | Xsara 5dr (2000 - 2004)                | X | X | . | X | X | - | - |
|              |   | <b>SB!</b> Xsara Picasso (2000 - 2012) | X | X | . | X | X | - | - |
| <b>Dacia</b> |   | Duster (2012 >)                        | X | . | X | . | - | - | - |
|              |  | Jogger (2022 >)                        | X | X | . | X | X | - | - |
|              |   | Logan MCV (2013 >)                     | X | X | . | X | X | - | - |
|              |   | Logan MCV 2006 (2008/11-2013/7)        | X | X | . | X | X | - | - |
|              |   | Sandero (2013 >)                       | X | X | . | X | X | - | - |
| <b>FIAT</b>  |   | 124 Spider 2016 (2016 >)               | X | . | . | . | - | - | - |
|              |   | 500 (2008 >)                           | X | . | . | . | - | - | - |
|              |   | 500L (2013 >)                          | X | . | X | . | - | - | - |
|              |  | 500X (2015 >)                          | X | . | X | . | - | - | - |
|              |   | Bravo (2007 >)                         | X | . | X | . | - | - | - |
|              |   | Doblo (2007 >)                         | X | . | X | . | - | - | - |
|              |   | Panda (2012 >)                         | X | . | X | . | - | - | - |
|              |   | Punto 3dr (Grande Punto) (2006 >)      | X | . | X | . | - | - | - |
|              |   | Qubo (2008 >)                          | X | . | X | . | - | - | - |



Tipo 2016 (2016 >) X • X • - - -

Ford

|  |                                   |                          |   |   |   |   |   |   |
|--|-----------------------------------|--------------------------|---|---|---|---|---|---|
|  | Galaxy 2016 (2016 >)              | X                        | X | X | X | X | - | X |
|  | B-Max (2012 >)                    | X                        | • | X | • | - | - | - |
|  | C-Max 2013 (2011 >)               | X                        | X | X | X | - | - | - |
|  | <b>SB!</b> C-Max (2003 - 2013)    | X                        | X | X | X | - | - | - |
|  | EcoSport (2015 >)                 | X                        | • | X | • | - | - | - |
|  | <b>SB!</b> Edge (2016 >)          | X                        | X | • | X | - | X |   |
|  | Fiesta 2004 3dr (2004 - 2008)     | X                        | X | X | X | - | - | - |
|  | Fiesta 2008 5dr (2008 >)          | X                        | • | X | • | - | - | - |
|  | Fiesta 2017 > (2017 >)            | X                        | • | X | • | - | - | - |
|  | Focus (2010 >)                    | X                        | • | X | • | - | - | - |
|  | Focus 2005 (2005 - 2009)          | X                        | X | X | X | - | - | - |
|  | Focus 2018 (2018 >)               | X                        | • | X | • | - | - | - |
|  | Focus EV (2015 >)                 | X                        | X | X | - | - | - | - |
|  | Focus Mk1 (1998 - 2004)           | X                        | X | X | X | - | - | - |
|  | Galaxy (2006 >)                   | X                        | X | X | X | X | - | X |
|  | Ka 3dr (2009 - 2013)              | X                        | • | - | • | - | - | - |
|  | Ka+ 2016 5dr (2016 >)             | X                        | X | X | - | - | - | - |
|  | Kuga 2008 (2008 - 2012)           | X                        | X | X | X | - | - | - |
|  | Kuga 2013 (2013 >)                | X                        | • | X | • | - | - | - |
|  | Kuga 2017 (2017 >)                | X                        | • | X | • | - | - | - |
|  | Kuga 2020 (2020 >)                | X                        | • | X | • | - | - | - |
|  | Mondeo 2000 (2000 - 2007)         | X                        | X | X | X | - | - | - |
|  | Mondeo Estate (2007 >)            | X                        | • | X | • | - | - | - |
|  | Mustang Cabrio 2015 (2015 >)      | X                        | X | - | X | - | - | - |
|  | Mustang Coupe 2015 (2015 >)       | X                        | X | - | X | - | - | - |
|  |                                   | Mustang Mach E (2022 >)  | X | • | X | • | - | - |
|  |                                   | New Mondeo 2014 (2014 >) | X | • | X | • | - | - |
|  | Puma (2020 >)                     | X                        | • | X | • | - | - | - |
|  | Ranger Double-Cab Pickup (2019 >) | X                        | • | X | • | - | - | - |
|  | S-Max (2006 >)                    | X                        | X | X | X | X | - | X |
|  | S-Max 2015 (2015 >)               | X                        | X | X | X | X | - | X |

Genesis



G80 (2021 >) X • X • - - -



GV80 SUV (2021 >) X • X • - - -

Honda

|  |                             |                    |   |   |   |   |   |   |
|--|-----------------------------|--------------------|---|---|---|---|---|---|
|  | Accord Saloon (2008 >)      | X                  | • | X | • | - | - | - |
|  | CR-V (2007 - 2012)          | X                  | X | X | X | - | - | - |
|  | CR-V 2012 (2012 >)          | X                  | • | X | • | - | - | - |
|  | CR-V 2019 (2019 >)          | X                  | • | X | • | X | - | X |
|  | Civic (2012 >)              | X                  | • | X | • | - | - | - |
|  | Civic (2006 - 2011)         | X                  | • | X | • | - | - | - |
|  | Civic 2017 (2017 >)         | X                  | • | X | • | - | - | - |
|  | Civic Saloon 2019 (2019 >)  | X                  | • | X | • | - | - | - |
|  | Civic Tourer (2014 >)       | X                  | • | X | • | - | - | - |
|  | E (2021 >)                  | X                  | • | X | • | - | - | - |
|  | ElySION (2012 >)            | X                  | • | - | - | X | X | X |
|  | FRV (2006 - 2011)           | X                  | X | X | X | - | - | - |
|  | HR-V (2015 >)               | X                  | • | X | • | - | - | - |
|  | HR-V 2022 (2022 >)          | X                  | • | X | • | - | - | - |
|  | Insight (2009 >)            | X                  | X | X | X | - | - | - |
|  | Jazz (2008 - 2015)          | X                  | • | X | • | - | - | - |
|  | Jazz 2002 (2002 - 2008)     | X                  | X | X | X | - | - | - |
|  |                             | Jazz 2016 (2016 >) | X | • | X | • | - | - |
|  | Jazz 2020 (2020 >)          | X                  | • | X | • | - | - | - |
|  | Jazz Crosstar 2021 (2021 >) | X                  | • | X | • | - | - | - |
|  | Odyssey (2010 >)            | X                  | X | - | X | - | - | - |

Hyundai

|  |                             |   |   |   |   |   |   |   |
|--|-----------------------------|---|---|---|---|---|---|---|
|  | Genesis Sedan (2016 >)      | X | • | X | • | - | - | - |
|  | Getz 5dr (2005 - 2011)      | X | • | X | • | - | - | - |
|  | Ioniq Hybrid (2016 >)       | X | • | X | • | - | - | - |
|  | Ix20 (2011 >)               | X | • | X | • | - | - | - |
|  | Kona 2017 > (2017 >)        | X | X | X | X | - | - | - |
|  | Santa Fe (2012 >)           | X | • | X | • | X | - | X |
|  | Santa Fe 2007 (2007 - 2012) | X | • | X | • | X | - | X |
|  | Tucson 2015 (2015 >)        | X | • | X | • | - | - | - |
|  | Veloster (2012 >)           | X | • | - | - | - | - | - |
|  | i10 2014 5dr (2014 >)       | X | X | X | X | - | - | - |
|  | i10 5dr (2008 >)            | X | • | X | • | - | - | - |
|  | i20 2014 > (2014 >)         | X | • | X | • | - | - | - |
|  | i20 2015 (2015 >)           | X | • | X | • | - | - | - |
|  | i20 Hatch (2009 >)          | X | • | X | • | - | - | - |
|  | i30 Hatch (2012 >)          | X | • | X | • | - | - | - |





① ② ③ ④ ⑤ ⑥ ⑦

|   |                              |   |   |   |   |   |   |   |
|---|------------------------------|---|---|---|---|---|---|---|
|  | i30 Hatch 2015 (2015 - 2017) | X | • | X | • | - | - | - |
|   | i30 Hatch 2017 (2017 >)      | X | • | X | • | - | - | - |
|   | i40 (2011 >)                 | X | • | X | • | - | - | - |
|   | i800/H1 (2008 >)             | X | • | X | • | X | X | X |
|   | ix35 (2010 >)                | X | • | X | • | - | - | - |

Infiniti

|  |                   |   |   |   |   |   |   |   |
|--|-------------------|---|---|---|---|---|---|---|
|  | EX SUV (2009 >)   | X | • | X | • | - | - | - |
|  | FX SUV (2009 >)   | X | • | X | • | - | - | - |
|  | G Coupe (2009 >)  | X | X | - | X | - | - | - |
|  | G Saloon (2009 >) | X | • | X | • | - | - | - |
|  | M Saloon (2010 >) | X | • | X | • | - | - | - |

Jaguar

|   |                         |   |   |   |   |   |   |   |
|---|-------------------------|---|---|---|---|---|---|---|
|  | E-Pace (2018 >)         | X | • | X | • | - | - | - |
|  | F-Pace (2016 >)         | X | • | X | • | - | - | - |
|   | F-Type Coupe (2014 >)   | X | - | - | - | - | - | - |
|  | I-Pace (2018 >)         | X | • | X | • | - | - | - |
|   | X-Type (2001 - 2010)    | X | X | X | X | - | - | - |
|   | XE (2015 >)             | X | • | X | • | - | - | - |
|  | XF (2008 >)             | X | • | X | • | - | - | - |
|  | XF 2015 (2015 >)        | X | • | X | • | - | - | - |
|   | XF Estate 2015 (2015 >) | X | • | X | • | - | - | - |
|   | XF Sportbrake (2012 >)  | X | • | X | • | - | - | - |
|   | XJ (2010 >)             | X | • | X | • | - | - | - |
|   | XK Coupe (2006 >)       | X | X | - | X | - | - | - |











Jeep

|   |                         |   |   |   |   |   |   |   |
|---|-------------------------|---|---|---|---|---|---|---|
|   | Cherokee 2014 (2014 >)  | X | • | X | • | - | - | - |
|   | Compass (2011 >)        | X | • | X | • | - | - | - |
|  | Grand Cherokee (2011 >) | X | • | X | • | - | - | - |
|   | Renegade 2015 (2015 >)  | X | • | X | • | - | - | - |
|   | Wrangler 5Dr (2007 >)   | X | X | X | X | - | - | - |

Kia

|   |                    |   |   |   |   |   |   |   |
|---|--------------------|---|---|---|---|---|---|---|
|   | Ceed 2020 (2020 >) | X | • | X | • | - | - | - |
|  | EV6 (2022 >)       | X | • | X | • | - | - | - |

① ② ③ ④ ⑤ ⑥ ⑦

|   |                                |   |   |   |   |   |   |   |
|---|--------------------------------|---|---|---|---|---|---|---|
|   | Sorento 2015 (2015 >)          | X | • | X | • | X | - | X |
|  | Sorento 2020 (2020 >)          | X | • | X | • | X | - | X |
|   | Soul EV (2015 >)               | X | • | X | • | - | - | - |
|  | Soul EV 2019 (2019 >)          | X | • | X | • | - | - | - |
|  | XCeed (2020 >)                 | X | • | X | • | - | - | - |
| <b>SBI</b>  | Carens 2013 (2013 >)           | X | X | X | X | X | - | X |
|   | Cee'D Hatch (2012 >)           | X | • | X | • | - | - | - |
|   | Cee'D Hatch (2012 >)           | X | • | X | • | - | - | - |
|  | Niro 2017 (2017 >)             | X | • | X | • | - | - | - |
|   | Niro Hybrid 2022 (2022 >)      | X | • | X | • | - | - | - |
|   | Optima (2011 >)                | X | • | X | • | - | - | - |
|  | Optima 2016 (2016 >)           | X | • | X | • | - | - | - |
|   | Picanto 2012 5dr (2011 - 2015) | X | • | X | • | - | - | - |
|  | Picanto 2017 > (2017 >)        | X | X | X | X | - | - | - |
|   | Picanto 5dr (2008 >)           | X | • | X | • | - | - | - |
|   | Rio (2012 >)                   | X | • | X | • | - | - | - |
|  | Rio 2017 > (2017 >)            | X | • | X | • | - | - | - |
|   | Sorento (2012 >)               | X | • | X | • | - | - | - |
|   | Sorento (2003 - 2009)          | X | • | X | • | - | - | - |
|   | Soul (2009 >)                  | X | • | X | • | - | - | - |
|   | Sportage (2011 >)              | X | • | X | • | - | - | - |
|  | Sportage 2016 (2016 >)         | X | • | X | • | - | - | - |
|  | Sportage 2022 (2022 >)         | X | • | X | • | - | - | - |
|  | Stonic 2017 > (2017 >)         | X | • | X | • | - | - | - |
|   | Venga (2011 >)                 | X | • | X | • | - | - | - |

Lancia

|  |                      |   |   |   |   |   |   |   |
|--|----------------------|---|---|---|---|---|---|---|
|  | Thema (2012 >)       | X | • | X | • | - | - | - |
|  | Voyager (2010 >)     | X | • | - | - | X | X | X |
|  | Ypsilon 3dr (2012 >) | X | • | X | • | - | - | - |

Land Rover

|   |                           |   |   |   |   |   |   |   |
|---|---------------------------|---|---|---|---|---|---|---|
|  | Defender 2020 (2020 >)    | X | • | X | • | X | - | X |
|   | Discovery 4 (2009 >)      | X | X | X | X | - | - | - |
|  | Discovery 5 2017 (2017 >) | X | • | X | • | X | - | X |
|   | Discovery Sport (2015 >)  | X | • | X | • | X | - | X |
|   | Freelander 2 (2006 >)     | X | • | X | • | - | - | - |
|   | Range Rover (2002 - 2012) | X | • | X | • | - | - | - |
|   | Range Rover 2013 (2013 >) | X | • | X | • | - | - | - |



|  |   |   |   |   |   |   |   |
|--|---|---|---|---|---|---|---|
| Range Rover Evoque (2011 >)            | X | X | X | X | - | - | - |
| Range Rover Evoque (5dr) 2019 (2019 >) | X | X | • | • | - | - | - |
| Range Rover Evoque 5 door (2011 >)     | X | • | X | • | - | - | - |
| Range Rover Sport (2005 - 2012)        | X | • | X | • | - | - | - |
| Range Rover Sport (2013 >)             | X | • | X | • | - | - | - |
| Range Rover VELAR (2017 >)             | X | • | X | • | - | - | - |

**Lexus**

|                        |   |   |   |   |   |   |   |
|------------------------|---|---|---|---|---|---|---|
| CT (2011 >)            | X | • | X | • | - | - | - |
| ES Hybrid (2019 >)     | X | • | X | • | - | - | - |
| GS (2013 >)            | X | • | X | • | - | - | - |
| IS (2005 >)            | X | • | X | • | - | - | - |
| IS 200 (2004) (1999 >) | X | • | X | • | - | - | - |
| NX (2014 >)            | X | • | X | • | - | - | - |
| RX (2010 >)            | X | • | X | • | - | - | - |
| RX 2016 (2017 >)       | X | • | X | • | - | - | - |
| UX (2019 >)            | X | • | X | • | - | - | - |

**MG**

|                      |   |   |   |   |   |   |   |
|----------------------|---|---|---|---|---|---|---|
| 5 EV Estate (2020 >) | X | • | X | • | - | - | - |
| GS (2016 >)          | X | • | X | • | - | - | - |
| HS PHEV SUV (2021 >) | X | • | X | • | - | - | - |
| HS SUV (2021 >)      | X | • | X | • | - | - | - |
| Motor MG6 (2012 >)   | X | • | X | • | - | - | - |
| ZS (2021 >)          | X | • | X | • | - | - | - |
| ZS EV (2021 >)       | X | • | X | • | - | - | - |

**MINI**

|                             |   |   |   |   |   |   |   |
|-----------------------------|---|---|---|---|---|---|---|
| Countryman (2010 >)         | X | • | X | • | - | - | - |
| Coupe (2009 >)              | X | - | - | - | - | - | - |
| Hatch (2006 >)              | X | X | - | X | - | - | - |
| Hatchback 3Dr 2014 (2014 >) | X | X | - | X | - | - | - |
| Hatchback 3dr (2000 - 2006) | X | X | - | X | - | - | - |
| Hatchback 5dr 2015 (2015 >) | X | • | X | • | - | - | - |
| Paceman (2013 >)            | X | X | - | X | - | - | - |

**Maserati**

|                            |   |   |   |   |   |   |   |
|----------------------------|---|---|---|---|---|---|---|
| Ghibli 2014 (2014 >)       | X | • | X | • | - | - | - |
| Gran Turismo 2007 (2007 >) | X | X | - | X | - | - | - |
| Levante (2017 >)           | X | • | X | • | - | - | - |
| Quattroporte 2016 (2016 >) | X | • | X | • | - | - | - |

**Mazda**

|                           |   |   |   |   |   |   |   |
|---------------------------|---|---|---|---|---|---|---|
| 2 (2007 >)                | X | • | X | • | - | - | - |
| 2 2015 5dr (2015 >)       | X | • | X | • | - | - | - |
| 3 Hatch (2009 - 2013)     | X | • | X | • | - | - | - |
| 3 Hatchback 2014 (2014 >) | X | • | X | • | - | - | - |
| 5 (2005 - 2010)           | X | • | X | • | - | - | - |
| 6 (2007 - 2012)           | X | • | X | • | - | - | - |
| 6 2018 (2018 >)           | X | • | X | • | - | - | - |
| 6 Estate (2013 >)         | X | • | X | • | - | - | - |
| 6 Saloon (2013 >)         | X | • | X | • | - | - | - |
| CX-3 (2015 >)             | X | • | X | • | - | - | - |
| CX-5 (2011 >)             | X | • | X | • | - | - | - |
| CX-7 (2007 >)             | X | • | X | • | - | - | - |
| MX-5 2015 (2016 >)        | X | - | - | - | - | - | - |

**Mercedes-Benz**

|                                 |   |   |   |   |   |   |   |
|---------------------------------|---|---|---|---|---|---|---|
| A Class (2005 - 2012)           | X | X | X | X | - | - | - |
| A-Class (2013 >)                | X | • | X | • | - | - | - |
| A-Class Hatchback 2019 (2019 >) | X | • | X | • | - | - | - |
| A-Class Saloon 2019 (2020 >)    | X | • | X | • | - | - | - |
| B-Class (2012 >)                | X | X | X | X | - | - | - |
| B-Class EV (2015 >)             | X | X | X | X | - | - | - |
| C-Class 2015 Estate (2015 >)    | X | X | X | X | - | - | - |
| C-Class Coupe (2011 >)          | X | X | - | X | - | - | - |
| C-Class Estate (2008 >)         | X | • | X | • | - | - | - |
| CLA (2013 >)                    | X | • | X | • | - | - | - |
| CLA 2019 (2020 >)               | X | • | X | • | - | - | - |
| CLA Shooting-Brake (2015 >)     | X | • | X | • | - | - | - |
| CLS Coupe (2011 >)              | X | • | X | • | - | - | - |
| CLS Shooting Brake (2012 >)     | X | • | X | • | - | - | - |
| E-Class 2006 (2006 - 2009)      | X | • | X | • | - | - | - |
| E-Class Cabriolet 2017 (2017 >) | X | • | - | • | - | - | - |

① ② ③ ④ ⑤ ⑥ ⑦

|  |                              |   |   |   |   |   |   |   |   |
|--|------------------------------|---|---|---|---|---|---|---|---|
|  | E-Class Coupe (2009 >)       | X | X | - | X | - | - | - | - |
|  | E-Class Coupe 2017 (2017 >)  | X | . | . | . | . | - | - | - |
|  | E-Class Estate (2013 >)      | X | . | X | . | . | - | - | - |
|  | E-Class Estate 2016 (2016 >) | X | . | X | . | . | - | - | - |
|  | E-Class Saloon 2013 (2013 >) | X | . | X | . | . | - | - | - |
|  | EQA 2021 (2021 >)            | X | . | X | . | . | - | - | - |
|  | EQC (2021 >)                 | X | . | X | . | . | - | - | - |
|  | GL Class (2012 >)            | X | . | X | . | X | - | X | - |
|  | GLA 2021 (2021 >)            | X | . | X | . | . | - | - | - |
|  | GLC (2016 >)                 | X | . | X | . | . | - | - | - |
|  | GLC Coupe (2019 >)           | X | . | X | . | . | - | - | - |
|  | GLE (2015 >)                 | X | . | X | . | . | - | - | - |
|  | GLE 2020 (2020 >)            | X | . | X | . | X | - | X | - |
|  | R-Class (2006 - 2012)        | X | . | X | . | X | - | - | - |
|  | S Class 2015 (2014 >)        | X | . | X | . | . | - | - | - |
|  | S-Class (2006 - 2013)        | X | . | X | . | . | - | - | - |
|  | SL-Class (2012 >)            | X | . | - | - | - | - | - | - |
|  | SLK (2012 >)                 | X | . | - | - | - | - | - | - |
|  | V-Class (2015 >)             | X | . | X | . | X | X | X | - |

Mini

|  |  |                          |   |   |   |   |   |   |   |
|--|--|--------------------------|---|---|---|---|---|---|---|
|  |  | Clubman 2016 (2016 >)    | X | X | X | X | - | - | - |
|  |  | Countryman 2017 (2017 >) | X | X | X | X | - | - | - |

Mitsubishi

|  |                                  |   |   |   |   |   |   |   |   |
|--|----------------------------------|---|---|---|---|---|---|---|---|
|  | ASX (2010 >)                     | X | . | X | . | . | - | - | - |
|  | Colt (2007 - 2013)               | X | . | X | . | . | - | - | - |
|  | Eclipse Cross (2019 >)           | X | . | X | . | . | - | - | - |
|  | Lancer (2008 - 2011 >)           | X | . | . | . | . | - | - | - |
|  | Lancer Sportback (2008 - 2011 >) | X | . | . | . | . | - | - | - |
|  | Mirage (2012 >)                  | X | . | X | X | X | - | - | - |
|  | Outlander (2007 - 2013)          | X | . | X | . | . | - | - | - |
|  | Outlander (2013 >)               | X | . | X | . | . | - | - | - |
|  | Outlander PHEV (2015 >)          | X | . | X | . | . | - | - | - |
|  | Shogun (2007 >)                  | X | . | X | . | . | - | - | - |

Nissan

|  |                       |   |   |   |   |   |   |   |   |
|--|-----------------------|---|---|---|---|---|---|---|---|
|  | 2008 X-Trail (2008 >) | X | . | X | . | . | - | - | - |
|--|-----------------------|---|---|---|---|---|---|---|---|

① ② ③ ④ ⑤ ⑥ ⑦

|  |                           |   |   |   |   |   |   |   |   |
|--|---------------------------|---|---|---|---|---|---|---|---|
|  | Juke (2010 >)             | X | X | X | X | - | - | - | - |
|  | Leaf EV (2010 - 2017)     | X | . | X | . | . | - | - | - |
|  | Micra 2017 > (2017 >)     | X | . | X | . | . | - | - | - |
|  | Micra 5dr (2011 >)        | X | . | X | . | . | - | - | - |
|  | Murano 2016 (2016 >)      | X | . | X | . | . | - | - | - |
|  | Navara 2015 > (2015 >)    | X | X | X | X | - | - | - | - |
|  | Note (2006 - 2013)        | X | . | X | . | . | - | - | - |
|  | Note 2014 (2014 >)        | X | . | X | . | . | - | - | - |
|  | Pulsar 2015 (2015 >)      | X | . | X | . | . | - | - | - |
|  | Qashqai 2007 (2006 -2013) | X | . | X | . | . | - | - | - |
|  | Qashqai 2014 (2014 >)     | X | . | X | . | . | - | - | - |
|  | Qashqai+2 (2008 >)        | X | . | X | . | . | - | - | - |
|  | Quest MPV (2012 >)        | X | . | - | - | - | X | X | X |
|  | X-Trail 2015 (2015 >)     | X | . | X | . | X | - | X | - |









Opel

|  |                              |   |   |   |   |   |   |   |   |
|--|------------------------------|---|---|---|---|---|---|---|---|
|  | Adam (2013 >)                | X | X | - | X | - | - | - | - |
|  | Agila (2008 >)               | X | . | X | . | . | - | - | - |
|  | Ampera (2011 >)              | X | . | - | . | . | - | - | - |
|  | Antara (2007 >)              | X | . | X | . | . | - | - | - |
|  | Astra 2003 5dr (2003 - 2009) | X | . | X | . | . | - | - | - |
|  | Astra 2010 5dr (2010 >)      | X | X | X | X | - | - | - | - |
|  | Astra 2015 (2015 >)          | X | . | X | . | . | - | - | - |
|  | Astra GTC (2011 >)           | X | . | X | . | . | - | - | - |
|  | Corso 5dr 2015 (2015 >)      | X | . | X | . | . | - | - | - |
|  | Corso Hatch 5dr (2006 >)     | X | . | X | . | . | - | - | - |
|  | Insignia Hatch (2009 >)      | X | . | X | . | . | - | - | - |
|  | Karl (2015 >)                | X | . | X | . | . | - | - | - |
|  | Meriva (2010 >)              | X | X | X | X | - | - | - | - |
|  | Mokka (2013 >)               | X | . | X | . | . | - | - | - |
|  | Vectra 2005 (2002 - 2008)    | X | . | X | . | . | - | - | - |
|  | Zafira (2005 >)              | X | X | X | X | - | - | - | - |
|  | Zafira Tourer (2012 >)       | X | X | X | X | X | - | X | - |

Peugeot

|  |                       |   |   |   |   |   |   |   |   |
|--|-----------------------|---|---|---|---|---|---|---|---|
|  | 107 3dr (2005 - 2013) | X | . | - | . | - | - | - | - |
|  | 108 5dr (2015 >)      | X | . | - | . | - | - | - | - |
|  | 2008 (2013 >)         | X | . | X | . | . | - | - | - |
|  | 2008 2020 (2020 >)    | X | . | X | . | . | - | - | - |

① ② ③ ④ ⑤ ⑥ ⑦

|   |   |   |   |   |   |   |   |
|---|---|---|---|---|---|---|---|
| 206 3dr (1998 - 2009)   | X | • | X | • | - | - | - |
| 207 3dr Hatchback (2006 - 2012)   | X | X | X | X | - | - | - |
| 207 5dr (2012 >)  | X | X | X | X | - | - | - |
|  208 2020 5dr (2020 >)   | X | • | X | • | - | - | - |
| 208 5dr (2012 >)  | X | • | X | • | - | - | - |
|  208 EV 2020 5dr (2020 >)  | X | • | X | • | - | - | - |
|  3008 2017 (2017 >)  | X | • | X | • | - | - | - |
| <b>SB!</b> 3008 (2009 >)  | X | • | X | • | - | - | - |
| 307 Hatchback (2001 - 2007)   | X | X | X | X | - | - | - |
| 308 (2014) (2014 >)   | X | • | X | • | - | - | - |
| 308 Hatchback (2007 >)  | X | X | X | X | - | - | - |
| 407 (2004 - 2011)   | X | • | X | • | - | - | - |
|  <b>SB!</b> 5008 (2011 >)  | X | X | • | X | X | - | X |
|  <b>SB!</b> 5008 (2018 >)  | X | X | • | X | X | - | X |
|  508 (2011 >)  | X | X | X | X | - | - | - |
|   508 2019 (2018 >) | X | • | X | • | - | - | - |
|  508 Estate PHEV 2019 (2019 >)   | X | • | X | • | - | - | - |
| Bipper Tepee (2008 >)   | X | • | X | • | - | - | - |
| Expert Tepee (2008 >)   | X | • | X | • | X | - | X |
| Partner Combi (2004 - 2010)   | X | X | X | X | - | - | - |
| <b>SB!</b> Partner Tepee (2008 >)   | X | • | X | • | - | - | - |
| RCZ (2011 >)  | X | X | - | X | - | - | - |
| Traveller 2016 (2016 >)   | X | • | • | • | • | • | • |

Polestar

|  |   |   |   |   |   |   |   |
|--|---|---|---|---|---|---|---|
|  2 (2021 >) | X | • | X | • | - | - | - |
|--|---|---|---|---|---|---|---|



Porsche

|   |   |   |   |   |   |   |   |
|---|---|---|---|---|---|---|---|
|  Cayenne (2011 >)          | X | • | X | • | - | - | - |
| Cayenne 2017 (2017 >)   | X | • | X | • | - | - | - |
|  Cayenne E-Hybrid (2015 >) | X | • | X | • | - | - | - |
| Macan (2014 >)  | X | • | X | • | - | - | - |
| Panamera (2011 >)   | X | • | - | - | - | - | - |
| Panamera E-Hybrid (2015 >)  | X | • | - | - | - | - | - |

Renault

|                        |   |   |   |   |   |   |   |
|------------------------|---|---|---|---|---|---|---|
| Captur (2015 >)        | X | • | X | • | - | - | - |
| Clio 5dr (2005 - 2013) | X | • | X | • | - | - | - |

① ② ③ ④ ⑤ ⑥ ⑦

|   |   |   |   |   |   |   |   |
|---|---|---|---|---|---|---|---|
| Clio 5dr 2013 (2013 >)  | X | X | X | X | - | - | - |
| Espace (2003 - 2012)  | X | X | • | X | X | - | X |
| Grand Espace (2003 - 2012)  | X | X | • | X | X | - | X |
| Kadjar (2015 >)   | X | • | X | • | - | - | - |
|  Koleos 2018 (2018 >)            | X | • | X | • | - | - | - |
| Laguna Sport Tourer (2008 - 2012)   | X | • | X | • | - | - | - |
|  Megane Hatch 2016 (2016 >)      | X | • | X | • | - | - | - |
| <b>SB!</b> Megane Hatch (2008 >)  | X | • | X | • | - | - | - |
| <b>SB!</b> Megane Hatch (2002 - 2009)   | X | • | X | • | - | - | - |
| Modus (2004 - 2012)   | X | • | X | • | - | - | - |
| <b>SB!</b> Scenic 2003 (2003 - 2009)  | X | X | X | X | - | - | - |
|  <b>SB!</b> Scenic 2017 (2017 >) | X | X | X | X | - | - | - |
| <b>SB!</b> Scenic (2009 >)  | X | X | X | X | - | - | - |
| Twingo 2015 (2015 >)  | X | • | - | - | - | - | - |
| Twingo 3dr (2007 >)   | X | X | - | X | - | - | - |







Rover

|                               |   |   |   |   |   |   |   |
|-------------------------------|---|---|---|---|---|---|---|
| 25 / Streetwise (1999 - 2005) | X | X | - | X | - | - | - |
|-------------------------------|---|---|---|---|---|---|---|

SAAB

|                              |   |   |   |   |   |   |   |
|------------------------------|---|---|---|---|---|---|---|
| 93 Sport Wagon (2005 - 2012) | X | • | X | • | - | - | - |
| New 95 (2011 - 2012)         | X | • | X | • | - | - | - |

SEAT

|  |   |   |   |   |   |   |   |
|--|---|---|---|---|---|---|---|
| <b>SB!</b> Alhambra (2010 >)   | X | X | • | X | X | - | X |
| Altea (2004 - 2012)  | X | • | X | • | - | - | - |
|  Arona (2021 >)         | X | • | X | • | - | - | - |
|  Arosa (1997 - 2004)    | X | • | - | - | - | - | - |
|  Ateca 2018 (2018 >)    | X | X | X | X | - | - | - |
|  Cupra Born EV (2022 >) | X | • | X | • | - | - | - |
|  Exeo ST (2008 >)       | X | • | X | • | - | - | - |
|  Ibiza 2018 (2018 >)    | X | • | X | • | - | - | - |
| Ibiza HATCH 5 door (2008 - 2013)   | X | • | X | • | - | - | - |
| Leon FR (2006 - 2012)  | X | • | X | • | - | - | - |
| Leon (2000 - 2005)   | X | X | X | X | - | - | - |
| New Toledo (2013 >)  | X | X | X | X | - | - | - |
| mii 5dr (2011 >)   | X | • | X | • | - | - | - |
| Leon 2013 (2013 >)   | X | • | X | • | - | - | - |

① ② ③ ④ ⑤ ⑥ ⑦

Skoda

|  |                              |   |   |   |   |   |   |   |   |
|--|------------------------------|---|---|---|---|---|---|---|---|
|  | Citigo 5dr (2011 >)          | X | • | X | • | - | - | - | - |
|  | Citigo 5dr (2012 >)          | X | • | - | • | - | - | - | - |
|  | Enyaq EV (2021 >)            | X | • | X | • | - | - | - | - |
|  | Fabia 2015 (2015 >)          | X | • | X | • | - | - | - | - |
|  | Fabia 2021 (2021 >)          | X | • | X | • | - | - | - | - |
|  | Fabia Hatch (2007 >)         | X | X | X | X | - | - | - | - |
|  | Kamiq (2021 >)               | X | • | X | • | - | - | - | - |
|  | Karoq 2017 > (2017 >)        | X | X | X | X | - | - | - | - |
|  | Kodiaq 2017 > (2017 >)       | X | • | X | • | X | - | X | - |
|  | Octavia (2004 - 2012)        | X | • | X | • | - | - | - | - |
|  | Octavia 2020 (2020 >)        | X | • | X | • | - | - | - | - |
|  | Octavia Hatch 2013 (2013 >)  | X | • | X | • | - | - | - | - |
|  | Rapid (2013 >)               | X | X | X | X | - | - | - | - |
|  | Roomster (2006 >)            | X | X | X | X | - | - | - | - |
|  | Scala (2022 >)               | X | • | X | • | - | - | - | - |
|  | Superb 2015 (2015 >)         | X | • | X | • | - | - | - | - |
|  | Superb Combi/Estate (2008 >) | X | • | X | • | - | - | - | - |
|  | Yeti (2009 >)                | X | X | X | X | - | - | - | - |

Smart

|  |                                  |   |   |   |   |   |   |   |   |
|--|----------------------------------|---|---|---|---|---|---|---|---|
|  | For Two Coupe (2007 - 2011)      | X | - | - | - | - | - | - | - |
|  | For Two Coupe 2015 (2015 - 2019) | X | - | - | - | - | - | - | - |
|  | FourFour 2015 (2015 >)           | X | • | - | • | - | - | - | - |

Ssangyong

|  |                            |   |   |   |   |   |   |   |   |
|--|----------------------------|---|---|---|---|---|---|---|---|
|  | Actyon (2006 - 2011)       | X | • | X | • | - | - | - | - |
|  | Korando (2011 >)           | X | • | X | • | - | - | - | - |
|  | Musso Pickup 2016 (2016 >) | X | • | - | • | - | - | - | - |
|  | Rexton (2014 - 2016)       | X | • | X | • | - | - | - | - |
|  | Tivoli (2015 >)            | X | • | X | • | - | - | - | - |
|  | Turismo (2014 >)           | X | • | - | • | X | X | X | - |

Subaru

|  |                      |   |   |   |   |   |   |   |   |
|--|----------------------|---|---|---|---|---|---|---|---|
|  | BRZ (2012 >)         | X | X | - | X | - | - | - | - |
|  | Forester (2013 >)    | X | • | X | • | - | - | - | - |
|  | Impreza 5dr (2007 >) | X | • | X | • | - | - | - | - |

① ② ③ ④ ⑤ ⑥ ⑦

|  |                                 |   |   |   |   |   |   |   |   |
|--|---------------------------------|---|---|---|---|---|---|---|---|
|  | Impreza Hatchback 2013 (2013 >) | X | • | X | • | - | - | - | - |
|  | Legacy (2012 >)                 | X | • | X | • | - | - | - | - |
|  | Levorg 2014 (2014 >)            | X | X | X | X | - | - | - | - |
|  | Outback (2012 >)                | X | • | X | • | - | - | - | - |
|  | XV Hatchback (2011 >)           | X | • | X | • | - | - | - | - |

Suzuki

|  |                           |   |   |   |   |   |   |   |   |
|--|---------------------------|---|---|---|---|---|---|---|---|
|  | Across (2020 >)           | X | • | X | • | - | - | - | - |
|  | Alto (2009 >)             | X | • | - | • | - | - | - | - |
|  | Baleno 2016 (2016 >)      | X | • | X | • | - | - | - | - |
|  | Celerio 2016 5dr (2015 >) | X | X | X | X | - | - | - | - |
|  | Grand Vitara (2005 >)     | X | • | X | • | - | - | - | - |
|  | Ignis 2016 (2016 >)       | X | • | - | • | - | - | - | - |
|  | SX-4 5dr (2006 >)         | X | • | X | • | - | - | - | - |
|  | Splash (2008 >)           | X | • | X | • | - | - | - | - |
|  | Swift 2017 (2017 >)       | X | • | X | • | - | - | - | - |
|  | Swift Sport 5dr (2011 >)  | X | • | X | • | - | - | - | - |
|  | Vitara 2015 (2015 >)      | X | • | X | • | - | - | - | - |

Tesla

|  |                  |   |   |   |   |   |   |   |   |
|--|------------------|---|---|---|---|---|---|---|---|
|  | Model 3 (2017 >) | X | • | X | • | - | - | - | - |
|  | Model 3 (2019 >) | X | • | X | • | - | - | - | - |
|  | Model S (2012 >) | X | • | X | • | - | - | - | - |
|  | Model X (2015 >) | X | • | - | • | X | - | X | - |
|  | Model Y (2022 >) | X | • | X | • | - | - | - | - |

Toyota

|  |                                |   |   |   |   |   |   |   |   |
|--|--------------------------------|---|---|---|---|---|---|---|---|
|  | <b>SB!</b> 2013 Verso (2013 >) | X | X | X | X | - | - | - | - |
|  | Auris (2007 - 2013)            | X | • | X | • | - | - | - | - |
|  | Auris (2013 >)                 | X | • | X | • | - | - | - | - |
|  | Avenis Hatch (2003 - 2011)     | X | • | X | • | - | - | - | - |
|  | Aygo 2014 (2014 >)             | X | • | - | • | - | - | - | - |
|  | Aygo 2019 (2019 >)             | X | • | - | • | - | - | - | - |
|  | Aygo 3dr (2005 >)              | X | • | - | • | - | - | - | - |
|  | Aygo X 2021 (2021 >)           | X | • | X | • | - | - | - | - |
|  | C-HR (2017 >)                  | X | • | X | • | - | - | - | - |
|  | Corolla 2018 (2018 >)          | X | • | X | • | - | - | - | - |
|  | EZ Mpv (2013 >)                | X | X | X | X | - | - | - | - |

|  |                                |   |   |   |   |   |   |   |   |
|--|--------------------------------|---|---|---|---|---|---|---|---|
|  | GT86 (2012 >)                  | X | X | - | X | - | - | - | - |
|  | Highlander (2013 >)            | X | X | X | . | . | - | - | - |
|  | Highlander 2021 (2021 >)       | X | X | X | . | . | - | - | - |
|  | Land Cruiser (2003 - 2009)     | X | X | X | . | . | - | - | - |
|  | Landcruiser (2009 >)           | X | X | X | . | . | - | - | - |
|  | Prius 2 (2004 - 2009)          | X | X | X | . | . | - | - | - |
|  | Prius 3 (2010 >)               | X | X | X | . | . | - | - | - |
|  | Prius 4 (2016) (2015 >)        | X | X | X | . | . | - | - | - |
|  | Prius PHEV 3 (2015>)           | X | X | X | . | . | - | - | - |
|  | Prius Plus+ (2012 >)           | X | X | X | X | . | - | - | - |
|  | RAV 4 (2006 - 2012)            | X | X | X | . | . | - | - | - |
|  | RAV4 (2013 >)                  | X | X | X | . | . | - | - | - |
|  | RAV4 2019 (2019 >)             | X | X | X | . | . | - | - | - |
|  | RAV4 Hybrid (2015 >)           | X | X | X | . | . | - | - | - |
|  | RAV4 Hybrid (2015 >)           | X | X | X | . | . | - | - | - |
|  | <b>SB!</b> Verso (2009 - 2012) | X | X | X | X | . | - | - | - |
|  | Yaris 2017 > (2017 >)          | X | X | X | . | . | - | - | - |
|  | Yaris 2019 (2019 >)            | X | X | X | . | . | - | - | - |
|  | Yaris Cross 2022 (2022 >)      | X | X | X | . | . | - | - | - |
|  | Yaris Hatch (2011 >)           | X | X | X | . | . | - | - | - |
|  | Yaris Hatch 5dr (2006 - 2011)  | X | X | X | . | . | - | - | - |

vw

|  |                                    |   |   |   |   |   |   |   |   |
|--|------------------------------------|---|---|---|---|---|---|---|---|
|  | Amarok Double-Cab (2022>)          | X | . | X | . | . | - | - | - |
|  | Arteon 2017 > (2017 >)             | X | X | X | . | . | - | - | - |
|  | Beetle (2012 >)                    | X | X | - | X | . | - | - | - |
|  | Beetle 1999 (1999 - 2005)          | X | X | - | X | . | - | - | - |
|  | <b>SB!</b> Caddy MaxiLife (2010 >) | X | . | X | . | X | - | X | - |
|  | E-Golf Hatch Mk7 (2015 >)          | X | X | X | . | . | - | - | - |
|  | E-UP! 5dr (2015 >)                 | X | X | X | . | . | - | - | - |
|  | Golf Cabriolet (2009 >)            | X | X | - | X | . | - | - | - |
|  | Golf GTE Hatch Mk7 (2015 >)        | X | X | X | . | . | - | - | - |
|  | Golf Hatch (2009 - 2013)           | X | X | X | X | . | - | - | - |
|  | Golf Hatch Mk5 (2004 - 2008)       | X | X | X | X | . | - | - | - |
|  | Golf Hatch Mk7 (2012 >)            | X | X | X | . | . | - | - | - |
|  | Golf Plus (2009 - 2013)            | X | X | X | X | . | - | - | - |
|  | ID3 EV (2020 >)                    | X | X | X | . | . | - | - | - |
|  | ID4 EV (2021 >)                    | X | X | X | . | . | - | - | - |
|  | ID5 EV (2022 >)                    | X | X | X | . | . | - | - | - |
|  | Jetta (2011 >)                     | X | X | X | . | . | - | - | - |

|  |                                 |   |   |   |   |   |   |   |   |
|--|---------------------------------|---|---|---|---|---|---|---|---|
|  | Lupo (1999 - 2005)              | X | . | . | . | . | - | - | - |
|  | Multivan Caravelle (2008 >)     | X | . | . | . | . | X | . | . |
|  | Passat CC (2008 >)              | X | . | X | . | . | - | - | - |
|  | Passat Estate (2005 - 2011)     | X | X | X | X | . | - | - | - |
|  | Passat Estate (2011-2015)       | X | X | X | X | . | - | - | - |
|  | Passat Estate 2015 (2015 >)     | X | . | X | . | . | - | - | - |
|  | Passat Saloon (2005 - 2011)     | X | . | X | . | . | - | - | - |
|  | Passat Saloon (2011-2015)       | X | . | X | . | . | - | - | - |
|  | Passat Saloon 2015 (2015 >)     | X | . | X | . | . | - | - | - |
|  | Polo 2017 (2017 >)              | X | . | X | . | . | - | - | - |
|  | Polo 3dr (2009 >)               | X | . | X | . | . | - | - | - |
|  | Polo 5dr (2009 >)               | X | . | X | . | . | - | - | - |
|  | Scirocco (2011 >)               | X | . | . | . | . | - | - | - |
|  | <b>SB!</b> Sharan (2010 >)      | X | X | - | X | X | - | X | - |
|  | T-Cross (2019 >)                | X | . | X | . | . | - | - | - |
|  | T-Roc (2017 >)                  | X | . | X | . | . | - | - | - |
|  | Taigo (2022 >)                  | X | . | X | . | . | - | - | - |
|  | Tiguan (2008 >)                 | X | X | X | X | . | - | - | - |
|  | Tiguan 2016 (2016 >)            | X | X | X | X | . | - | - | - |
|  | Tiguan Allspace 2017 > (2017 >) | X | . | X | . | X | - | X | - |
|  | Touareg (2012 >)                | X | . | X | . | . | - | - | - |
|  | Touareg (2003 - 2010)           | X | X | X | X | . | - | - | - |
|  | Touareg 2018 (2018 >)           | X | . | X | . | . | - | - | - |
|  | Touran 2016 (2016 >)            | X | X | X | X | . | - | X | - |
|  | <b>SB!</b> Touran (2010 >)      | X | X | X | X | X | - | X | - |
|  | UP! 5dr (2015 >)                | X | . | X | . | . | - | - | - |

Vauxhall







|  |                            |   |   |   |   |   |   |   |   |
|--|----------------------------|---|---|---|---|---|---|---|---|
|  | Adam (2013 >)              | X | X | - | X | . | - | - | - |
|  | Agila (2008 >)             | X | . | X | . | . | - | - | - |
|  | Ampera (2011 >)            | X | . | . | . | . | - | - | - |
|  | Antara (2007 >)            | X | . | X | . | . | - | - | - |
|  | Astra 2010 5dr (2010 >)    | X | X | X | X | . | - | - | - |
|  | Astra 2015 (2015 >)        | X | . | X | . | . | - | - | - |
|  | Astra GTC (2011 >)         | X | . | X | . | . | - | - | - |
|  | Astra Saloon (1998 - 2004) | X | X | X | X | . | - | - | - |
|  | Corisa 5dr 2015 (2015 >)   | X | . | X | . | . | - | - | - |
|  | Corisa Hatch 5dr (2006 >)  | X | . | X | . | . | - | - | - |
|  | Insignia Hatch (2009 >)    | X | . | X | . | . | - | - | - |
|  | Meriva (2010 >)            | X | X | X | X | . | - | - | - |



① ② ③ ④ ⑤ ⑥ ⑦

|   |                              |   |   |   |   |   |   |   |
|---|------------------------------|---|---|---|---|---|---|---|
|   | Mokka (2013 >)               | X | • | X | • | - | - | - |
|   | Vectra 2005 (2005 - 2008)    | X | • | X | • | - | - | - |
|   | Viva (2015 >)                | X | • | X | • | - | - | - |
|   | Zafira (2005 >)              | X | X | X | X | - | - | - |
|   | Zafira Tourer (2012 >)       | X | X | X | X | X | - | X |
|  | /Opel Crossland X (2018 >)   | X | • | X | • | - | - | - |
|  | /Opel Grandland X (2019 >)   | X | • | X | • | - | - | - |
|  | /Opel Insignia 2018 (2018 >) | X | • | X | • | - | - | - |

Volvo

|   |                            |   |   |   |   |   |   |   |
|---|----------------------------|---|---|---|---|---|---|---|
|   | C30 (2007 - 2013)          | X | X | - | X | - | - | - |
|   | S40 (2004 - 2012)          | X | • | X | • | - | - | - |
|  | S90 2016 (2016 >)          | X | • | X | • | - | - | - |
|   | V40 (2013 >)               | X | • | X | • | - | - | - |
|   | V40 Cross Country (2013 >) | X | • | X | • | - | - | - |
|   | V50 (2004 - 2012)          | X | • | X | • | - | - | - |
|   | V60 (2011 >)               | X | X | X | X | - | - | - |
|   | V60 Plug-In (2015 >)       | X | X | X | X | - | - | - |
|  | V60 (2018 >)               | X | • | X | • | - | - | - |
|  | V90 2016 (2016 >)          | X | • | X | • | - | - | - |
|  | XC40 (2018 >)              | X | • | X | • | - | - | - |
|   | XC60 (2013 >)              | X | X | X | X | - | - | - |
|  | XC60 2017 (2017 >)         | X | • | X | • | - | - | - |
|   | XC70 (2008 >)              | X | • | X | • | - | - | - |
|  | XC90 (2003 - 2015)         | X | X | X | X | - | - | - |
|  | XC90 2016 (2016 >)         | X | • | X | • | X | - | X |

76-105cms FF no SIP

① ② ③ ④ ⑤ ⑥ ⑦







Alfa Romeo

|   |                    |   |   |   |   |   |   |   |
|---|--------------------|---|---|---|---|---|---|---|
|   | 4C Coupe (2014 >)  | X | - | - | - | - | - | - |
|  | Giulia (2017 >)    | X | • | X | • | - | - | - |
|   | Giulietta (2010 >) | X | • | X | • | - | - | - |
|   | MiTo 3dr (2009 >)  | X | • | - | • | - | - | - |
|  | Stelvio (2017 >)   | X | • | X | • | - | - | - |

Aston Martin

|  |                  |   |   |   |   |   |   |   |
|--|------------------|---|---|---|---|---|---|---|
|  | DB11 (2019 >)    | X | X | - | X | - | - | - |
|  | DBS (2019 >)     | X | X | - | X | - | - | - |
|  | Vantage (2019 >) | X | - | - | - | - | - | - |

Audi

|  |                               |   |   |   |   |   |   |   |
|--|-------------------------------|---|---|---|---|---|---|---|
|   | A1 2018 5dr (2018 >)          | X | • | X | • | - | - | - |
|  | A1 Sportback 5dr (2012 >)     | X | • | X | • | - | - | - |
|  | A3 2004 5dr (2005 - 2011)     | X | • | X | • | - | - | - |
|  | A3 3dr (1996 - 2003)          | X | • | X | • | - | - | - |
|  | A3 Hatch 5dr (2012 >)         | X | • | X | • | - | - | - |
|  | A3 S3 5dr (2012 >)            | X | • | X | • | - | - | - |
|  | A3 Saloon (2014 >)            | X | • | X | • | - | - | - |
|  | A3 e-Tron Sportback (2015 >)  | X | • | X | • | - | - | - |
|  | A4 2005 (2005 - 2008)         | X | • | X | • | - | - | - |
|   | A4 2015 (2015 >)              | X | • | X | • | - | - | - |
|  | A4 Avant (2008 >)             | X | • | X | • | - | - | - |
|  | A5 Sportback (2009 >)         | X | • | X | • | - | - | - |
|   | A5/S5 Cabriolet 2017 (2017 >) | X | • | - | • | - | - | - |
|  | A5/S5 Coupe 2016 (2016 >)     | X | • | - | • | - | - | - |
|    | A5/S5 Sportback 2017 (2017 >) | X | • | X | • | - | - | - |
|  | A6 Allroad (2011 >)           | X | • | X | • | - | - | - |
|  | A6 Avant (2011 >)             | X | • | X | • | - | - | - |
|  | A7 Sportback (2011 >)         | X | • | X | • | - | - | - |
|  | A7/S7 Sportback (2016 >)      | X | • | X | • | - | - | - |
|  | A7/S7 Sportback 2018 (2018 >) | X | • | X | • | - | - | - |
|  | A8 (2011 >)                   | X | • | X | • | - | - | - |
|  | A8 S8 (2011 >)                | X | • | X | • | - | - | - |
|   | A8/S8 2018 (2018 >)           | X | • | X | • | - | - | - |
|  | Q2 (2016 >)                   | X | • | X | • | - | - | - |
|  | Q3 (2011 >)                   | X | • | X | • | - | - | - |

① ② ③ ④ ⑤ ⑥ ⑦

|  |                      |   |   |   |   |   |   |   |   |
|--|----------------------|---|---|---|---|---|---|---|---|
|  | Q3 (2019 >)          | X | • | X | • | - | - | - | - |
|  | Q4 e-Tron (2021 >)   | X | • | X | • | - | - | - | - |
|  | Q5 (2009 >)          | X | • | X | • | - | - | - | - |
|  | Q5/SQ5 2017 (2017 >) | X | • | X | • | - | - | - | - |
|  | Q7 (2006 >)          | X | • | X | • | - | - | - | - |
|  | Q7 2015 (2015 >)     | X | • | X | • | X | - | X | - |
|  | Q8 (2018 >)          | X | • | X | • | - | - | - | - |
|  | TT Coupe (2008 >)    | X | X | - | X | - | - | - | - |

**BMW**

|  |                                    |   |   |   |   |   |   |   |   |
|--|------------------------------------|---|---|---|---|---|---|---|---|
|  | 1 Series (f20) 5dr (2011 >)        | X | • | X | • | - | - | - | - |
|  | 1-Series 5dr (2004 - 2010)         | X | • | X | • | - | - | - | - |
|  | 1-Series Cabrio (2008 >)           | X | • | - | - | - | - | - | - |
|  | 1-Series Coupe (2008 >)            | X | • | - | - | - | - | - | - |
|  | 2-Series AC-T (2015 >)             | X | • | X | • | - | - | - | - |
|  | 2-Series Coupe (2014 >)            | X | • | - | - | - | - | - | - |
|  | 3 Series (f30) (2012 >)            | X | • | X | • | - | - | - | - |
|  | 3-Series (E46) Coupe (2002 - 2006) | X | • | X | • | - | - | - | - |
|  | 3-Series Coupe (E90) (2007 >)      | X | • | - | - | - | - | - | - |
|  | 3GT (2013 >)                       | X | • | X | • | - | - | - | - |
|  | 4-Series Gran Coupe (2014 >)       | X | • | X | • | - | - | - | - |
|  | 5-GT (2010 >)                      | X | • | X | • | - | - | - | - |
|  | 5-Series (F10) (2011 >)            | X | • | X | • | - | - | - | - |
|  | 5-Series (E60) (2003 - 2010)       | X | • | X | • | - | - | - | - |
|  | 5-Series 2018 (2018 >)             | X | • | X | • | - | - | - | - |
|  | 6-Series Cabrio (2011 >)           | X | • | - | - | - | - | - | - |
|  | 6-Series Coupe (2Dr) (2011 >)      | X | • | - | - | - | - | - | - |
|  | 6-Series Gran Coupe (4Dr) (2011 >) | X | • | X | • | - | - | - | - |
|  | 7-Series (2010 >)                  | X | • | X | • | - | - | - | - |
|  | 7-Series 2015 (2015 >)             | X | • | X | • | - | - | - | - |
|  | X1 (2009 - 2015)                   | X | • | X | • | - | - | - | - |
|  | X1 2016 (2016 >)                   | X | • | X | • | - | - | - | - |
|  | X3 (F25) (2011 >)                  | X | • | X | • | - | - | - | - |
|  | X3 2018 (2018 >)                   | X | • | X | • | - | - | - | - |
|  | X4 (2014 >)                        | X | • | X | • | - | - | - | - |
|  | X5 2000 (2000 - 2006)              | X | X | X | X | - | - | - | - |
|  | X5 2007 (2007 - 2014)              | X | • | X | • | X | - | X | - |
|  | X5 2015 (2015 >)                   | X | • | X | • | X | - | X | - |
|  | X6 (2009 >)                        | X | • | X | • | - | - | - | - |
|  | X6 2015 (2015 >)                   | X | • | - | - | - | - | - | - |

① ② ③ ④ ⑤ ⑥ ⑦

|  |              |   |   |   |   |   |   |   |   |
|--|--------------|---|---|---|---|---|---|---|---|
|  | i3 (2014 >)  | X | • | - | • | - | - | - | - |
|  | i8 (2014 >)  | X | X | - | X | - | - | - | - |
|  | iX (2021 >)  | X | • | X | • | - | - | - | - |
|  | iX3 (2022 >) | X | • | X | • | - | - | - | - |

**Bentley**

|  |                                   |   |   |   |   |   |   |   |   |
|--|-----------------------------------|---|---|---|---|---|---|---|---|
|  | Continental Flying Spur (2005 >)  | X | • | X | • | - | - | - | - |
|  | Continental GT (2003 - 2012)      | X | • | - | - | - | - | - | - |
|  | Continental GT Conv (2006 - 2012) | X | • | - | - | - | - | - | - |
|  | Mulsanne (2012 >)                 | X | • | X | • | - | - | - | - |

**Cadillac**

|  |                   |   |   |   |   |   |   |   |   |
|--|-------------------|---|---|---|---|---|---|---|---|
|  | BLS (2005 - 2012) | X | • | X | • | - | - | - | - |
|--|-------------------|---|---|---|---|---|---|---|---|

**Chevrolet**





|  |                    |   |   |   |   |   |   |   |   |
|--|--------------------|---|---|---|---|---|---|---|---|
|  | Aveo 5dr (2012 >)  | X | • | X | • | - | - | - | - |
|  | Captiva (2010 >)   | X | • | X | • | - | - | - | - |
|  | Cruze (2011 >)     | X | • | X | • | - | - | - | - |
|  | Orland (2011 >)    | X | • | X | • | - | - | - | - |
|  | Spark 5dr (2012 >) | X | • | X | • | - | - | - | - |
|  | Traxx (2013 >)     | X | • | X | • | - | - | - | - |
|  | Volt (2011 >)      | X | • | - | - | - | - | - | - |

**Chrysler**

|  |                        |   |   |   |   |   |   |   |   |
|--|------------------------|---|---|---|---|---|---|---|---|
|  | 300C (2012 >)          | X | • | X | • | - | - | - | - |
|  | Delta (2007 >)         | X | • | X | • | - | - | - | - |
|  | Grand Voyager (2008 >) | X | • | - | - | X | X | X | X |
|  | Ypsilon 3dr (2012 >)   | X | • | X | • | - | - | - | - |

**Citroen**

|  |   |   |   |   |   |   |   |   |   |
|--|---|---|---|---|---|---|---|---|---|
|  | <b>SB!</b> Berlingo II (2008 >)         | X | • | X | • | - | - | - | - |
|  | <b>SB!</b> Berlingo Multispace (2007 >) | X | X | X | X | X | - | X | - |
|  | C-Cactus (2015)                         | X | • | X | • | - | - | - | - |
|  | C1 2015 5dr (2015 >)                    | X | • | - | - | - | - | - | - |
|  | C1 3dr (2006 >)                         | X | • | - | - | - | - | - | - |
|  | C3 5Dr (2009 >)                         | X | • | X | • | - | - | - | - |

|   |  |   |   |   |   |   |   |   |
|---|--|---|---|---|---|---|---|---|
|   | C3 5dr 2005 (2005 - 2009)  | X | • | X | • | - | - | - |
|  |  C3 5dr 2016 (2016 >) | X | • | X | • | - | - | - |
|   | C3 Aircross (2017 >)   | X | • | X | • | - | - | - |
|   | <b>SB!</b> C3 Picasso (2009 >)   | X | • | X | • | - | - | - |
| <b>SB!</b>  | C4 G-Picasso 2007 (2007 - 2013)  | X | • | • | • | X | - | X |
|   | <b>SB!</b> C4 G-Picasso (2014 >)   | X | • | • | • | X | - | X |
| <b>SB!</b>  | C4 Picasso (2007 - 2013)   | X | • | X | • | - | - | - |
|   | C5 (2008 >)  | X | • | X | • | - | - | - |
|   | C5 2005 (2005 - 2008)  | X | • | X | • | - | - | - |
|  | C5 Aircross (2019 >)   | X | • | X | • | - | - | - |
|   | C5 Tourer (2009 >)   | X | • | X | • | - | - | - |
|   | DS3 (2011 >)   | X | • | X | • | - | - | - |
|   | DS3 Cabrio (2013 >)  | X | • | X | • | - | - | - |
|  | DS3 Crossback (2019 >)   | X | • | X | • | - | - | - |
|   | DS4 (2011 >)   | X | • | X | • | - | - | - |
|   | DS5 (2013 >)   | X | • | X | • | - | - | - |
|  | DS7 (2018 >)   | X | • | X | • | - | - | - |
|   | Jumpy (2007 - 2016)  | X | • | X | • | X | - | X |
|   | Nemo (2008 >)  | X | • | X | • | - | - | - |
|   | Xsara 5dr (2000 - 2004)  | X | • | X | • | X | - | - |
| <b>SB!</b>  | Xsara Picasso (2000 - 2012)  | X | • | X | • | - | - | - |



















Dacia

|                                 |   |   |   |   |   |   |   |   |
|---------------------------------|---|---|---|---|---|---|---|---|
|                                 |  Duster (2012 >) | X | • | X | • | - | - | - |
|                                 |  Jogger (2022 >) | X | • | X | • | - | - | - |
|                                 | Logan MCV (2013 >)  | X | • | X | • | - | - | - |
| Logan MCV 2006 (2008/11-2013/7) |   | X | • | X | • | - | - | - |
|                                 | Sandero (2013 >)  | X | • | X | • | - | - | - |

FIAT

|   |                                   |   |   |   |   |   |   |   |
|---|-----------------------------------|---|---|---|---|---|---|---|
|   | 124 Spider 2016 (2016 >)          | X | - | - | - | - | - | - |
|   | 500 (2008 >)                      | X | • | - | • | - | - | - |
|  | 500L (2013 >)                     | X | • | X | • | - | - | - |
|   | 500X (2015 >)                     | X | • | X | • | - | - | - |
|   | Bravo (2007 >)                    | X | • | X | • | - | - | - |
|   | Doblo (2007 >)                    | X | • | X | • | - | - | - |
|   | Panda (2012 >)                    | X | • | X | • | - | - | - |
|   | Punto 3dr (Grande Punto) (2006 >) | X | • | X | • | - | - | - |
|   | Qubo (2008 >)                     | X | • | X | • | - | - | - |

Ford

|  |  |   |   |   |   |   |   |   |
|--|--|---|---|---|---|---|---|---|
|  |  Tipo 2016 (2016 >)        | X | • | X | • | - | - | - |
|   | Galaxy 2016 (2016 >)   | X | • | X | • | X | - | X |
|  | B-Max (2012 >)   | X | • | X | • | - | - | - |
|  | C-Max 2013 (2011 >)  | X | • | X | • | - | - | - |
| <b>SB!</b>   | C-Max (2003 - 2013)  | X | • | X | • | X | - | - |
|   | EcoSport (2015 >)  | X | • | X | • | - | - | - |
| <b>SB!</b>   | Edge (2016 >)  | X | • | X | • | X | - | X |
| Fiesta 2004 3dr (2004 - 2008)  |  | X | • | X | • | X | - | X |
|  | Fiesta 2008 5dr (2008 >)   | X | • | X | • | - | - | - |
|   | Fiesta 2017 > (2017 >)   | X | • | X | • | - | - | - |
|  | Focus (2010 >)   | X | • | X | • | - | - | - |
|   | Focus 2005 (2005 - 2009)   | X | • | X | • | X | - | - |
|  | Focus 2018 (2018 >)  | X | • | X | • | - | - | - |
|  | Focus EV (2015 >)  | X | • | X | • | - | - | - |
|  | Focus Mk1 (1998 - 2004)  | X | • | X | • | X | - | - |
|  | Galaxy (2006 >)  | X | • | X | • | X | - | X |
|   | Ka 3dr (2009 - 2013)   | X | • | - | • | - | - | - |
|  | Ka+ 2016 5dr (2016 >)  | X | • | X | • | - | - | - |
|  | Kuga 2008 (2008 - 2012)  | X | • | X | • | - | - | - |
|   |  Kuga 2013 (2013 >)       | X | • | X | • | - | - | - |
|  |  Kuga 2017 (2017 >)       | X | • | X | • | - | - | - |
|  |  Kuga 2020 (2020 >)       | X | • | X | • | - | - | - |
|  | Mondeo 2000 (2000 - 2007)  | X | • | X | • | X | - | - |
|  | Mondeo Estate (2007 >)   | X | • | X | • | - | - | - |
|  | Mustang Cabrio 2015 (2015 >)   | X | • | - | - | - | - | - |
|  | Mustang Coupe 2015 (2015 >)  | X | • | - | - | - | - | - |
|    |  Mustang Mach E (2022 >)  | X | • | X | • | - | - | - |
|   |  New Mondeo 2014 (2014 >) | X | • | X | • | - | - | - |
|  | Puma (2020 >)  | X | • | X | • | - | - | - |
|  | Ranger Double-Cab Pickup (2019 >)  | X | • | X | • | - | - | - |
|  | S-Max (2006 >)   | X | • | X | • | X | - | X |
|   | S-Max 2015 (2015 >)  | X | • | X | • | X | - | X |
|  |  G80 (2021 >)             | X | • | X | • | - | - | - |
|  |  GV80 SUV (2021 >)       | X | • | X | • | - | - | - |

Genesis

Honda

|  |                             |   |   |   |   |   |   |   |
|--|-----------------------------|---|---|---|---|---|---|---|
|  | Accord Saloon (2008 >)      | X | • | X | • | - | - | - |
|  | CR-V (2007 - 2012)          | X | • | X | • | - | - | - |
|  | CR-V 2012 (2012 >)          | X | • | X | • | - | - | - |
|  | CR-V 2019 (2019 >)          | X | • | X | • | X | - | X |
|  | Civic (2012 >)              | X | • | X | • | - | - | - |
|  | Civic (2006 - 2011)         | X | • | X | • | - | - | - |
|  | Civic 2017 (2017 >)         | X | • | X | • | - | - | - |
|  | Civic Saloon 2019 (2019 >)  | X | • | X | • | - | - | - |
|  | Civic Tourer (2014 >)       | X | • | X | • | - | - | - |
|  | E (2021>)                   | X | • | X | • | - | - | - |
|  | Elysion (2012 >)            | X | • | - | • | X | X | X |
|  | FRV (2006 - 2011)           | X | • | X | • | - | - | - |
|  | HR-V (2015 >)               | X | • | X | • | - | - | - |
|  | HR-V 2022 (2022 >)          | X | • | X | • | - | - | - |
|  | Insight (2009 >)            | X | X | X | X | - | - | - |
|  | Jazz (2008 - 2015)          | X | • | X | • | - | - | - |
|  | Jazz 2002 (2002 - 2008)     | X | X | X | X | - | - | - |
|  | Jazz 2016 (2016 >)          | X | • | X | • | - | - | - |
|  | Jazz 2020 (2020 >)          | X | • | X | • | - | - | - |
|  | Jazz Crosstar 2021 (2021 >) | X | • | X | • | - | - | - |
|  | Odyssey (2010 >)            | X | X | - | X | - | - | - |

Hyundai

|  |                             |   |   |   |   |   |   |   |
|--|-----------------------------|---|---|---|---|---|---|---|
|  | Genesis Sedan (2016 >)      | X | • | X | • | - | - | - |
|  | Getz 5dr (2005 - 2011)      | X | • | X | • | - | - | - |
|  | Ioniq Hybrid (2016 >)       | X | • | X | • | - | - | - |
|  | Ix20 (2011 >)               | X | • | X | • | - | - | - |
|  | Kona 2017 > (2017 >)        | X | • | X | • | - | - | - |
|  | Santa Fe (2012 >)           | X | • | X | • | X | - | X |
|  | Santa Fe 2007 (2007 - 2012) | X | • | X | • | X | - | X |
|  | Tucson 2015 (2015 >)        | X | • | X | • | - | - | - |
|  | Veloster (2012 >)           | X | • | - | - | - | - | - |
|  | i10 2014 5dr (2014 >)       | X | • | X | • | - | - | - |
|  | i10 5dr (2008 >)            | X | • | X | • | - | - | - |
|  | i20 2014 > (2014 >)         | X | • | X | • | - | - | - |
|  | i20 2015 (2015 >)           | X | • | X | • | - | - | - |
|  | i20 Hatch (2009 >)          | X | • | X | • | - | - | - |
|  | i30 Hatch (2012 >)          | X | • | X | • | - | - | - |

|  |                              |   |   |   |   |   |   |   |
|--|------------------------------|---|---|---|---|---|---|---|
|  | i30 Hatch 2015 (2015 - 2017) | X | • | X | • | - | - | - |
|  | i30 Hatch 2017 (2017 >)      | X | • | X | • | - | - | - |
|  | i40 (2011 >)                 | X | • | X | • | - | - | - |
|  | i800/H1 (2008 >)             | X | • | X | • | X | X | X |
|  | ix35 (2010 >)                | X | • | X | • | - | - | - |

Infiniti

|  |                   |   |   |   |   |   |   |   |
|--|-------------------|---|---|---|---|---|---|---|
|  | EX SUV (2009 >)   | X | • | X | • | - | - | - |
|  | FX SUV (2009 >)   | X | • | X | • | - | - | - |
|  | G Coupe (2009 >)  | X | • | - | - | - | - | - |
|  | G Saloon (2009 >) | X | • | X | • | - | - | - |
|  | M Saloon (2010 >) | X | • | X | • | - | - | - |

Jaguar

|  |  |                         |   |   |   |   |   |   |
|--|--|-------------------------|---|---|---|---|---|---|
|  |  | E-Pace (2018 >)         | X | • | X | • | - | - |
|  |  | F-Pace (2016 >)         | X | • | X | • | - | - |
|  |  | F-Type Coupe (2014 >)   | X | - | - | - | - | - |
|  |  | I-Pace (2018 >)         | X | • | X | • | - | - |
|  |  | X-Type (2001 - 2010)    | X | X | X | X | - | - |
|  |  | XE (2015 >)             | X | • | X | • | - | - |
|  |  | XF (2008 >)             | X | • | X | • | - | - |
|  |  | XF 2015 (2015 >)        | X | • | X | • | - | - |
|  |  | XF Estate 2015 (2015 >) | X | • | X | • | - | - |
|  |  | XF Sportbrake (2012 >)  | X | • | X | • | - | - |
|  |  | XJ (2010 >)             | X | • | X | • | - | - |
|  |  | XK Coupe (2006 >)       | X | • | - | • | - | - |

Jeep

|  |  |                         |   |   |   |   |   |   |
|--|--|-------------------------|---|---|---|---|---|---|
|  |  | Cherokee 2014 (2014 >)  | X | • | X | • | - | - |
|  |  | Compass (2011 >)        | X | • | X | • | - | - |
|  |  | Grand Cherokee (2011 >) | X | • | X | • | - | - |
|  |  | Renegade 2015 (2015 >)  | X | • | X | • | - | - |
|  |  | Wrangler 5Dr (2007 >)   | X | X | X | X | - | - |

Kia

|  |  |                    |   |   |   |   |   |   |
|--|--|--------------------|---|---|---|---|---|---|
|  |  | Ceed 2020 (2020 >) | X | • | X | • | - | - |
|  |  | EV6 (2022 >)       | X | • | X | • | - | - |

① ② ③ ④ ⑤ ⑥ ⑦

|            |                                |   |   |   |   |   |   |   |
|------------|--------------------------------|---|---|---|---|---|---|---|
|            | Sorento 2015 (2015 >)          | X | • | X | • | X | - | X |
|            | Sorento 2020 (2020 >)          | X | • | X | • | X | - | X |
|            | Soul EV (2015 >)               | X | • | X | • | - | - | - |
|            | Soul EV 2019 (2019 >)          | X | • | X | • | - | - | - |
|            | Xceed (2020 >)                 | X | • | X | • | - | - | - |
| <b>SB!</b> | Carens 2013 (2013 >)           | X | • | X | • | X | - | X |
|            | Cee'D Hatch (2012 >)           | X | • | X | • | - | - | - |
|            | Cee'D Hatch (2012 >)           | X | • | X | • | - | - | - |
|            | Niro 2017 (2017 >)             | X | • | X | • | - | - | - |
|            | Niro Hybrid 2022 (2022 >)      | X | • | X | • | - | - | - |
|            | Optima (2011 >)                | X | • | X | • | - | - | - |
|            | Optima 2016 (2016 >)           | X | • | X | • | - | - | - |
|            | Picanto 2012 5dr (2011 - 2015) | X | • | X | • | - | - | - |
|            | Picanto 2017 > (2017 >)        | X | • | X | • | - | - | - |
|            | Picanto 5dr (2008 >)           | X | • | X | • | - | - | - |
|            | Rio (2012 >)                   | X | • | X | • | - | - | - |
|            | Rio 2017 > (2017 >)            | X | • | X | • | - | - | - |
|            | Sorento (2012 >)               | X | • | X | • | - | - | - |
|            | Sorento (2003 - 2009)          | X | • | X | • | - | - | - |
|            | Soul (2009 >)                  | X | • | X | • | - | - | - |
|            | Sportage (2011 >)              | X | • | X | • | - | - | - |
|            | Sportage 2016 (2016 >)         | X | • | X | • | - | - | - |
|            | Sportage 2022 (2022 >)         | X | • | X | • | - | - | - |
|            | Stonic 2017 > (2017 >)         | X | • | X | • | - | - | - |
|            | Venga (2011 >)                 | X | • | X | • | - | - | - |

Lancia

|  |                      |   |   |   |   |   |   |   |
|--|----------------------|---|---|---|---|---|---|---|
|  | Thema (2012 >)       | X | • | X | • | - | - | - |
|  | Voyager (2010 >)     | X | • | - | • | X | X | X |
|  | Ypsilon 3dr (2012 >) | X | • | X | • | - | - | - |

Land Rover

|  |                           |   |   |   |   |   |   |   |
|--|---------------------------|---|---|---|---|---|---|---|
|  | Defender 2020 (2020 >)    | X | • | X | • | X | - | X |
|  | Discovery 4 (2009 >)      | X | • | X | • | - | - | - |
|  | Discovery 5 2017 (2017 >) | X | • | X | • | X | - | X |
|  | Discovery Sport (2015 >)  | X | • | X | • | X | - | X |
|  | Freelander 2 (2006 >)     | X | • | X | • | - | - | - |
|  | Range Rover (2002 - 2012) | X | • | X | • | - | - | - |
|  | Range Rover 2013 (2013 >) | X | • | X | • | - | - | - |

① ② ③ ④ ⑤ ⑥ ⑦

|  |  |   |   |   |   |   |   |   |
|--|--|---|---|---|---|---|---|---|
|  | Range Rover Evoque (2011 >)            | X | • | X | • | - | - | - |
|  | Range Rover Evoque (5dr) 2019 (2019 >) | X | • | X | • | - | - | - |
|  | Range Rover Evoque 5 door (2011 >)     | X | • | X | • | - | - | - |
|  | Range Rover Sport (2005 - 2012)        | X | • | X | • | - | - | - |
|  | Range Rover Sport (2013 >)             | X | • | X | • | - | - | - |
|  | Range Rover VELAR (2017 >)             | X | • | X | • | - | - | - |

Lexus

|  |                        |   |   |   |   |   |   |   |
|--|------------------------|---|---|---|---|---|---|---|
|  | CT (2011 >)            | X | • | X | • | - | - | - |
|  | ES Hybrid (2019 >)     | X | • | X | • | - | - | - |
|  | GS (2013 >)            | X | • | X | • | - | - | - |
|  | IS (2005 >)            | X | • | X | • | - | - | - |
|  | IS 200 (2004) (1999 >) | X | • | X | • | - | - | - |
|  | NX (2014 >)            | X | • | X | • | - | - | - |
|  | RX (2010 >)            | X | • | X | • | - | - | - |
|  | RX 2016 (2017 >)       | X | • | X | • | - | - | - |
|  | UX (2019 >)            | X | • | X | • | - | - | - |

MG

|  |                      |   |   |   |   |   |   |   |
|--|----------------------|---|---|---|---|---|---|---|
|  | 5 EV Estate (2020 >) | X | • | X | • | - | - | - |
|  | GS (2016 >)          | X | • | X | • | - | - | - |
|  | HS PHEV SUV (2021 >) | X | • | X | • | - | - | - |
|  | HS SUV (2021 >)      | X | • | X | • | - | - | - |
|  | Motor MG6 (2012 >)   | X | • | X | • | - | - | - |
|  | ZS (2021 >)          | X | • | X | • | - | - | - |
|  | ZS EV (2021 >)       | X | • | X | • | - | - | - |



MINI

|  |                             |   |   |   |   |   |   |   |
|--|-----------------------------|---|---|---|---|---|---|---|
|  | Countryman (2010 >)         | X | • | X | • | - | - | - |
|  | Coupe (2009 >)              | X | - | - | - | - | - | - |
|  | Hatch (2006 >)              | X | X | - | X | - | - | - |
|  | Hatchback 3Dr 2014 (2014 >) | X | • | - | - | - | - | - |
|  | Hatchback 3dr (2000 - 2006) | X | X | - | X | - | - | - |
|  | Hatchback 5dr 2015 (2015 >) | X | • | X | • | - | - | - |
|  | Paceman (2013 >)            | X | • | - | • | - | - | - |





**Maserati**











|                            |   |   |   |   |   |   |   |
|----------------------------|---|---|---|---|---|---|---|
| Ghibli 2014 (2014 >)       | X | • | X | • | - | - | - |
| Gran Turismo 2007 (2007 >) | X | X | - | X | - | - | - |
| Levante (2017 >)           | X | • | X | • | - | - | - |
| Quattroporte 2016 (2016 >) | X | • | X | • | - | - | - |

**Mazda**



|   |   |   |   |   |   |   |   |
|---|---|---|---|---|---|---|---|
| 2 (2007 >)  | X | • | X | • | - | - | - |
|  2 2015 5dr (2015 >) | X | • | X | • | - | - | - |
| 3 Hatch (2009 - 2013)   | X | • | X | • | - | - | - |
| 3 Hatchback 2014 (2014 >)   | X | • | X | • | - | - | - |
| 5 (2005 - 2010)   | X | • | X | • | - | - | - |
|  6 (2007 - 2012)     | X | • | X | • | - | - | - |
| 6 2018 (2018 >)   | X | • | X | • | - | - | - |
| 6 Estate (2013 >)   | X | • | X | • | - | - | - |
|  6 Saloon (2013 >)   | X | • | X | • | - | - | - |
| CX-3 (2015 >)   | X | • | X | • | - | - | - |
| CX-5 (2011 >)   | X | • | X | • | - | - | - |
| CX-7 (2007 >)   | X | • | X | • | - | - | - |
| MX-5 2015 (2016 >)  | X | - | - | - | - | - | - |

**Mercedes-Benz**



|   |   |   |   |   |   |   |   |
|---|---|---|---|---|---|---|---|
| A Class (2005 - 2012)   | X | • | X | • | - | - | - |
| A-Class (2013 >)  | X | • | X | • | - | - | - |
|  A-Class Hatchback 2019 (2019 >) | X | • | X | • | - | - | - |
|  A-Class Saloon 2019 (2020 >)    | X | • | X | • | - | - | - |
| B-Class (2012 >)  | X | • | X | • | - | - | - |
| B-Class EV (2015 >)   | X | • | X | • | - | - | - |
| C-Class 2015 Estate (2015 >)  | X | • | X | • | - | - | - |
| C-Class Coupe (2011 >)  | X | • | - | - | - | - | - |
| C-Class Estate (2008 >)   | X | • | X | • | - | - | - |
| CLA (2013 >)  | X | • | X | • | - | - | - |
|  CLA 2019 (2020 >)               | X | • | X | • | - | - | - |
|  CLA Shooting-Brake (2015 >)     | X | • | X | • | - | - | - |
| CLS Coupe (2011 >)  | X | • | X | • | - | - | - |
| CLS Shooting Brake (2012 >)   | X | • | X | • | - | - | - |
| E-Class 2006 (2006 - 2009)  | X | • | X | • | - | - | - |
| E-Class Cabriolet 2017 (2017 >)   | X | • | - | - | - | - | - |

|   |   |   |   |   |   |   |   |
|---|---|---|---|---|---|---|---|
| E-Class Coupe (2009 >)  | X | • | - | • | - | - | - |
|  E-Class Coupe 2017 (2017 >) | X | • | - | • | - | - | - |
|  E-Class Estate (2013 >)     | X | • | X | • | - | - | - |
| E-Class Estate 2016 (2016 >)  | X | • | X | • | - | - | - |
| E-Class Saloon 2013 (2013 >)  | X | • | X | • | - | - | - |
|  EQA 2021 (2021 >)           | X | • | X | • | - | - | - |
|  EQC (2021 >)                | X | • | X | • | - | - | - |
|  GL Class (2012 >)           | X | • | X | • | - | - | - |
|  GLA 2021 (2021 >)           | X | • | X | • | - | - | - |
|  GLC (2016 >)                | X | • | X | • | - | - | - |
|  GLC Coupe (2019 >)          | X | • | X | • | - | - | - |
|  GLE (2015 >)                | X | • | X | • | - | - | - |
|  GLE 2020 (2020 >)           | X | • | X | • | X | - | X |
| R-Class (2006 - 2012)   | X | • | X | • | - | - | - |
| S Class 2015 (2014 >)   | X | • | X | • | - | - | - |
| S-Class (2006 - 2013)   | X | • | X | • | - | - | - |
| SL-Class (2012 >)   | X | - | - | - | - | - | - |
| SLK (2012 >)  | X | - | - | - | - | - | - |
| V-Class (2015 >)  | X | • | X | • | - | - | X |

**Mini**

|   |   |   |   |   |   |   |   |
|---|---|---|---|---|---|---|---|
|   Clubman 2016 (2016 >) | X | • | X | • | - | - | - |
|  Countryman 2017 (2017 >)  | X | • | X | • | - | - | - |

**Mitsubishi**

|  |   |   |   |   |   |   |   |
|--|---|---|---|---|---|---|---|
| ASX (2010 >)   | X | • | X | • | - | - | - |
|  Colt (2007 - 2013)     | X | • | X | • | - | - | - |
|  Eclipse Cross (2019 >) | X | • | X | • | - | - | - |
| Lancer (2008 - 2011 >)   | X | • | - | - | - | - | - |
| Lancer Sportback (2008 - 2011 >)   | X | • | - | - | - | - | - |
| Mirage (2012 >)  | X | • | X | • | - | - | - |
| Outlander (2007 - 2013)  | X | • | X | • | - | - | - |
| Outlander (2013 >)   | X | • | X | • | - | - | - |
| Outlander PHEV (2015 >)  | X | • | X | • | - | - | - |
| Shogun (2007 >)  | X | • | X | • | - | - | - |

**Nissan**

|                       |   |   |   |   |   |   |   |
|-----------------------|---|---|---|---|---|---|---|
| 2008 X-Trail (2008 >) | X | • | X | • | - | - | - |
|-----------------------|---|---|---|---|---|---|---|

① ② ③ ④ ⑤ ⑥ ⑦

|                           |   |   |   |   |   |   |   |
|---------------------------|---|---|---|---|---|---|---|
| Juke (2010 >)             | X | • | X | • | - | - | - |
| Leaf EV (2010 - 2017)     | X | • | X | • | - | - | - |
| Micra 2017 > (2017 >)     | X | • | X | • | - | - | - |
| Micra 5dr (2011 >)        | X | • | X | • | - | - | - |
| Murano 2016 (2016 >)      | X | • | X | • | - | - | - |
| Navara 2015 > (2015 >)    | X | • | X | • | - | - | - |
| Note (2006 - 2013)        | X | • | X | • | - | - | - |
| Note 2014 (2014 >)        | X | • | X | • | - | - | - |
| Pulsar 2015 (2015 >)      | X | • | X | • | - | - | - |
| Qashqai 2007 (2006 -2013) | X | • | X | • | - | - | - |
| Qashqai 2014 (2014 >)     | X | • | X | • | - | - | - |
| Qashqai+2 (2008 >)        | X | • | X | • | - | - | - |
| Quest MPV (2012 >)        | X | • | - | • | X | X | X |
| X-Trail 2015 (2015 >)     | X | • | X | • | X | - | X |





Opel

|   |   |   |   |   |   |   |   |
|---|---|---|---|---|---|---|---|
| Adam (2013 >)   | X | • | - | • | - | - | - |
| Agila (2008 >)  | X | • | X | • | - | - | - |
| Ampera (2011 >)   | X | • | - | • | - | - | - |
| Antara (2007 >)   | X | • | X | • | - | - | - |
| Astra 2003 5dr (2003 - 2009)  | X | • | X | • | - | - | - |
|  Astra 2010 5dr (2010 >) | X | • | X | • | - | - | - |
| Astra 2015 (2015 >)   | X | • | X | • | - | - | - |
| Astra GTC (2011 >)  | X | • | X | • | - | - | - |
| Corsa 5dr 2015 (2015 >)   | X | • | X | • | - | - | - |
| Corsa Hatch 5dr (2006 >)  | X | • | X | • | - | - | - |
| Insignia Hatch (2009 >)   | X | • | X | • | - | - | - |
| Karl (2015 >)   | X | • | X | • | - | - | - |
| Meriva (2010 >)   | X | • | X | • | - | - | - |
| Mokka (2013 >)  | X | • | X | • | - | - | - |
| Vectra 2005 (2002 - 2008)   | X | • | X | • | - | - | - |
| Zafira (2005 >)   | X | • | X | • | - | - | - |
| Zafira Tourer (2012 >)  | X | • | X | • | X | - | X |

Peugeot

|   |   |   |   |   |   |   |   |
|---|---|---|---|---|---|---|---|
| 107 3dr (2005 - 2013)   | X | • | - | • | - | - | - |
| 108 5dr (2015 >)  | X | • | - | • | - | - | - |
|  2008 (2013 >) | X | • | X | • | - | - | - |
| 2008 2020 (2020 >)  | X | • | X | • | - | - | - |

① ② ③ ④ ⑤ ⑥ ⑦

|  |   |   |   |   |   |   |   |
|--|---|---|---|---|---|---|---|
| 206 3dr (1998 - 2009)  | X | • | X | • | - | - | - |
| 207 3dr Hatchback (2006 - 2012)  | X | • | X | • | - | - | - |
| 207 5dr (2012 >)   | X | • | X | • | - | - | - |
|  208 2020 5dr (2020 >)        | X | • | X | • | - | - | - |
| 208 5dr (2012 >)   | X | • | X | • | - | - | - |
|  208 EV 2020 5dr (2020 >)     | X | • | X | • | - | - | - |
| 3008 2017 (2017 >)   | X | • | X | • | - | - | - |
| <b>SB!</b> 3008 (2009 >)   | X | • | X | • | - | - | - |
| 307 Hatchback (2001 - 2007)  | X | • | X | • | - | - | - |
| 308 (2014) (2014 >)  | X | • | X | • | - | - | - |
| 308 Hatchback (2007 >)   | X | • | X | • | - | - | - |
| 407 (2004 - 2011)  | X | • | X | • | - | - | - |
| <b>SB!</b> 5008 (2011 >)   | X | • | • | • | X | - | X |
| <b>SB!</b> 5008 (2018 >)   | X | • | • | • | X | - | X |
| 508 (2011 >)   | X | • | X | • | - | - | - |
|  508 2019 (2018 >)            | X | • | X | • | - | - | - |
|  508 Estate PHEV 2019 (2019 >) | X | • | X | • | - | - | - |
| Bipper Tepee (2008 >)  | X | • | X | • | - | - | - |
| Expert Tepee (2008 >)  | X | • | X | • | X | - | X |
| Partner Combi (2004 - 2010)  | X | X | X | X | - | - | - |
| <b>SB!</b> Partner Teepée (2008 >)   | X | • | X | • | - | - | - |
| RCZ (2011 >)   | X | X | - | X | - | - | - |
| Traveller 2016 (2016 >)  | X | • | • | • | • | • | • |

Polestar





|  |   |   |   |   |   |   |   |
|--|---|---|---|---|---|---|---|
|  2 (2021 >) | X | • | X | • | - | - | - |
|--|---|---|---|---|---|---|---|

Porsche

|  |   |   |   |   |   |   |   |
|--|---|---|---|---|---|---|---|
|  Cayenne (2011 >) | X | • | X | • | - | - | - |
| Cayenne 2017 (2017 >)  | X | • | X | • | - | - | - |
| Cayenne E-Hybrid (2015 >)  | X | • | X | • | - | - | - |
| Macan (2014 >)   | X | • | X | • | - | - | - |
| Panamera (2011 >)  | X | • | - | - | - | - | - |
| Panamera E-Hybrid (2015 >)   | X | • | • | • | - | - | - |

Renault

|                        |   |   |   |   |   |   |   |
|------------------------|---|---|---|---|---|---|---|
| Captur (2015 >)        | X | • | X | • | - | - | - |
| Clio 5dr (2005 - 2013) | X | • | X | • | - | - | - |

|  |   |   |   |   |   |   |   |
|--|---|---|---|---|---|---|---|
| Clio 5dr 2013 (2013 >)   | X | . | X | . | - | - | - |
| Espace (2003 - 2012)   | X | . | . | . | X | - | X |
| Grand Espace (2003 - 2012)   | X | . | . | . | X | - | X |
| Kadjar (2015 >)  | X | . | X | . | - | - | - |
|  Koleos 2018 (2018 >)             | X | . | X | . | - | - | - |
| Laguna Sport Tourer (2008 - 2012)  | X | . | X | . | - | - | - |
|  Megane Hatch 2016 (2016 >)       | X | . | X | . | - | - | - |
|  <b>SB!</b> Megane Hatch (2008 >) | X | . | X | . | - | - | - |
| <b>SB!</b> Megane Hatch (2002 - 2009)  | X | . | X | . | - | - | - |
| Modus (2004 - 2012)  | X | . | X | . | - | - | - |
| <b>SB!</b> Scenic 2003 (2003 - 2009)   | X | . | X | . | - | - | - |
|  <b>SB!</b> Scenic 2017 (2017 >)  | X | . | . | . | - | - | - |
|  <b>SB!</b> Scenic (2009 >)       | X | . | X | . | - | - | - |
| Twingo 2015 (2015 >)   | X | . | - | - | - | - | - |
| Twingo 3dr (2007 >)  | X | X | - | X | - | - | - |





Rover

|                               |   |   |   |   |   |   |   |
|-------------------------------|---|---|---|---|---|---|---|
| 25 / Streetwise (1999 - 2005) | X | X | - | X | - | - | - |
|-------------------------------|---|---|---|---|---|---|---|













SAAB

|                              |   |   |   |   |   |   |   |
|------------------------------|---|---|---|---|---|---|---|
| 93 Sport Wagon (2005 - 2012) | X | . | X | . | - | - | - |
| New 95 (2011 - 2012)         | X | . | X | . | - | - | - |

SEAT

|  |   |   |   |   |   |   |   |
|--|---|---|---|---|---|---|---|
| <b>SB!</b> Alhambra (2010 >)   | X | . | . | . | . | - | . |
| Altea (2004 - 2012)  | X | . | X | . | - | - | - |
|  Arona (2021 >)         | X | . | X | . | - | - | - |
|  Arosa (1997 - 2004)    | X | . | - | - | - | - | - |
|  Ateca 2018 (2018 >)    | X | . | X | . | - | - | - |
|  Cupra Born EV (2022 >) | X | . | X | . | - | - | - |
| Exeo ST (2008 >)   | X | . | X | . | - | - | - |
|  Ibiza 2018 (2018 >)    | X | . | X | . | - | - | - |
| Ibiza HATCH 5 door (2008 - 2013)   | X | . | X | . | - | - | - |
| Leon FR (2006 - 2012)  | X | . | X | . | - | - | - |
| Leon (2000 - 2005)   | X | . | X | . | - | - | - |
| New Toledo (2013 >)  | X | . | X | . | - | - | - |
| mii 5dr (2011 >)   | X | . | X | . | - | - | - |
| Leon 2013 (2013 >)   | X | . | X | . | - | - | - |

Skoda

|  |   |   |   |   |   |   |   |
|--|---|---|---|---|---|---|---|
| Citigo 5dr (2011 >)  | X | . | X | . | - | - | - |
| Citigo 5dr (2012 >)  | X | . | - | - | - | - | - |
|  Enyaq EV (2021 >)      | X | . | X | . | - | - | - |
|  Fabia 2015 (2015 >)    | X | . | X | . | - | - | - |
|  Fabia 2021 (2021 >)    | X | . | X | . | - | - | - |
|  Fabia Hatch (2007 >)   | X | . | X | . | - | - | - |
|  Kamiq (2021 >)         | X | . | X | . | - | - | - |
|  Karoq 2017 > (2017 >)  | X | . | X | . | - | - | - |
|  Kodiaq 2017 > (2017 >) | X | . | X | . | X | - | X |
|  Octavia (2004 - 2012)  | X | . | X | . | - | - | - |
|  Octavia 2020 (2020 >)  | X | . | X | . | - | - | - |
| Octavia Hatch 2013 (2013 >)  | X | . | X | . | - | - | - |
| Rapid (2013 >)   | X | . | X | . | - | - | - |
|  Roomster (2006 >)      | X | . | X | . | - | - | - |
|  Scala (2022 >)         | X | . | X | . | - | - | - |
|  Superb 2015 (2015 >)   | X | . | X | . | - | - | - |
| Superb Combi/Estate (2008 >)   | X | . | X | . | - | - | - |
| Yeti (2009 >)  | X | . | X | . | - | - | - |

Smart

|                                  |   |   |   |   |   |   |   |
|----------------------------------|---|---|---|---|---|---|---|
| For Two Coupe (2007 - 2011)      | X | - | - | - | - | - | - |
| For Two Coupe 2015 (2015 - 2019) | X | - | - | - | - | - | - |
| FourFour 2015 (2015 >)           | X | . | - | - | - | - | - |

Ssangyong

|                            |   |   |   |   |   |   |   |
|----------------------------|---|---|---|---|---|---|---|
| Actyon (2006 - 2011)       | X | . | X | . | - | - | - |
| Korando (2011 >)           | X | . | X | . | - | - | - |
| Musso Pickup 2016 (2016 >) | X | . | - | - | - | - | - |
| Rexton (2014 - 2016)       | X | . | X | . | - | - | - |
| Tivoli (2015 >)            | X | . | X | . | - | - | - |
| Turismo (2014 >)           | X | . | - | - | X | X | X |

Subaru

|                      |   |   |   |   |   |   |   |
|----------------------|---|---|---|---|---|---|---|
| BRZ (2012 >)         | X | . | - | - | - | - | - |
| Forester (2013 >)    | X | . | X | . | - | - | - |
| Impreza 5dr (2007 >) | X | . | X | . | - | - | - |



|  |   |   |   |   |   |   |   |   |
|--|---|---|---|---|---|---|---|---|
| Impreza Hatchback 2013 (2013 >)  | X | ● | X | ● | - | - | - | - |
| Legacy (2012 >)  | X | ● | X | ● | - | - | - | - |
|  Levorg 2014 (2014 >) | X | ● | X | ● | - | - | - | - |
| Outback (2012 >)   | X | ● | X | ● | - | - | - | - |
| XV Hatchback (2011 >)  | X | ● | X | ● | - | - | - | - |

Suzuki









|   |   |   |   |   |   |   |   |   |
|---|---|---|---|---|---|---|---|---|
|  Across (2020 >)           | X | ● | X | ● | - | - | - | - |
| Alto (2009 >)   | X | ● | - | - | - | - | - | - |
|  Baleno 2016 (2016 >)      | X | ● | X | ● | - | - | - | - |
|  Celerio 2016 5dr (2015 >) | X | ● | X | ● | - | - | - | - |
|  Grand Vitara (2005 >)     | X | ● | X | ● | - | - | - | - |
|  Ignis 2016 (2016 >)       | X | ● | - | - | - | - | - | - |
| SX-4 5dr (2006 >)   | X | ● | X | ● | - | - | - | - |
| Splash (2008 >)   | X | ● | X | ● | - | - | - | - |
|  Swift 2017 (2017 >)       | X | ● | X | ● | - | - | - | - |
| Swift Sport 5dr (2011 >)  | X | ● | X | ● | - | - | - | - |
| Vitara 2015 (2015 >)  | X | ● | X | ● | - | - | - | - |

Tesla







|  |   |   |   |   |   |   |   |   |
|--|---|---|---|---|---|---|---|---|
|  Model 3 (2017 >) | X | ● | X | ● | - | - | - | - |
|  Model 3 (2019 >) | X | ● | X | ● | - | - | - | - |
| Model S (2012 >)   | X | ● | X | ● | - | - | - | - |
| Model X (2015 >)   | X | ● | - | - | - | - | - | - |
|  Model Y (2022 >) | X | ● | X | ● | - | - | - | - |

Toyota

|   |   |   |   |   |   |   |   |   |
|---|---|---|---|---|---|---|---|---|
| <b>SB!</b> 2013 Verso (2013 >)  | X | ● | X | ● | - | - | - | - |
| Auris (2007 - 2013)   | X | ● | X | ● | - | - | - | - |
| Auris (2013 >)  | X | ● | X | ● | - | - | - | - |
| Avensis Hatch (2003 - 2011)   | X | ● | X | ● | - | - | - | - |
|  Aygo 2014 (2014 >)  | X | ● | - | - | - | - | - | - |
|  Aygo 2019 (2019 >)  | X | ● | - | - | - | - | - | - |
|  Aygo 3dr (2005 >)  | X | ● | - | - | - | - | - | - |
|   Aygo X 2021 (2021 >)    | X | ● | X | ● | - | - | - | - |
|   C-HR (2017 >)         | X | ● | X | ● | - | - | - | - |
|   Corolla 2018 (2018 >) | X | ● | X | ● | - | - | - | - |
| EZ Mpv (2013 >)   | X | ● | X | ● | - | - | - | - |

|   |   |   |   |   |   |   |   |   |
|---|---|---|---|---|---|---|---|---|
| GT86 (2012 >)   | X | ● | - | - | - | - | - | - |
|  Highlander (2013 >)   | X | ● | X | ● | - | - | - | - |
|  Highlander 2021 (2021 >)  | X | ● | X | ● | - | - | - | - |
| Land Cruiser (2003 - 2009)  | X | ● | X | ● | - | - | - | - |
| Landcruiser (2009 >)  | X | ● | X | ● | - | - | - | - |
| Prius 2 (2004 - 2009)   | X | ● | X | ● | - | - | - | - |
| Prius 3 (2010 >)  | X | ● | X | ● | - | - | - | - |
|  Prius 4 (2016) (2015 >)   | X | ● | X | ● | - | - | - | - |
| Prius PHEV 3 (2015 >)   | X | ● | X | ● | - | - | - | - |
| Prius Plus+ (2012 >)  | X | ● | X | ● | - | - | - | - |
| RAV 4 (2006 - 2012)   | X | ● | X | ● | - | - | - | - |
| RAV4 (2013 >)   | X | ● | X | ● | - | - | - | - |
|  RAV4 2019 (2019 >)  | X | ● | X | ● | - | - | - | - |
|  RAV4 Hybrid (2015 >)  | X | ● | X | ● | - | - | - | - |
| RAV4 Hybrid (2015 >)  | X | ● | X | ● | - | - | - | - |
| <b>SB!</b> Verso (2009 - 2012)  | X | ● | X | ● | - | - | - | - |
| Yaris 2017 > (2017 >)   | X | ● | X | ● | - | - | - | - |
|   Yaris 2019 (2019 >) | X | ● | X | ● | - | - | - | - |
|  Yaris Cross 2022 (2022 >)   | X | ● | X | ● | - | - | - | - |
| Yaris Hatch (2011 >)  | X | ● | X | ● | - | - | - | - |
| Yaris Hatch 5dr (2006 - 2011)   | X | ● | X | ● | - | - | - | - |

VW

|   |   |   |   |   |   |   |   |   |
|---|---|---|---|---|---|---|---|---|
| Amarok Double-Cab (2022 >)  | X | ● | X | ● | - | - | - | - |
|  Arteon 2017 > (2017 >)  | X | ● | X | ● | - | - | - | - |
| Beetle (2012 >)   | X | ● | - | - | - | - | - | - |
| Beetle 1999 (1999 - 2005)   | X | X | - | X | - | - | - | - |
| <b>SB!</b> Caddy Maxilife (2010 >)  | X | ● | X | ● | X | - | X | - |
| E-Golf Hatch Mk7 (2015 >)   | X | ● | X | ● | - | - | - | - |
| E-UP! 5dr (2015 >)  | X | ● | X | ● | - | - | - | - |
| Golf Cabriolet (2009 >)   | X | ● | - | - | - | - | - | - |
| Golf GTE Hatch Mk7 (2015 >)   | X | ● | X | ● | - | - | - | - |
| Golf Hatch (2009 - 2013)  | X | ● | X | ● | - | - | - | - |
| Golf Hatch Mk5 (2004 - 2008)  | X | ● | X | ● | - | - | - | - |
| Golf Hatch Mk7 (2012 >)   | X | ● | X | ● | - | - | - | - |
| Golf Plus (2009 - 2013)   | X | ● | X | ● | - | - | - | - |
|   ID3 EV (2020 >)   | X | ● | X | ● | - | - | - | - |
|   ID4 EV (2021 >) | X | ● | X | ● | - | - | - | - |
|   ID5 EV (2022 >) | X | ● | X | ● | - | - | - | - |
| Jetta (2011 >)  | X | ● | X | ● | - | - | - | - |

① ② ③ ④ ⑤ ⑥ ⑦

|  |                                 |   |   |   |   |   |   |   |
|--|---------------------------------|---|---|---|---|---|---|---|
|  | Lupo (1999 - 2005)              | X | . | . | . | . | . | . |
|  | Multivan Caravelle (2008 >)     | X | . | . | . | . | X | . |
|  | Passat CC (2008 >)              | X | X | . | . | . | . | . |
|  | Passat Estate (2005 - 2011)     | X | X | X | . | . | . | . |
|  | Passat Estate (2011-2015)       | X | X | X | . | . | . | . |
|  | Passat Estate 2015 (2015 >)     | X | X | X | . | . | . | . |
|  | Passat Saloon (2005 - 2011)     | X | X | X | . | . | . | . |
|  | Passat Saloon (2011-2015)       | X | X | X | . | . | . | . |
|  | Passat Saloon 2015 (2015 >)     | X | X | X | . | . | . | . |
|  | Polo 2017 (2017 >)              | X | X | X | . | . | . | . |
|  | Polo 3dr (2009 >)               | X | X | X | . | . | . | . |
|  | Polo 5dr (2009 >)               | X | X | X | . | . | . | . |
|  | Scirocco (2011 >)               | X | . | . | . | . | . | . |
|  | <b>SB!</b> Sharan (2010 >)      | X | . | . | . | . | . | . |
|  | T-Cross (2019 >)                | X | X | X | . | . | . | . |
|  | T-Roc (2017 >)                  | X | X | X | . | . | . | . |
|  | Taigo (2022 >)                  | X | X | X | . | . | . | . |
|  | Tiguan (2008 >)                 | X | X | X | . | . | . | . |
|  | Tiguan 2016 (2016 >)            | X | X | X | . | . | . | . |
|  | Tiguan Allspace 2017 > (2017 >) | X | X | X | . | X | . | X |
|  | Touareg (2012 >)                | X | X | X | . | . | . | . |
|  | Touareg (2003 - 2010)           | X | X | X | . | . | . | . |
|  | Touareg 2018 (2018 >)           | X | X | X | . | . | . | . |
|  | Touran 2016 (2016 >)            | X | . | . | X | . | . | X |
|  | <b>SB!</b> Touran (2010 >)      | X | X | X | X | . | . | X |
|  | UP! 5dr (2015 >)                | X | X | X | . | . | . | . |

Vauxhall

|  |                            |   |   |   |   |   |   |   |
|--|----------------------------|---|---|---|---|---|---|---|
|  | Adam (2013 >)              | X | . | . | . | . | . | . |
|  | Agila (2008 >)             | X | X | X | . | . | . | . |
|  | Ampera (2011 >)            | X | . | . | . | . | . | . |
|  | Antara (2007 >)            | X | X | X | . | . | . | . |
|  | Astra 2010 5dr (2010 >)    | X | X | X | . | . | . | . |
|  | Astra 2015 (2015 >)        | X | X | X | . | . | . | . |
|  | Astra GTC (2011 >)         | X | X | X | . | . | . | . |
|  | Astra Saloon (1998 - 2004) | X | X | X | . | . | . | . |
|  | Corsa 5dr 2015 (2015 >)    | X | X | X | . | . | . | . |
|  | Corsa Hatch 5dr (2006 >)   | X | X | X | . | . | . | . |
|  | Insignia Hatch (2009 >)    | X | X | X | . | . | . | . |
|  | Meriva (2010 >)            | X | X | X | . | . | . | . |

① ② ③ ④ ⑤ ⑥ ⑦

|  |                              |   |   |   |   |   |   |   |
|--|------------------------------|---|---|---|---|---|---|---|
|  | Mokka (2013 >)               | X | . | X | . | . | . | . |
|  | Vectra 2005 (2005 - 2008)    | X | . | X | . | . | . | . |
|  | Viva (2015 >)                | X | . | X | . | . | . | . |
|  | Zafira (2005 >)              | X | . | X | . | . | . | . |
|  | Zafira Tourer (2012 >)       | X | . | X | . | X | . | X |
|  | /Opel Crossland X (2018 >)   | X | . | X | . | . | . | . |
|  | /Opel Grandland X (2019 >)   | X | . | X | . | . | . | . |
|  | /Opel Insignia 2018 (2018 >) | X | . | X | . | . | . | . |

Volvo

|  |                           |   |   |   |   |   |   |   |
|--|---------------------------|---|---|---|---|---|---|---|
|  | C30 (2007 - 2013)         | X | . | . | . | . | . | . |
|  | S40 (2004 - 2012)         | X | . | X | . | . | . | . |
|  | S90 2016 (2016 >)         | X | . | X | . | . | . | . |
|  | V40 (2013 >)              | X | . | X | . | . | . | . |
|  | V40 Cross County (2013 >) | X | . | X | . | . | . | . |
|  | V50 (2004 - 2012)         | X | . | X | . | . | . | . |
|  | V60 (2011 >)              | X | . | X | . | . | . | . |
|  | V60 Plug-In (2015 >)      | X | . | X | . | . | . | . |
|  | V60 (2018 >)              | X | . | X | . | . | . | . |
|  | V90 2016 (2016 >)         | X | . | X | . | . | . | . |
|  | XC40 (2018 >)             | X | . | X | . | . | . | . |
|  | XC60 (2013 >)             | X | . | X | . | . | . | . |
|  | XC60 2017 (2017 >)        | X | . | X | . | . | . | . |
|  | XC70 (2008 >)             | X | . | X | . | . | . | . |
|  | XC90 (2003 - 2015)        | X | . | X | . | . | . | . |
|  | XC90 2016 (2016 >)        | X | . | X | . | X | . | X |



Joie™

Allison Baby UK Ltd,  
Venture Point, Towers Business Park  
Rugeley, Staffordshire, WS15 1UZ

bring the kids™

Share the joy at [joiebaby.com](http://joiebaby.com)

IM-001417D