

# Joie™

0+ (0-13kg)

## i-Snug™ 2

汽車用兒童保護裝置

### 使用說明書

本產品符合安全標準  
CNS 11497 及歐盟標準  
ECE R129 測試和認證  
組裝及使用本產品前  
請先閱讀說明書全文

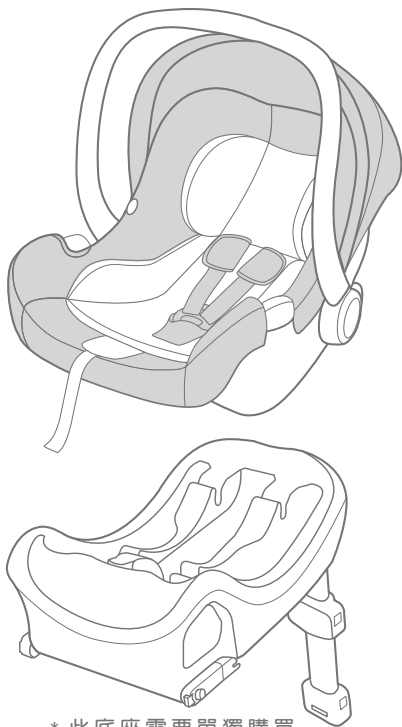

\* 此底座需要單獨購買

# 恭喜您

恭喜您成為 Joie 家族的一員！很高興能與您的寶寶共度行車旅程。乘坐本產品時，您的寶寶享受的是一台高品質和通過安全標準及歐盟安全標準檢測的 O+ 級嬰兒提籃。這台嬰兒提籃適用於體重 13kg (約 1.5 歲) 以下的寶寶。請仔細研讀並依照本說明書的指示操作，如此才能保障並提供您的寶寶一個安全又舒適的行車旅程。

## 請確定

請確定您的汽車有三點式安全帶裝置。依照各種汽車的品牌、年份和型號，安全帶可以有不同的設計和長度。此兒童保護裝置適用符合 CNS 3972 或其他等效標準之三點式安全帶 (不含兩點式安全帶) 之車輛座椅上，因本嬰兒提籃是依標準 CNS 11497 去做測試和認證的。

## 底座

本說明書包含了兒童保護裝置和底座的使用方法。底座還能與某些型號的 Joie 嬰兒提籃配合使用。安裝和使用本產品前，請先閱讀說明書全文。

**！重要：**請仔細閱讀並妥善保存本說明書，以便日後參考。

請依圖示將說明書存放在兒童保護裝置座布下方。



## 目錄

|              |      |
|--------------|------|
| 參照圖示         | 1-12 |
| 中文           |      |
| 警告           | 13   |
| 緊急情況處理       | 15   |
| 產品資訊         | 15   |
| i. 配合底座安裝    | 15   |
| ii. 單獨安裝嬰兒提籃 | 15   |
| 產品組件及各部位名稱   | 18   |
| 安裝注意事項       | 18   |
| 調整把手         | 18   |
| 配合底座安裝       | 18   |
| 頭靠及肩帶高度調整    | 20   |
| 寶寶乘坐         | 20   |
| 單獨安裝嬰兒提籃     | 21   |
| 配合手推車使用      | 21   |
| 拆卸遮陽篷和座墊     | 22   |
| 保養維護與保固      | 23   |

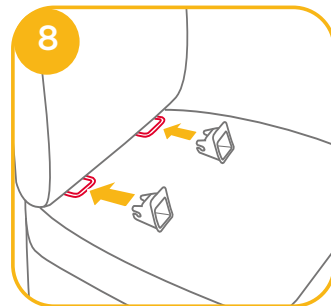
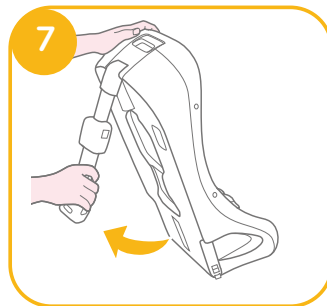
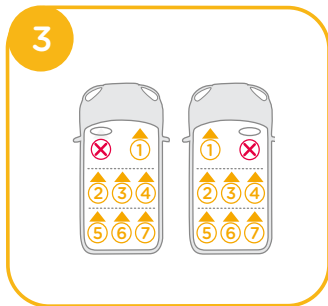
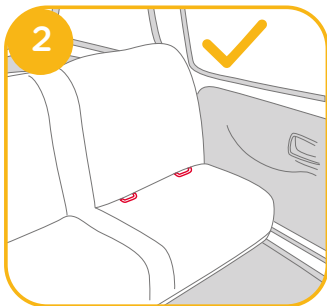
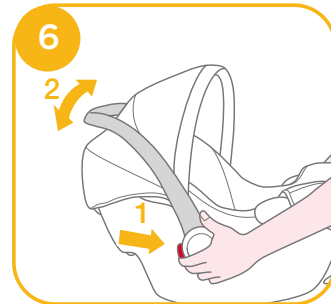
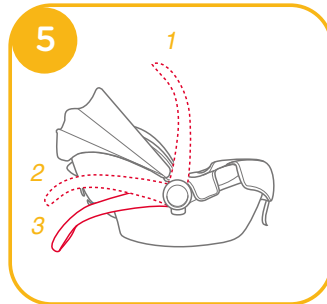
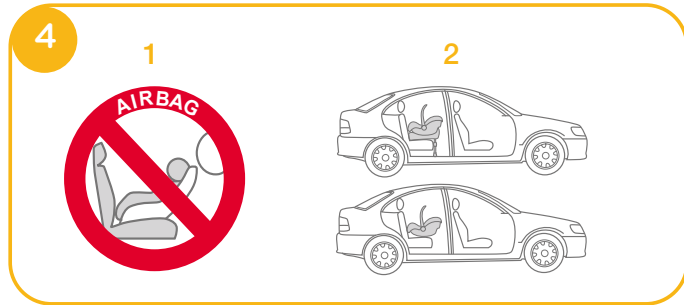
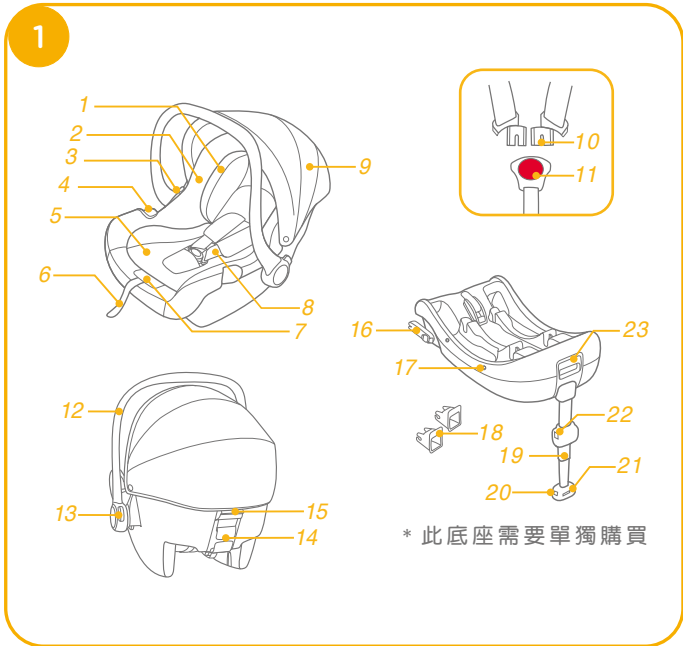

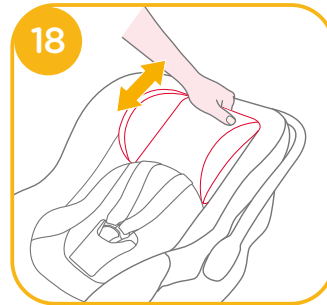
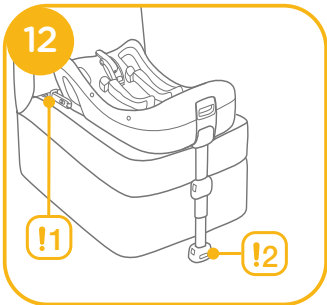
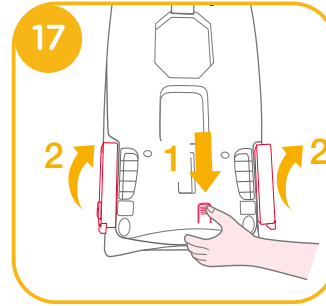
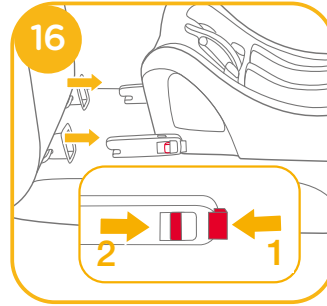
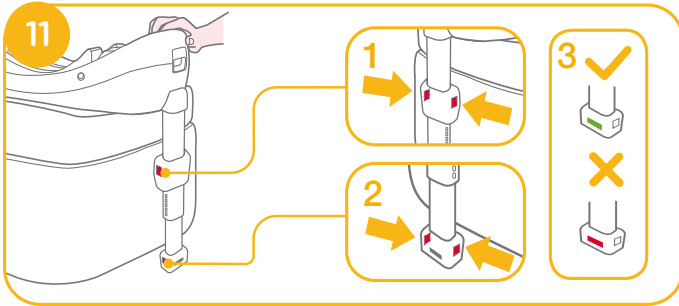
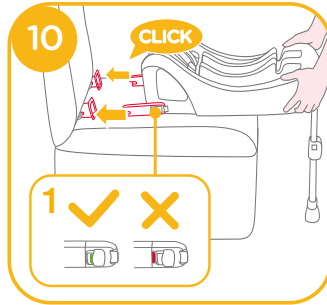
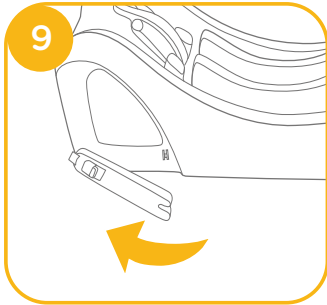

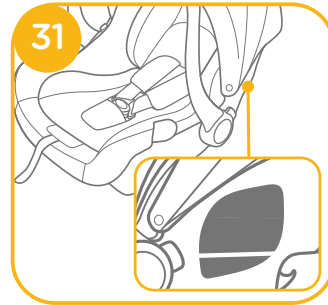
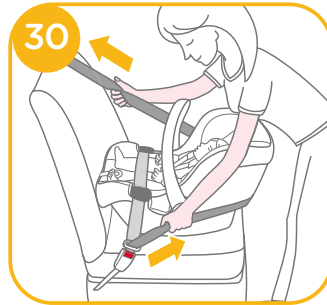
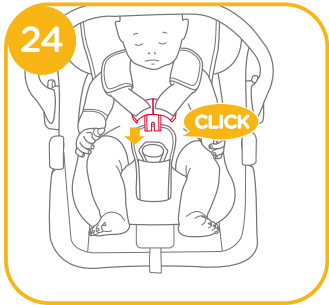
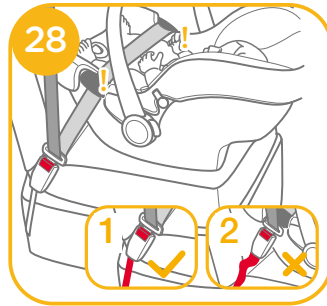
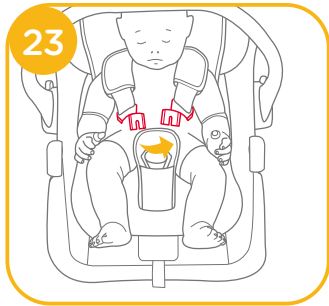
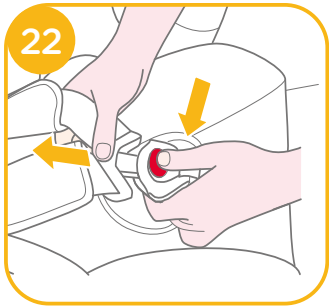
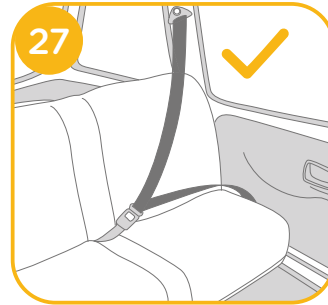
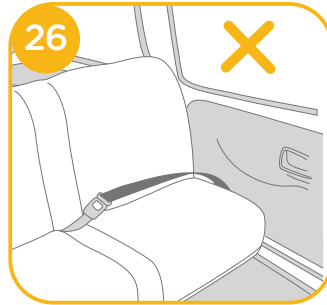
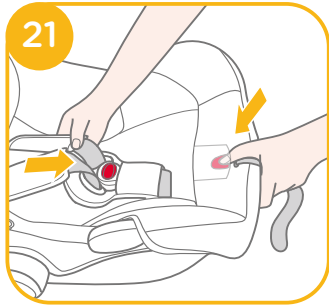

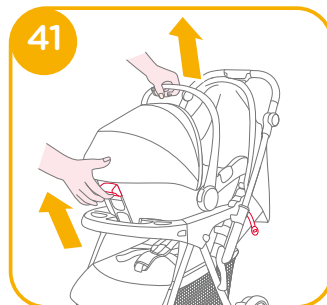
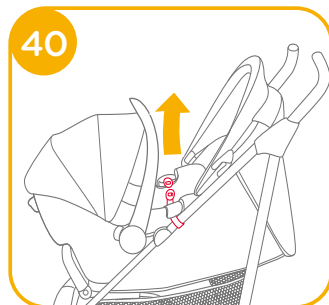
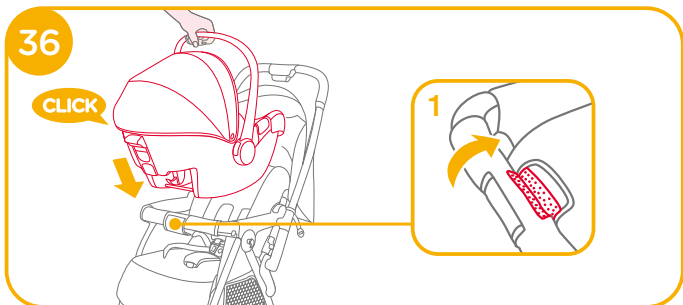
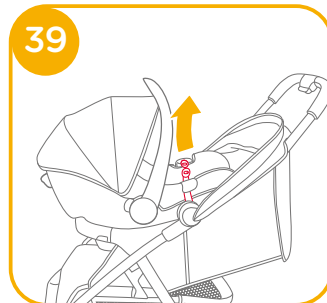
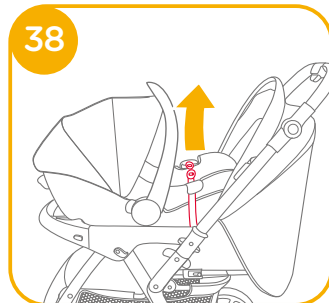
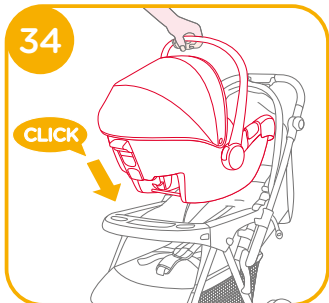
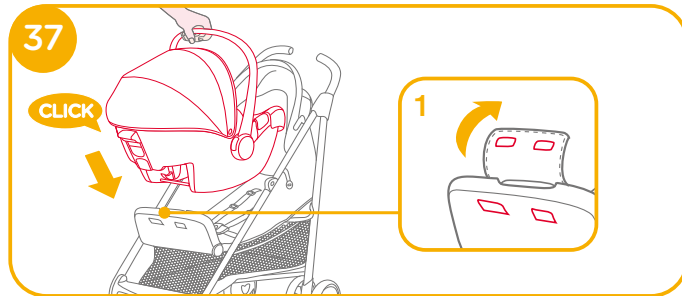
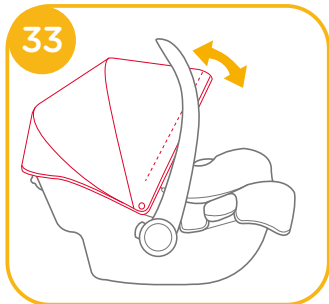
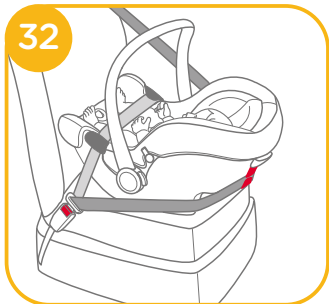

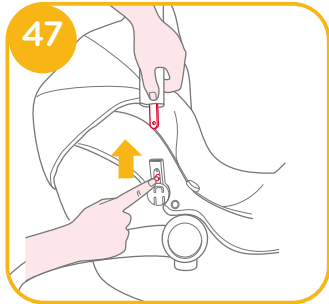
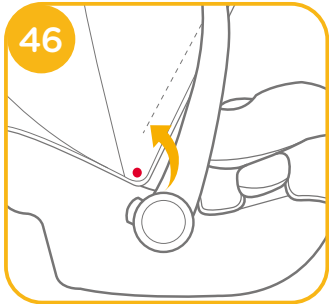
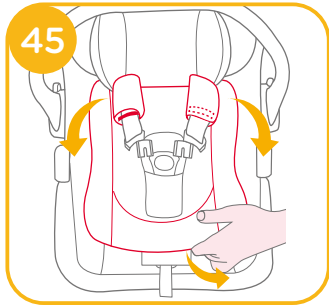
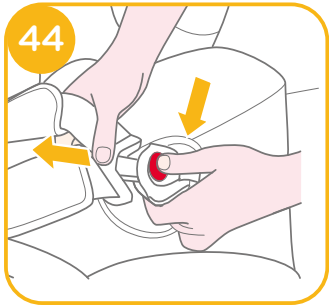
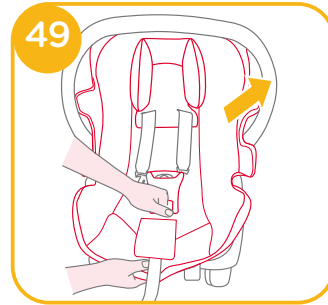
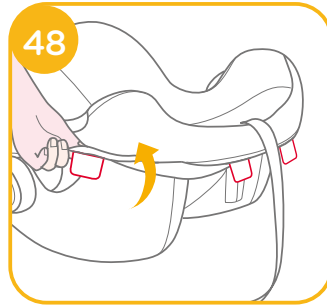
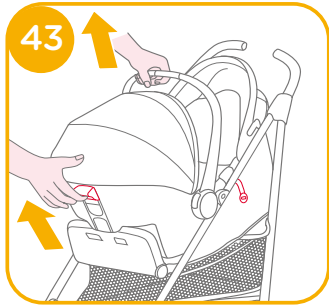
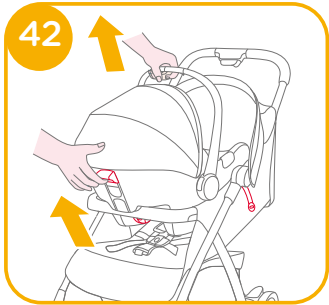

# 警告

- ! 沒有任何嬰兒提籃可以保證100%遠離傷亡，然而正確的使用本嬰兒提籃可以降低寶寶傷亡的機率。
- ! 本嬰兒提籃適用於體重13kg以下的寶寶。
- ! 任何束縛兒童保護裝置至車輛之織帶應束緊，任何束縛兒童之織帶應根據兒童身體進行調節，且此織帶不應扭曲。
- ! 將您的寶寶放入嬰兒提籃後，必須正確的扣合及使用嬰兒提籃安全帶。
- ! 本兒童保護裝置若於意外中遭受劇烈撞擊後，不可繼續使用，應立即更換兒童保護裝置。意外可能導致兒童保護裝置產生潛在危險。
- ! 請勿在兒童保護裝置上進行未經驗證許可之改裝或增加其他裝置以及未依兒童保護裝置製造商提供之安裝說明使用，以免造成受傷或死亡。
- ! 請讓座椅遠離日光，以免產品溫度過高對兒童的皮膚造成傷害。
- ! 在無人照料下，不得讓兒童留在兒童保護裝置內。
- ! 任何行李或其他可能在碰撞中造成傷害之物品應適當牢固。
- ! 本嬰兒提籃如有任何損壞或零件缺失時，請勿繼續使用。
- ! 請勿讓您的寶寶穿著過大的衣物，所穿的衣物必須能讓嬰兒提籃的安全帶適當而安全地扣在寶寶兩腿之間。
- ! 請勿將未固定的嬰兒提籃留在車內，以免緊急剎車時，傷害到其他乘客。若不經常使用嬰兒提籃時，請將其搬離汽車座椅。
- ! 請勿在未閱讀或了解本嬰兒提籃說明書及汽車說明書之前，使用或安裝本嬰兒提籃。
- ! 嚴禁將本兒童保護裝置置於設有正面氣囊的座位上。
- ! 請勿使用二手嬰兒提籃或來歷不明的嬰兒提籃，因為它們可能存在危害寶寶安全的潛在危險。

- ! 不可使用繩子等其他物件代替汽車安全帶，以避免兒童被粗細繩索意外勒住。
- ! 當本嬰兒提籃沒有座布時，請勿使用。
- ! 請勿使用非本製造商推薦的座布，否則會影響兒童安全座椅的總體性能。
- ! 本兒童保護裝置僅能安裝到有固定靠背的汽車座椅上，不能安裝到靠背無法固定，以致靠背向前折疊或自由轉動的汽車座椅上。
- ! 請勿使用其他廠商的小座墊或底座來配合本嬰兒提籃使用。如需更換配件時，請與代理商聯繫。
- ! 請勿放置任何物品在兒童保護裝置下方。發生撞擊時，此物品會飛出，導致織帶變鬆，並影響其他乘客的安全。
- ! 本兒童保護裝置僅能在鋪滿墊子且沒有尖銳物品的汽車座椅上使用。
- ! 必須小心定位和安裝兒童保護裝置，以免被可移動車輛座椅或車門卡住。
- ! 使用本產品前，請取掉PE袋和包裝材料，並放到嬰兒觸摸不到的地方。
- ! 長期不使用嬰兒提籃時，請將其搬離汽車座椅。
- ! 有關零件更換或維修問題，請向代理商查詢。
- ! 不管在哪種狀況下使用，把寶寶放入提籃後，請一直為寶寶繫好安全帶，以免寶寶從提籃內跌出。
- ! 手提嬰兒提籃前，請確認寶寶已繫好安全帶，且把手固定於直立段位。
- ! 請勿將嬰兒提籃置於桌子、椅子等高於地面的平台上。
- ! 不可使用除使用說明書中所標注以外之其他受力點。
- ! 請勿將任何物品置於支撐腳附近。



## 緊急情況處理

遇緊急事故時，需將安全帶剪斷，迅速將乘坐的嬰兒移離現場。

## 產品資訊

### i. 配合底座安裝

#### 嬰兒提籃配合i-Base 2使用ISOFIX系統安裝

1. 此為ISOFIX兒童保護裝置，符合安全標準CNS 11497。用於裝有ISOFIX固定器系統之車輛座椅。
2. 本兒童保護裝置安裝適用於車輛配有經認可之ISOFIX安裝位置。（請參照車輛使用手冊）請依此兒童保護裝置之種類及ISOFIX尺度等級，安裝於附有ISOFIX固定器系統之車輛座椅上。
3. 此兒童保護裝置使用之質量等級為：0+，ISOFIX尺度等級為：C·D。

#### 嬰兒提籃配合i-Base 2底座安裝

1. 嬰兒提籃與底座組合構成“半通用型”兒童保護裝置。適用車輛座椅位置請參考紙箱及說明書上的車型適配資訊。
2. 其他車輛型式亦有可能適用此兒童保護裝置。若有疑問，請洽兒童保護裝置製造商或代理商。

### ii. 單獨安裝嬰兒提籃

1. 此為“通用型”兒童保護裝置，符合安全標準CNS 11497。其適用大部分（並非全部）之車輛座椅。

2. 若車輛製造商在車主使用手冊中述明其可適用此質量等級之“通用型”兒童保護裝置，則本裝置可安裝於該車輛上。
3. 此兒童保護裝置歸類為“通用型”，比其他無標示此注意事項之兒童保護裝置可適用於較多車輛。
4. 若有疑問，請洽兒童保護裝置製造商或代理商。

#### Allison Baby UK Ltd.

Venture Point, Towers Business Park,  
Rugeley, Staffordshire, WS15 1UZ  
www.joiebaby.com

|             |                               |
|-------------|-------------------------------|
| <b>產品名稱</b> | 汽車用兒童保護裝置                     |
| <b>產品型號</b> | C1817,C1817C                  |
| <b>適用範圍</b> | 13kg(約1.5歲)以下的寶寶              |
| <b>主要材質</b> | 塑膠、五金、布                       |
| <b>質量等級</b> | 0+                            |
| <b>淨重</b>   | 3.3kg                         |
| <b>產品尺寸</b> | 660mmx440mmx570mm             |
| <b>製造日期</b> | 詳見產品上貼紙日期(年/月/日)              |
| <b>專利號碼</b> | 專利申請中                         |
| <b>原產地</b>  | 中國                            |
| <b>委製商</b>  | 巧兒宜國際股份有限公司                   |
| <b>進口商</b>  | 巧兒宜國際股份有限公司                   |
| <b>地址</b>   | 台北市內湖區瑞光路431號2樓               |
| <b>電話</b>   | 02-27973000                   |
| <b>統一編號</b> | 52603333                      |
| <b>代理商</b>  | 奇哥股份有限公司 Chickabiddy Co., Ltd |
| <b>地址</b>   | 台北市南京東路四段186號5樓               |
| <b>服務專線</b> | 0800-001-256/02-25781188      |
| <b>統一編號</b> | 04222671                      |
| <b>網址</b>   | www.chick.com.tw              |

## 安裝模式選擇

| 安裝圖示  | 適用範圍                 |
|---|----------------------|
|  | 13kg(約1.5歲)<br>以下的寶寶 |
|  | 13kg(約1.5歲)<br>以下的寶寶 |
|  | 13kg(約1.5歲)<br>以下的寶寶 |

## 產品組件及各部位名稱

- |        |        |        |            |
|--------|--------|--------|------------|
| 圖 1.1  | 頭靠     | 圖 1.13 | 把手調整按鈕     |
| 圖 1.2  | 座墊     | 圖 1.14 | 後向卡槽       |
| 圖 1.3  | 推車釋鎖按鈕 | 圖 1.15 | 推車釋鎖手把     |
| 圖 1.4  | 側面卡槽   | 圖 1.16 | ISOFIX 連接器 |
| 圖 1.5  | 小座墊    | 圖 1.17 | 汽車椅指示器     |
| 圖 1.6  | 調整織帶   | 圖 1.18 | ISOFIX 導向器 |
| 圖 1.7  | 調整按鈕   | 圖 1.19 | 支撐腳        |
| 圖 1.8  | 肩帶     | 圖 1.20 | 支撐腳調整按鈕 A  |
| 圖 1.9  | 遮陽篷    | 圖 1.21 | 支撐腳指示器     |
| 圖 1.10 | 安全扣-插扣 | 圖 1.22 | 支撐腳調整按鈕 B  |
| 圖 1.11 | 安全扣-母扣 | 圖 1.23 | 嬰兒提籃釋鎖按鈕   |
| 圖 1.12 | 把手     |        |            |

請確認產品組件是否有遺漏，如有遺漏，請聯繫銷售商。

## 安裝注意事項

見圖28圖38圖4

## 調整把手

把手有3個段位可供調整(圖5)

！ 手提、置於汽車內或置於推車上時，請用段位1

調整把手位置時，先按壓兩邊的把手調整按鈕(圖6.1)，將把手旋轉到適合段位後再鬆開把手調整按鈕(圖6.2)

## 配合底座安裝

1. 展開底座支撐腳(圖7)
2. 將ISOFIX導向器固定到ISOFIX固定點上(圖8)。ISOFIX導向器既可防止汽車座椅表面被刮破，又可為ISOFIX連接器導向。

- 將ISOFIX連接器翻轉180度至連接器指向ISOFIX導向器方向(圖9)
  - 將ISOFIX連接器與ISOFIX導向器對齊後，將ISOFIX連接器插入ISOFIX固定點上(圖10)
    - ！請確定左右兩邊的ISOFIX連接器都已牢固固定到ISOFIX固定點上。且兩個ISOFIX連接器上的指示器應顯示綠色(圖10.1)
    - ！同時往外拉兩邊的ISOFIX連接器，以確保ISOFIX連接器已固定。
  - 把底座置於合適的汽車座椅，將支撐腳延伸到地面(圖11)。支撐腳正確安裝時，支撐腳指示器顯示綠色，否則顯示紅色(圖11.3)
    - ！支撐腳有多個調整段位，支撐腳指示器顯示紅色時，表明支撐腳處於錯誤段位。請重新操作至正確位置為止。
    - ！向下按壓底座，以確定支撐腳正確固定。
    - ！按壓支撐腳釋鎖按鈕可將支撐腳向上調整。
- 底座安裝好後如圖12所示。
- ！ISOFIX連接器須鎖定在ISOFIX固定點上(圖12.1)
  - ！底座支撐腳須正確固定，並以綠色顯示(圖12.2)
  - ！請將嬰兒提籃安裝到車輛後座上，然後將寶寶放入嬰兒提籃內。
- 將嬰兒提籃卡入底座內(圖13)，如果提籃固定正確，提籃指示器將顯示綠色(圖14)
    - ！將嬰兒提籃向上拉，以確保提籃已正確固定於底座內。
  - 釋鎖嬰兒提籃時，按壓提籃釋鎖按鈕(圖15.1)，同時將提籃往上提即可(圖15.2)
  - 移除底座時，按壓連接器上的第二道安全鎖(圖16.1)與釋鎖按鈕(圖16.2)，然後將底座往外拉即可(圖16)
  - 按壓ISOFIX釋鎖按鈕收合ISOFIX(圖17)

## 頭靠及肩帶高度調整

- 頭靠可根據寶寶的身高進行調整(圖18)
- 檢查肩帶有調節至適當的高度。
  - ！無論頭靠在哪個位置，肩帶須穿過最接近寶寶肩膀位置的肩帶孔(圖19)
  - ！若肩帶位置不合適，意外發生時可能造成寶寶被拋出嬰兒提籃的危險。

## 寶寶乘坐

### 提示

- 小座墊的作用是為了保護寶寶，0-6個月的寶寶必須使用小座墊。
- 使用小座墊前，請裝上填充物(圖20)



如果肩部空間太小，可將肩靠移除

- 按壓座椅前端的調整按鈕，並向外拉肩帶，以完全調鬆肩帶(圖21)
- 按壓紅色按鈕，鬆開安全扣(圖22)
- 將寶寶放入座椅，並扣合安全扣(圖23&圖24)
- 向外拉調整織帶，以調緊肩帶(圖25)
  - ！請注意，寶寶與肩帶之間須有一個手掌的間距。

## 單獨安裝嬰兒提籃

！請勿將此嬰兒提籃安裝在二點式安全帶的汽車座椅上，由於此種安全帶功能不完善，使用是非常危險的(圖26)

！此產品適合安裝在設置有三點式安全帶的汽車座椅上(圖27)

1. 將嬰兒提籃置於合適的汽車座椅上，拉出汽車安全帶後扣好汽車安全扣，再將汽車腰帶卡入嬰兒提籃兩邊的卡槽內(圖28)

！汽車安全帶母扣段若太長，汽車安全帶無法綁緊不能使用(圖28.2)

2. 將汽車肩帶卡入嬰兒提籃後面的卡槽內(圖29)

3. 用力拉緊汽車安全帶，使汽車安全帶緊實的繫住嬰兒提籃(圖30)

4. 當提籃安裝後，提籃上的水平線必須與地面水平(圖31)

！盡力拉緊汽車安全帶，並確定汽車安全帶沒有鬆弛或扭曲。

！組裝提籃後，始終檢查車輛安全帶安裝路徑正確且扣具有扣合(圖32)

## 配合手推車使用

本嬰兒提籃可搭配具有扶手、餐盤或小腿靠的Joie手推車使用。

！購買前，請確定您的手推車可與本嬰兒提籃搭配使用。

！本產品僅供一位寶寶使用。

！安裝嬰兒提籃前請給手推車剎車。

！請確定，用於固定嬰兒提籃的部件已牢固固定於手推車上。

！請將手推車靠背調至最平躺段位。

請依以下步驟將嬰兒提籃安裝到手推車上：

1. 將嬰兒提籃置於手推車內，以使嬰兒提籃卡鉤卡到扶手、餐盤或小腿靠邊緣，嬰兒提籃將自動扣合到位(圖33&圖34&圖35&圖36&圖37)

！扶手有布套時，請先揭開布套上的粘扣帶(圖36.1)

！對於有特殊小腿靠的手推車，請先將小腿靠調至最直立位置，並揭開布套(圖37.1)

2. 用手推車兩側的固定織帶固定嬰兒提籃(圖38&圖39&圖40)

！將提籃往上提，確保提籃已正確固定。

移除嬰兒提籃時，先從嬰兒提籃上取下固定織帶，按壓嬰兒提籃釋鎖把手(圖41&圖42&圖43)

## 拆卸遮陽篷和座墊

見圖44-圖49

反向操作即可組裝座布。

## 保養維護與保固

- ! 小座墊支撐塊拆除後，請將其存放於寶寶無法接觸到的地方。
- ! 請以30度以下水溫清洗。
- ! 請勿使用熨斗熨燙。
- ! 請勿使用漂白劑及乾洗。
- ! 請勿使用未經稀釋的中性清潔劑、汽油或其他有機溶劑清洗本兒童保護裝置，否則可能對約束系統造成損壞。
- ! 請勿大力扭乾，過分大力扭乾可能留下皺褶。
- ! 請於陰涼處鋪平晾乾。
- ! 當長時間不使用本兒童安全座椅時，請將本兒童安全座椅從汽車座椅上拆除，並存放於陰涼處及寶寶不易接觸的地方。

### 延長保固服務

請於購買起一個月內至奇哥官網進行登錄，登錄成功後即享有商品延長一年保固服務。



## 汽車安裝資訊



1. 其他車輛型式亦有可能適用此兒童保護裝置。以下車型主要為歐洲銷售車款安裝適配性資料。若有疑問，請洽兒童保護裝置製造商或代理商。
2. 後向使用時，嚴禁將本兒童安全座椅置於有正面空氣囊的座位上。
3. 兒童保護裝置不能安裝於前座之位置。
4. ● 表示汽車座椅可安裝本兒童保護裝置。
5. ✕ 表示汽車座椅不可安裝本兒童保護裝置。
6. ⚡ 表示用電或其它混合驅動的車輛。
7.  表示符合i-size的車輛。
8. SB! 表示汽車地板下有儲存盒。
9. 將此座椅安裝在地板下有儲存盒的汽車上時，請參考汽車使用說明書或聯繫代理商。  
! 表示汽車地板下儲物盒的位置。
10. 如果您的汽車品牌未被列入本說明書或未用“●”或“✕”進行標示，請查閱您的汽車手冊或聯絡兒童約束系統製造商，以進一步了解相關資訊。





## Belt Fit

① ② ③ ④ ⑤ ⑥ ⑦





### Alfa Romeo

|                        |   |   |   |   |   |   |   |
|------------------------|---|---|---|---|---|---|---|
| Giulia (2018>)         | X | • | X | • | - | - | - |
| Guilietta (2018>)      | X | • | X | • | - | - | - |
| Guilietta (2010>)      | X | • | X | • | - | - | - |
| MiTo (2018>)           | X | • | - | • | - | - | - |
| MiTo (2009>)           | X | • | - | • | - | - | - |
| Stelvio (2018>)        | X | • | X | • | - | - | - |
| 156 Sportswagon (2005) | X | • | X | • | - | - | - |
| 159 (2011)             | X | • | X | • | - | - | - |

### Audi

|   |   |   |   |   |   |   |   |
|---|---|---|---|---|---|---|---|
| A1 (2011>)  | X | • | X | • | - | - | - |
| A1 Sportback (2012>)  | X | • | X | • | - | - | - |
| A1 Sportback (2018>)  | X | • | X | • | - | - | - |
|  A3 e-Tron Sportback (2015>) | X | • | X | • | - | - | - |
| A3 Hatch (2012>)  | X | • | X | • | - | - | - |
| A3 S3 (2012>)   | X | • | X | • | - | - | - |
| A3 (2018>)  | X | • | X | • | - | - | - |
| A3/S3 Saloon (2014>)  | X | • | X | • | - | - | - |
| A3 Saloon (2018>)   | X | • | X | • | - | - | - |
| A3 (2004 - 2011)  | X | • | X | • | - | - | - |
|  A3 (1996 - 2003)            | X | • | X | • | - | - | - |
|  A4 Avant (2016>)            | X | • | X | • | - | - | - |
| A4/S4 (2015>)   | X | • | X | • | - | - | - |
| A4/S4 (2009>)   | X | • | X | • | - | - | - |
| A4 (2005 - 2009)  | X | • | X | • | - | - | - |
| A4/S4 Avant (2008 - 2016)   | X | • | X | • | - | - | - |
| A4/S4 Saloon (2008 - 2016)  | X | • | X | • | - | - | - |
|  A4 Saloon (2018>)           | X | • | X | • | - | - | - |
| A4 (2015>)  | X | • | X | • | - | - | - |
| A4 Allroad (2008 - 2016)  | X | • | X | • | - | - | - |
| A5 (2018>)  | X | • | - | • | - | - | - |
| A5 (2016>)  | X | • | X | • | - | - | - |
| A5 (2007>)  | X | • | X | • | - | - | - |
| A5 Cabriolet (2018>)  | X | • | X | • | - | - | - |
| A5/S5 Coupe (2016>)   | X | • | - | • | - | - | - |
| A5 Coupe (2006 - 2016)  | X | • | - | • | - | - | - |
| A5 Coupe (2018>)  | X | • | - | • | - | - | - |
| A5/S5 Sportback (2017>)   | X | • | X | • | - | - | - |



① ② ③ ④ ⑤ ⑥ ⑦

|  |   |   |   |   |   |   |   |
|--|---|---|---|---|---|---|---|
| A5/S5 Sportback (2007 - 2016)  | X | • | X | • | - | - | - |
| A5 Sportback (2007>)   | X | • | X | • | - | - | - |
| A6 Allroad (2016>)   | X | • | X | • | - | - | - |
| A6 (2011>)   | X | • | X | • | - | - | - |
| A6 Allroad (2011>)   | X | • | X | • | - | - | - |
| A6 Avant (2011>)   | X | • | X | • | - | - | - |
| A6/S6 (2011>)  | X | • | X | • | - | - | - |
| A6/S6 (2016>)  | X | • | X | • | - | - | - |
| A7 Sportback (2018>)   | X | • | X | • | - | - | - |
| A7/S7 Sportback (2016>)  | X | • | X | • | - | - | - |
| A7 Sportback (2011>)   | X | • | X | • | - | - | - |
| A8/S8 (2011>)  | X | • | X | • | - | - | - |
| A8 (2011>)   | X | • | X | • | - | - | - |
|  A8 (2018>)       | X | • | X | • | - | - | - |
|  Q2 (2016>)       | X | • | X | • | - | - | - |
| Q3 (2013>)   | X | • | X | • | - | - | - |
| Q3 (2018>)   | X | • | X | • | - | - | - |
| Q5/SQ5 (2012 - 2016)   | X | • | X | • | - | - | - |
| Q5 (2008 - 2012)   | X | • | X | • | - | - | - |
| Q5 (2018>)   | X | • | X | • | - | - | - |
|  Q7 (2006 - 2016) | X | • | X | • | - | - | - |
|  Q7/SQ7 (2015>)   | X | • | X | • | X | - | X |
| S1 (2014)  | X | • | X | • | - | - | - |
| TT Coupe Sport (2015>)   | X | • | X | • | - | - | - |
| TT Coupe (2012>)   | X | • | X | • | X | - | X |
| TT Coupe (2006>)   | X | • | - | • | - | - | - |

### Bentley

|                                 |   |   |   |   |   |   |   |
|---------------------------------|---|---|---|---|---|---|---|
| Continental Flying Spur (2005>) | X | • | X | • | - | - | - |
| Continental GT (2003 - 2012)    | X | • | - | • | - | - | - |
| Continental GTC (2005 - 2012)   | X | • | - | • | - | - | - |
| Mulsanne (2010>)                | X | • | X | • | - | - | - |
| Mulsanne (2012>)                | X | • | X | • | - | - | - |

BMW

|  |   |   |   |   |   |   |   |
|--|---|---|---|---|---|---|---|
| 1 Series F20 (2011>)   | X | . | X | . | - | - | - |
| 1-Series 5dr (2004 - 2011)   | X | . | X | . | - | - | - |
| 1-Series Convertible (2008 - 2015)   | X | . | - | . | - | - | - |
| 1-Series Coupe (2008 - 2015)   | X | . | - | . | - | - | - |
| 2-Series AC-T (2015>)  | X | . | X | . | - | - | - |
| 2-Series Coupe (2014>)   | X | . | - | . | - | - | - |
| 2-Series Gran Tourer (2018>)   | X | . | X | . | - | - | - |
| 3-GT (2013>)   | X | . | X | . | - | - | - |
| 3 Series F30 (2012>)   | X | . | X | . | - | - | - |
| 3-Series (2005 - 2011)   | X | . | - | . | - | - | - |
| 3-Series Coupe (2007- 2014)  | X | . | - | . | - | - | - |
| 3-Series M Sport (2018>)   | X | . | - | . | - | - | - |
| 4-Series Gran Coupe (2014>)  | X | . | X | . | - | - | - |
| 5-GT (2010>)   | X | . | X | . | - | - | - |
| 5-Series (2008 - 2010)   | X | . | X | . | - | - | - |
| 5-Series (2011>)   | X | . | X | . | - | - | - |
| 5-Series M (2005 - 2011)   | X | . | X | . | - | - | - |
| 5-Series Saloon (2011>)  | X | . | X | . | - | - | - |
| 5-Series Saloon (2003 - 2010)  | X | . | X | . | - | - | - |
| 5-Series Touring (2011>)   | X | . | X | . | - | - | - |
| 5-Series Touring (2003 - 2010)   | X | . | X | . | - | - | - |
| 6-Series Coupe (2Dr) (2011>)   | X | . | - | . | - | - | - |
| 6-Series Convertible (2011>)   | X | . | - | . | - | - | - |
| 6-Series Gran Coupe (4Dr) (2011>)  | X | . | X | . | - | - | - |
| 6-GT (2018>)   | X | . | X | . | - | - | - |
| 7-Series (2010>)   | X | . | X | . | - | - | - |
| 7-Series (2016>)   | X | . | X | . | - | - | - |
| M5 (2011)  | X | . | X | . | - | - | - |
| M Sport Saloon (2018>)   | X | . | X | . | - | - | - |
|  i3 (2014>)       | X | . | - | . | - | - | - |
|  X1 (2009 - 2015) | X | . | X | . | - | - | - |
| X1 (2016>)   | X | . | X | . | - | - | - |
| X2 (2018>)   | X | . | X | . | - | - | - |
| X3 F25 (2011>)   | X | . | X | . | - | - | - |
| X4 (2014>)   | X | . | X | . | - | - | - |
| X5 (2007- 2014)  | X | . | X | . | X | - | X |
| X5 (2015>)   | X | . | X | . | X | - | X |
| X5 (2018>)   | X | . | X | . | X | - | X |
| X5 M (2018>)   | X | . | X | . | X | - | X |

Cadillac

|                          |   |   |   |   |   |   |   |
|--------------------------|---|---|---|---|---|---|---|
| X6 (2008>)               | X | . | X | . | - | - | - |
| X6 (2015>)               | X | . | - | . | - | - | - |
| X6 M (2008>)             | X | . | - | . | - | - | - |
| BLS Saloon (2006 - 2011) | X | . | X | . | - | - | - |
| CTS (2007)               | X | . | X | . | - | - | - |

Chevrolet

|                     |   |   |   |   |   |   |   |
|---------------------|---|---|---|---|---|---|---|
| Aveo 5 door (2012>) | X | . | X | . | - | - | - |
| Captiva (2007>)     | X | . | X | . | - | - | - |
| Camaro (2011)       | X | . | X | . | - | - | - |
| Cruze (2009>)       | X | . | X | . | - | - | - |
| Cruze (2012>)       | X | . | X | . | - | - | - |
| Epica (2006)        | X | . | X | . | - | - | - |
| HHR (2009)          | X | . | X | . | - | - | - |
| Kalos (2002)        | X | . | X | . | - | - | - |
| Lacetti (2004)      | X | . | X | . | - | - | - |
| Malibu (2012)       | X | . | X | . | - | - | - |
| Matiz (2005 - 2009) | X | . | X | . | - | - | - |
| Matiz (2006)        | X | . | X | . | - | - | - |
| Nubira (2009)       | X | . | X | . | - | - | - |
| Orlando (2011>)     | X | . | X | . | - | - | - |
| Spark (2012>)       | X | . | X | . | - | - | - |
| Traxx (2013>)       | X | . | X | . | - | - | - |
| Volt (2011>)        | X | . | - | . | - | - | - |

Chrysler

|                       |   |   |   |   |   |   |   |
|-----------------------|---|---|---|---|---|---|---|
| 300C (2012>)          | X | . | X | . | - | - | - |
| Delta (2011>)         | X | . | X | . | - | - | - |
| Delta (2007>)         | X | . | X | . | - | - | - |
| Dodger Avenger (2007) | X | . | X | . | - | - | - |
| Dodger Caliber (2006) | X | . | X | . | - | - | - |
| Dodger Journey (2009) | X | . | - | . | - | - | - |
| Dodger Nitro (2006)   | X | . | X | . | - | - | - |
| Dodge Ram (2008)      | X | . | - | . | - | - | - |

① ② ③ ④ ⑤ ⑥ ⑦

|                       |   |   |   |   |   |   |   |
|-----------------------|---|---|---|---|---|---|---|
| Pacifica (2008)       | X | • | X | • | - | - | - |
| PT Cruiser (2010)     | X | • | X | • | - | - | - |
| Sebring (2007)        | X | • | X | • | - | - | - |
| Grand Voyager (2008>) | X | • | - | • | X | X | X |
| Voyager (2007)        | X | • | X | • | - | - | • |
| Ypsilon (2011>)       | X | • | X | • | - | - | - |

## Citroen

|   |   |   |   |   |   |   |   |
|---|---|---|---|---|---|---|---|
| Berlingo II (2008>)   | X | • | X | • | - | - | - |
| SB! Berlingo Multispace (2007>)   | X | ! | X | ! | X | - | X |
| Berlingo Multispace (2009)  | X | X | • | X | - | - | - |
| C1 (2005 - 2015)  | X | • | - | • | - | - | - |
| C1 (2015>)  | X | • | - | • | - | - | - |
| C2 (2004)   | X | • | X | • | - | - | - |
| C3 5Dr (2005 - 2009)  | X | • | X | • | - | - | - |
| C3 5Dr (2009 - 2016)  | X | • | X | • | - | - | - |
| SB! C3 5Dr (2017>)  | X | ! | X | ! | - | - | - |
| SB! C3 Picasso (2009>)  | X | ! | X | ! | - | - | - |
| C4 (2010>)  | X | • | X | • | - | - | - |
| SB! C4 G-Picasso (2007 - 2013)  | X | ! | • | ! | X | - | X |
| SB! C4 Picasso (2007 - 2014)  | X | ! | X | ! | X | X | X |
| SB! C4 Picasso (2014>)  | X | ! | X | ! | X | X | X |
| SB! C4 Picasso (2017>)  | X | ! | • | ! | X | - | X |
|  C4-Cactus (2015>) | X | • | X | • | - | - | - |
| C5 (2005 - 2008)  | X | • | X | • | - | - | - |
| C5 (2006 - 2010)  | X | • | X | • | - | - | - |
| C5 Saloon (2008>)   | X | • | X | • | - | - | - |
| C5 Tourer (2008>)   | X | • | X | • | - | - | - |
| C-Crosser (2007 - 2013)   | X | • | X | • | - | - | - |
| DS3 (2010>)   | X | • | X | • | - | - | - |
| DS3 Cabrio (2016>)  | X | • | X | • | - | - | - |
| DS4 (2011>)   | X | • | X | • | - | - | - |
| DS5 (2012>)   | X | • | X | • | - | - | - |
| Evasion (2002)  | X | • | X | • | - | X | • |
| Jumpy (2007 - 2012)   | X | • | X | • | X | X | X |
| Nemo (2008>)  | X | • | X | • | - | - | - |
| Saxo (2003)   | X | • | X | • | - | - | - |
| Xsara (2000 - 2006)   | X | X | X | X | - | - | - |

① ② ③ ④ ⑤ ⑥ ⑦



## Dacia

|                   |   |   |   |   |   |   |   |
|-------------------|---|---|---|---|---|---|---|
| Dokker (2012)     | X | • | • | • | - | - | - |
| Duster (2012>)    | X | • | X | • | - | - | - |
| Duster (2018>)    | X | • | X | • | - | - | - |
| Lodgy (2012)      | X | • | • | • | - | - | - |
| Logan MCV (2013>) | X | • | X | • | - | - | - |
| Logan MCV (2018>) | X | • | X | • | - | - | - |
| Sandero (2013>)   | X | • | X | • | - | - | - |
| Sandero (2018>)   | X | • | X | • | - | - | - |

## Daihatsu















|                |   |   |   |   |   |   |   |
|----------------|---|---|---|---|---|---|---|
| Cuore (2007)   | X | • | X | • | - | - | - |
| Materia (2006) | X | • | X | • | - | - | - |
| Sirion (2005)  | X | • | X | • | - | - | - |
| Terios (2005)  | X | • | X | • | - | - | - |
| Trevis (2005)  | X | • | X | • | - | - | - |

## Fiat





|  |   |   |   |   |   |   |   |
|--|---|---|---|---|---|---|---|
| 124 Spider (2016>)   | X | - | - | - | - | - | - |
| 500 (2008>)  | X | • | - | • | - | - | - |
| 500 C (2009>)  | X | • | - | • | - | - | - |
|  500L (2013>) | X | • | X | • | - | - | - |
|  500X (2015>) | X | • | X | • | - | - | - |
| Abarth 500 (2009>)   | X | • | - | - | - | - | - |
| Abarth Grande Punto (2008 - 2011)  | X | • | X | • | - | - | - |
| Abarth 595 (2018>)   | X | • | - | - | - | - | - |
| GBT Punto (2014>)  | X | • | X | • | - | - | - |
| Bravo (2007>)  | X | • | X | • | - | - | - |
| Croma (2008)   | X | • | X | • | - | - | - |
| Doblo (2007)   | X | • | X | • | - | - | - |
| Doblo (2010>)  | X | • | X | • | - | - | - |
| Grande Punto (2006>)   | X | • | X | • | - | - | - |
| Idea (2007)  | X | • | X | • | - | - | - |
| Linea (2007)   | X | • | X | • | - | - | - |
| Multipla (2007)  | X | • | X | • | - | - | - |
| Panda (2012>)  | X | • | X | • | - | - | - |
| Qubo (2008>)   | X | • | X | • | - | - | - |
| Scudo II (2007)  | X | • | X | • | - | • | • |





Ford

|  |   |   |   |   |   |   |   |
|--|---|---|---|---|---|---|---|
| Sedici (2006)  | X | • | X | • | - | - | - |
|  Stilo (2007)             | X | • | X | • | - | - | - |
| Tipo (2016>)   | X | • | X | • | - | - | - |
| Tipo (2018>)   | X | • | X | • | - | - | - |
| Ulysse (2003)  | X | • | • | • | • | X | • |
|  |   |   |   |   |   |   |   |
|  B-Max (2012>)            | X | • | X | • | - | - | - |
| C-Max (2003 - 2010)  | X | X | X | X | - | - | - |
| C-Max (2010 - 2012)  | X | • | X | • | - | - | - |
|  C-Max (2012>)            | X | • | X | • | - | - | - |
|  C-Max (2018>)            | X | • | X | • | - | - | - |
| Grand C-Max (2012)   | X | • | X | • | - | - | - |
|  Grand C-Max (2018>)      | X | • | X | • | - | - | - |
|  EcoSport (2015>)         | X | • | X | • | - | - | - |
|  EcoSport (2018>)         | X | • | X | • | - | - | - |
|  Edge (2016>)             | X | • | X | • | X | - | X |
| Edge Sport (2018>)   | X | • | X | • | - | - | - |
| Fiesta (2004 - 2008)   | X | X | X | X | - | - | - |
| Fiesta (2008>)   | X | • | X | • | - | - | - |
| Fiesta 3dr (2016>)   | X | • | X | • | - | - | - |
| Fiesta 3dr (2018>)   | X | • | X | • | - | - | - |
| Fiesta 5dr (2016>)   | X | • | X | • | - | - | - |
| Fiesta 5dr (2018>)   | X | • | X | • | - | - | - |
| Fiesta Active (2018>)  | X | • | X | • | - | - | - |
| Focus (1998 - 2005)  | X | X | X | X | - | - | - |
| Focus (2005 - 2009)  | X | X | X | X | - | - | - |
|  Focus (2010 - 2015)      | X | • | X | • | - | - | - |
| Focus (2015>)  | X | • | X | • | - | - | - |
| Focus Estate (2017>)   | X | • | X | • | - | - | - |
| Focus ST Estate (2017>)  | X | • | X | • | - | - | - |
|  Focus EV (2015>)         | X | • | X | • | - | - | - |
|  Focus (2018>)            | X | • | X | • | - | - | - |
|  SBI Galaxy (2006 - 2015) | X | ! | X | ! | X | - | X |
| Galaxy (2016>)   | X | • | X | • | X | - | X |
|  SBI Galaxy (2017>)       | X | ! | • | ! | X | - | X |
| Ka (2009 - 2016)   | X | • | • | • | - | - | - |
|  Ka+ (2016>)             | X | • | X | • | - | - | - |
|  Ka+ (2018>)             | X | • | X | • | - | - | - |

Honda

|  |   |   |   |   |   |   |   |
|--|---|---|---|---|---|---|---|
| Kuga (2013>)   | X | • | X | • | - | - | - |
| Kuga (2018>)   | X | • | X | • | - | - | - |
| Maverick (2007)  | X | • | X | • | - | - | - |
| Mondeo (2002 - 2007)   | X | X | X | X | - | - | - |
| Mondeo Estate (2007 - 2015)  | X | • | X | • | - | - | - |
| Mondeo Estate (2017)   | X | • | X | • | - | - | - |
| Mondeo Hatchback (2007 - 2015)   | X | • | X | • | - | - | - |
| Mondeo Saloon (2007 - 2015)  | X | • | X | • | - | - | - |
|  Mondeo (2015>)     | X | • | X | • | - | - | - |
|  Mondeo (2007-2010) | X | • | X | • | - | - | - |
| Mondeo Turnier (2010)  | X | • | X | • | - | - | - |
| Mondeo Vignale (2018>)   | X | • | X | • | - | - | - |
| Mondeo Ranger (2011)   | X | • | X | • | - | - | - |
| SBI S-Max (2006 - 2015)  | X | ! | X | ! | X | - | X |
|  SBI S-Max (2014>)  | X | ! | X | ! | - | - | - |
|  S-Max (2016>)      | X | • | X | • | X | - | X |
| SBI S-Max (2018>)  | X | • | • | ! | X | - | X |
| Tourneo Connect (2013)   | X | • | X | • | - | - | - |
| Tourneo Custom (2012)  | X | • | X | • | X | - | • |
| Transit Connect (2006)   | X | • | • | X | - | - | - |
| Transit Kombi (2011)   | X | • | • | X | - | - | - |
| Transit Custom (2012)  | X | • | • | X | - | • | - |
| Vignale (2018>)  | X | • | X | • | - | - | - |
|  |   |   |   |   |   |   |   |
| Accord Saloon (2008>)  | X | • | X | • | - | - | - |
| Accord Tourer (2008>)  | X | • | X | • | - | - | - |
| City (2009)  | X | • | X | • | - | - | - |
| Civic (2006 - 2011)  | X | • | X | • | - | - | - |
| Civic (2012>)  | X | • | X | • | - | - | - |
| Civic (2018>)  | X | • | X | • | - | - | - |
| Civic Hybrid Saloon (2006 - 2010)  | X | • | X | • | - | - | - |
| Civic Type R (2007 - 2010)   | X | • | X | • | - | - | - |
| Civic Prestige (2006 - 2010)   | X | • | X | • | - | - | - |
| Civic Tourer (2014>)   | X | • | X | • | - | - | - |
| CR-V (2007 - 2013)   | X | • | X | • | - | - | - |
| CR-V (2012>)   | X | • | X | • | - | - | - |

|  |   |   |   |   |   |   |   |
|--|---|---|---|---|---|---|---|
| CR-V S Plus (2018>)  | X | • | X | • | - | - | - |
| CR-Z (2010>)   | X | • | X | • | - | - | - |
| ElySION (2012>)  | X | • | - | • | X | - | X |
| FRV (2005 - 2011)  | X | • | X | • | - | - | - |
|  HR-V (2015>) | X | • | X | • | - | - | - |
| HR-V (2018>)   | X | • | X | • | - | - | - |
| Insight (2009>)  | X | X | X | X | - | - | - |
| Jazz (2001 - 2008)   | X | X | X | X | - | - | - |
| Jazz (2008 - 2015)   | X | • | X | • | - | - | - |
|  Jazz (2016>) | X | • | X | • | - | - | - |
| Jazz (2018>)   | X | • | X | • | - | - | - |
| Jazz Sport (2018>)   | X | • | X | • | - | - | - |
| Legend (2006 - 2010)   | X | • | X | • | - | - | - |
| Odyssey (2010>)  | X | • | - | • | - | - | - |

## Hyundai

|   |   |   |   |   |   |   |   |
|---|---|---|---|---|---|---|---|
| Accent (2002)   | X | • | X | • | - | - | - |
| Coupe (2001)  | X | • | X | • | - | - | - |
| Elantra (2002)  | X | • | X | • | - | - | - |
| Excel (2002)  | X | • | X | • | - | - | - |
| Getz (2002 - 2005)  | X | • | X | • | - | - | - |
| Getz (2005 - 2011)  | X | • | X | • | - | - | - |
| Grandeur (2005)   | X | • | X | • | - | - | - |
| i10 (2008>)   | X | • | X | • | - | - | - |
| i10 Hatch (2018>)   | X | • | X | • | - | - | - |
| i20 (2015>)   | X | • | X | • | - | - | - |
| i20 Hatch (2009>)   | X | • | X | • | - | - | - |
| i30 (2012 - 2015)   | X | • | X | • | - | - | - |
| i30 (2015>)   | X | • | X | • | - | - | - |
| i30 (2018>)   | X | • | X | • | - | - | - |
| i40 (2011>)   | X | • | X | • | - | - | - |
| i40 (2018>)   | X | • | X | • | - | - | - |
|  i800/H1 (2008>) | X | • | X | • | X | X | X |
| Ioniq (2016>)   | X | • | X | • | - | - | - |
| iX20 (2010>)  | X | • | X | • | - | - | - |
| iX35 (2010>)  | X | • | X | • | - | - | - |
| iX55 (2009>)  | X | • | X | • | - | - | - |
| Kona (2018>)  | X | • | X | • | - | - | - |

|  |   |   |   |   |   |   |   |
|--|---|---|---|---|---|---|---|
| Matrix (2008)  | X | • | X | • | - | - | - |
| Pony (2002)  | X | • | X | • | - | - | - |
| Santa Fe (2002)  | X | • | X | • | - | - | - |
| Santa Fe (2007 - 2012)   | X | • | X | • | X | - | X |
| Santa Fe (2012>)   | X | • | X | • | - | - | - |
| Santa Fe (2018>)   | X | • | X | • | - | - | - |
| Tucson (2004>)   | X | • | X | • | - | - | - |
| Tucson (2010>)   | X | • | X | • | - | - | - |
|  Tucson (2015>) | X | • | X | • | - | - | - |
| Tucson (2018>)   | X | • | X | • | - | - | - |
| Veloster (2012>)   | X | • | - | • | - | - | - |
| Verna (2002)   | X | • | X | • | - | - | - |



## Infiniti

|                  |   |   |   |   |   |   |   |
|------------------|---|---|---|---|---|---|---|
| EX SUV (2009>)   | X | • | X | • | - | - | - |
| FX SUV (2009>)   | X | • | X | • | - | - | - |
| G70 (2016)       | X | • | X | • | - | - | - |
| G Coupe (2009>)  | X | • | - | • | - | - | - |
| G Saloon (2009>) | X | • | X | • | - | - | - |
| M Saloon (2010>) | X | • | X | • | - | - | - |

## Isuzu

|              |   |   |   |   |   |   |   |
|--------------|---|---|---|---|---|---|---|
| D-Max (2007) | X | • | X | • | - | - | - |
|--------------|---|---|---|---|---|---|---|

## Jaguar

|  |   |   |   |   |   |   |   |
|--|---|---|---|---|---|---|---|
|  E-Pace (2018>) | X | • | X | • | - | - | - |
| F-Pace (2016>)   | X | • | X | • | - | - | - |
| S-Type (2002)  | X | • | X | • | - | - | - |
| F-Type Coupe (2014>)   | X | - | - | - | - | - | - |
| X-Type (2001 - 2010)   | X | • | X | • | - | - | - |
| X-Type Estate (2004 - 2010)  | X | • | X | • | - | - | - |
|  XE (2015>)     | X | • | X | • | - | - | - |
| XE (2018>)   | X | • | X | • | - | - | - |
| XF (2008>)   | X | • | X | • | - | - | - |
| XF (2009>)   | X | • | X | • | - | - | - |
| XF (2015>)   | X | • | X | • | - | - | - |

① ② ③ ④ ⑤ ⑥ ⑦

|   |                        |   |   |   |   |   |   |   |
|---|------------------------|---|---|---|---|---|---|---|
|  | XF (2018>)             | X | • | X | • | - | - | - |
|   | XF R (2009>)           | X | • | X | • | - | - | - |
|   | XF Sportbrake (2013>)  | X | • | X | • | - | - | - |
|   | XF Sportbrake (2018>)  | X | • | X | • | - | - | - |
|   | XJ (2003)              | X | • | X | • | - | - | - |
|   | XJ (2010>)             | X | • | X | • | - | - | - |
|   | XJ (2018>)             | X | • | X | • | - | - | - |
|   | XK Coupe (2006>)       | X | • | - | • | - | - | - |
|   | XK Convertible (2006>) | X | • | - | • | - | - | - |
|   | XK R (2006>)           | X | • | - | • | - | - | - |

Jeep

|  |                        |   |   |   |   |   |   |   |
|--|------------------------|---|---|---|---|---|---|---|
|  | Cherokee (2014>)       | X | • | X | • | - | - | - |
|  | Compass (2011>)        | X | • | X | • | - | - | - |
|  | Commander (2006)       | X | • | X | • | - | - | - |
|  | Grand Cherokee (2010>) | X | • | X | • | - | - | - |
|  | Grand Patriot (2007)   | X | • | X | • | - | - | - |
|  | Renegade (2015>)       | X | • | X | • | - | - | - |
|  | Wrangler 5dr (2007>)   | X | X | X | X | - | - | - |
|  | Wrangler (2011)        | X | • | X | • | - | - | - |

Kia

|   |                      |   |   |   |   |   |   |   |
|---|----------------------|---|---|---|---|---|---|---|
|   | Carens (2006)        | X | • | X | • | - | - | - |
| SBI   | Carens (2013>)       | X | ! | X | ! | X | - | X |
|   | Carens (2018>)       | X | • | X | • | X | - | X |
|   | Carnival (2006)      | X | • | X | • | • | • | • |
|   | Cee'D (2006)         | X | • | X | • | - | - | - |
|   | Cee'D Hatch (2012>)  | X | • | X | • | - | - | - |
|   | Cee'D Hatch (2018>)  | X | • | X | • | - | - | - |
|   | Magentis (2002-2005) | X | • | X | • | - | - | - |
|   | Mentor (2002)        | X | • | X | • | - | - | - |
|   | Niro (2018>)         | X | • | X | • | - | - | - |
|   | Opirus (2003)        | X | • | X | • | - | - | - |
|  | Optima (2011 - 2015) | X | • | X | • | - | - | - |
|   | Optima (2016>)       | X | • | X | • | - | - | - |
|   | Picanto (2008>)      | X | • | X | • | - | - | - |
|   | Picanto (2011>)      | X | • | X | • | - | - | - |

① ② ③ ④ ⑤ ⑥ ⑦

|   |                        |   |   |   |   |   |   |   |
|---|------------------------|---|---|---|---|---|---|---|
|   | Picanto (2018>)        | X | • | X | • | - | - | - |
|   | Rio (2012>)            | X | • | X | • | - | - | - |
|   | Rio (2018>)            | X | • | X | • | - | - | - |
|   | Sephia (2002)          | X | • | X | • | - | - | - |
|   | Shuma (2002)           | X | • | X | • | - | - | - |
|   | Sorento (2010 - 2014)  | X | • | X | • | - | - | - |
|   | Sorento (2015>)        | X | • | X | • | X | - | X |
|   | Soul (2009>)           | X | • | X | • | - | - | - |
| ⚡   | Soul EV (2015>)        | X | • | X | • | - | - | - |
|   | Soul (2018>)           | X | • | X | • | - | - | - |
|   | Spectra (2002)         | X | • | X | • | - | - | - |
|   | Sportage (2011 - 2015) | X | • | X | • | - | - | - |
|  | Sportage (2016>)       | X | • | X | • | - | - | - |
|   | Sportage (2018>)       | X | • | X | • | - | - | - |
|   | Stonic (2018>)         | X | • | X | • | - | - | - |
|   | Venga (2009>)          | X | • | X | • | - | - | - |

Lancia



|  |                 |   |   |   |   |   |   |   |
|--|-----------------|---|---|---|---|---|---|---|
|  | Delta (2008>)   | X | • | X | • | - | - | - |
|  | Flavia (2012)   | X | • | X | • | - | - | - |
|  | Musa (2004)     | X | • | X | • | - | - | - |
|  | Phedra (2002)   | X | • | X | • | - | - | - |
|  | Thema (2011>)   | X | • | X | • | - | - | - |
|  | Voyager (2010>) | X | • | - | • | X | X | X |
|  | Ypsilon (2003)  | X | • | X | • | - | - | - |
|  | Ypsilon (2012>) | X | • | X | • | - | - | - |

Land Rover

|  |                                |   |   |   |   |   |   |   |
|--|--------------------------------|---|---|---|---|---|---|---|
|  | Discovery 4 (2009>)            | X | • | X | • | - | - | - |
|  | Discovery 5 (2016)             | X | • | X | • | - | - | - |
|  | Discovery Sport (2015>)        | X | • | X | • | X | - | X |
|  | Discovery Sport (2018>)        | X | • | X | • | X | - | X |
|  | All New Discovery 5 (2018>)    | X | • | X | • | X | - | X |
|  | Freelander 2 (2006>)           | X | • | X | • | - | - | - |
|  | Range Rover (2002 - 2012)      | X | • | X | • | - | - | - |
|  | Range Rover (2013>)            | X | • | X | • | - | - | - |
|  | Range Rover Evoque 3dr (2011>) | X | • | X | • | - | - | - |

|                                 |   |   |   |   |   |   |   |
|---------------------------------|---|---|---|---|---|---|---|
| Range Rover Evoque 5dr (2011>)  | X | • | X | • | - | - | - |
| Range Rover Evoque 3dr (2018>)  | X | • | X | • | - | - | - |
| Range Rover Evoque 5dr (2018>)  | X | • | X | • | - | - | - |
| Range Rover Sport (2005 - 2012) | X | • | X | • | - | - | - |
| Range Rover Sport (2013>)       | X | • | X | • | - | - | - |
| ⚡ Range Rover Sport (2018>)     | X | • | X | • | - | - | - |
| Range Rover Velar (2017)        | X | • | X | • | - | - | - |
| Range Rover Velar (2018>)       | X | • | X | • | - | - | - |
| Range Rover Vogue (2018>)       | X | • | X | • | - | - | - |

**Lexus**

|  |   |   |   |   |   |   |   |
|--|---|---|---|---|---|---|---|
| CT (2011>)   | X | • | X | • | - | - | - |
| CT (2018>)   | X | • | X | • | - | - | - |
| GS (2000-2013)   | X | • | X | • | - | - | - |
| GS (2013>)   | X | • | X | • | - | - | - |
| ⚡ GSh (2013>)  | X | • | X | • | - | - | - |
| IS Saloon (2005 - 2012)  | X | • | X | • | - | - | - |
| IS Saloon (2018>)  | X | • | X | • | - | - | - |
| LS430 (2000)   | X | • | X | • | - | - | - |
| LS 500h (2018>)  | X | • | X | • | - | - | - |
|  NX (2014>)       | X | • | X | • | - | - | - |
|  NX Sport (2018>) | X | • | X | • | - | - | - |
| RC 3dr (2018>)   | X | • | X | • | - | - | - |
| RX300/RX400 (2006)   | X | • | X | • | - | - | - |
| ⚡ RX450h (2009)  | X | • | X | • | - | - | - |
| RX (2010>)   | X | • | X | • | - | - | - |
| RX (2018>)   | X | • | X | • | - | - | - |
| RXL (2018>)  | X | • | X | • | - | - | - |



**Maserati**

|                     |   |   |   |   |   |   |   |
|---------------------|---|---|---|---|---|---|---|
| Quattroporte (2008) | X | • | X | • | - | - | - |
| Gran Turismo (2008) | X | • | X | • | - | - | - |

**Maybach**

|                  |   |   |   |   |   |   |   |
|------------------|---|---|---|---|---|---|---|
| W240/V240 (2002) | X | • | X | • | - | - | - |
|------------------|---|---|---|---|---|---|---|

**Mazda**

|  |   |   |   |   |   |   |   |
|--|---|---|---|---|---|---|---|
|  2 (2015>)        | X | • | X | • | - | - | - |
|  2 (2007 - 2015)  | X | • | X | • | - | - | - |
| 3 Hatchback (2014>)  | X | • | X | • | - | - | - |
| 3 Hatchback (2009 - 2013)  | X | • | X | • | - | - | - |
| 3 Saloon (2009 - 2013)   | X | • | X | • | - | - | - |
| 323 (2001)   | X | • | X | • | - | - | - |
| 5 (2005 - 2010)  | X | • | X | • | - | - | - |
| 6 Estate (2012>)   | X | • | X | • | - | - | - |
| 6 Hatch (2007 - 2012)  | X | • | X | • | - | - | - |
| 6 Saloon (2007 - 2009)   | X | • | X | • | - | - | - |
| 6 Saloon (2012>)   | X | • | X | • | - | - | - |
| 6 Saloon (2018>)   | X | • | X | • | - | - | - |
| 6 (2002-2008)  | X | • | X | • | - | - | - |
| 6 Estate (2008 - 2012)   | X | • | X | • | - | - | - |
| 6 Estate (2012>)   | X | • | X | • | - | - | - |
|  6 Estate (2018>) | X | • | X | • | - | - | - |
| CX-3 (2015>)   | X | • | X | • | - | - | - |
| CX-5 (2011>)   | X | • | X | • | - | - | - |
| CX-5 (2018>)   | X | • | X | • | - | - | - |
| CX-7 (2007 - 2011)   | X | • | X | • | - | - | - |
| Demio (2007)   | X | • | X | • | - | - | - |
| MPV (2002)   | X | • | X | • | - | - | - |
| Premacy (2001)   | X | • | X | • | - | - | - |
| MX-5 (1998-2005)   | X | • | - | - | - | - | - |
| MX-5 (2015>)   | X | • | - | - | - | - | - |
| RX-8 (2003)  | X | • | X | • | - | - | - |
| Tribute (2001)   | X | • | X | • | - | - | - |
| Verisa (2004)  | X | • | X | • | - | - | - |

**Mercedes-Benz**

|                       |   |   |   |   |   |   |   |
|-----------------------|---|---|---|---|---|---|---|
| A Class (2001 - 2005) | X | • | X | • | - | - | - |
| A Class (2005 - 2012) | X | • | X | • | - | - | - |
| A-Class (2013>)       | X | • | X | • | - | - | - |
| ⚡ B-Class (2011>)     | X | • | X | • | - | - | - |
| B-Class EV (2015>)    | X | • | X | • | - | - | - |
| C-Class (2000)        | X | • | X | • | - | - | - |
| C-Class (2008>)       | X | • | X | • | - | - | - |
| C-Class Coupe (2011>) | X | • | - | - | - | - | - |

|                              |   |   |   |   |   |   |   |
|------------------------------|---|---|---|---|---|---|---|
| C-Class Estate (2008>)       | X | . | X | . | - | - | - |
| C-Class Estate (2015>)       | X | . | X | . | - | - | - |
| Citan (2012)                 | X | . | X | . | - | - | - |
| CLA (2013>)                  | X | . | X | . | - | - | - |
| CLC (2008)                   | X | . | X | . | - | - | - |
| CLK (2002-2010)              | X | . | X | . | - | - | - |
| CLS Coupe (2004)             | X | . | X | . | - | - | - |
| CLS Coupe (2011>)            | X | . | X | . | - | - | - |
| CLS Coupe (2018>)            | X | . | X | . | - | - | - |
| CLS Shooting Brake (2012>)   | X | . | X | . | - | - | - |
| E-Class Coupe (2009>)        | X | . | . | . | - | - | - |
| E-Class (2002)               | X | . | X | . | - | - | - |
| E-Class (2006 - 2009)        | X | . | X | . | - | - | - |
| E-Class (2018>)              | X | . | X | . | - | - | - |
| E-Class Saloon (2009 - 2012) | X | . | X | . | - | - | - |
| E-Class Saloon (2013>)       | X | . | X | . | - | - | - |
| E-Class Estate (2009>)       | X | . | X | . | - | - | - |
| E-Class Estate (2013>)       | X | . | X | . | - | - | - |
| GL Class (2006 - 2012)       | X | . | X | . | - | - | - |
| GL Class (2012>)             | X | . | X | . | X | - | X |
| GLA (2014>)                  | X | . | X | . | - | - | - |
| GLA (2018>)                  | X | . | X | . | - | - | - |
| GLC SUV (2018>)              | X | . | X | . | - | - | - |
| GLE (2015>)                  | X | . | X | . | - | - | - |
| GLE SUV (2018>)              | X | . | X | . | - | - | - |
| GLK (2012)                   | X | . | X | . | - | - | - |
| GLS (2018>)                  | X | . | X | . | . | . | . |
| M (2011)                     | X | . | X | . | - | - | - |
| ML-Class (2005 - 2012)       | X | . | X | . | - | - | - |
| ML-Class (2012>)             | X | . | X | . | - | - | - |
| M-Klasse (1997-2005)         | X | . | X | . | - | - | - |
| R-Class (2005 - 2012)        | X | . | X | . | - | - | - |
| S Class (2015>)              | X | . | X | . | - | - | - |
| S Class (2006 - 2013)        | X | . | X | . | - | - | - |
| SL Class (2011>)             | X | - | - | - | - | - | - |
| SLK (2011>)                  | X | - | - | - | - | - | - |
| S-Class (2005 - 2015)        | X | . | X | . | - | - | - |
| Sprinter (2006)              | X | . | X | . | - | - | - |
| V-Class (2014>)              | X | . | . | . | . | X | . |

**MG**



|                          |   |   |   |   |   |   |   |
|--------------------------|---|---|---|---|---|---|---|
| V-Class (2018>)          | X | . | . | . | X | . | . |
| Vaneo (2001-2005)        | X | . | . | . | - | - | - |
| Viano (2003-2010)        | X | . | X | . | . | . | . |
| Vito (2010)              | X | . | . | X | . | . | - |
| 25 (1999 - 2005)         | X | X | X | X | - | - | - |
| GS (2016>)               | X | . | X | . | - | - | - |
| 3 (2013 - 2015)          | X | . | X | . | - | - | - |
| 3 (2016>)                | X | . | X | . | - | - | - |
| Streetwise (1999 - 2005) | X | X | X | X | - | - | - |
| ZR (2001 - 2005)         | X | X | X | X | - | - | - |
| ZT (2003 - 2006)         | X | X | X | X | - | - | - |

**MINI**

|                         |   |   |   |   |   |   |   |
|-------------------------|---|---|---|---|---|---|---|
| Countryman (2010>)      | X | . | X | . | - | - | - |
| Countryman 4 (2010>)    | X | . | X | . | - | - | - |
| Countryman 5 (2010>)    | X | . | X | . | - | - | - |
| R56 (2010>)             | X | . | X | . | - | - | - |
| R57 (2009>)             | X | . | X | . | - | - | - |
| Hatchback (2006 - 2014) | X | . | - | . | - | - | - |
| Hatchback (2014>)       | X | . | - | . | - | - | - |
| Cooper S (2006>)        | X | . | X | . | - | - | - |
| Coupe (2009>)           | X | - | - | - | - | - | - |
| Coupe (2014>)           | X | X | X | X | - | - | - |
| Hatchback 3Dr (2014>)   | X | . | - | . | - | - | - |
| Hatchback 5dr (2015>)   | X | . | X | . | - | - | - |
| Paceman (2013>)         | X | . | - | . | - | - | - |
| 5dr (2015>)             | X | . | X | . | - | - | - |

**Mitsubishi**

|                      |   |   |   |   |   |   |   |
|----------------------|---|---|---|---|---|---|---|
| ASX (2010>)          | X | . | X | . | - | - | - |
| Colt (2004 - 2008)   | X | . | X | . | - | - | - |
| Colt (2007 - 2013)   | X | . | X | . | - | - | - |
| Grandis (2004-2011)  | X | . | X | . | - | - | - |
| Lancer (2007 - 2011) | X | . | - | . | - | - | - |

|  |   |   |   |   |   |   |   |
|--|---|---|---|---|---|---|---|
| Lancer Evo (2004)  | X | • | - | • | - | - | - |
| Lancer Ralliart (2009 - 2011)  | X | • | - | • | - | - | - |
| Lancer Sportback (2008 - 2012)   | X | • | - | • | - | - | - |
| Mirage (2014>)   | X | • | X | • | - | - | - |
| Mirage 5dr (2016)  | X | • | X | • | - | - | - |
| Outlander (2003)   | X | • | X | • | - | - | - |
| Outlander (2006 - 2013)  | X | • | X | • | - | - | - |
| Outlander (2013>)  | X | • | X | • | - | - | - |
|  Outlander PHEV (2015>) | X | • | X | • | - | - | - |
| Pajero (2007)  | X | • | X | • | - | - | - |
| Shogun (2007>)   | X | • | X | • | - | - | - |

Nissan

|   |   |   |   |   |   |   |   |
|---|---|---|---|---|---|---|---|
| Almera (2000)   | X | • | X | • | - | - | - |
| Juke (2010>)  | X | • | X | • | - | - | - |
| Juke (2018>)  | X | • | X | • | - | - | - |
| Leaf EV (2011>)   | X | • | X | • | - | - | - |
|  New Leaf EV (2018>) | X | • | X | • | - | - | - |
| Maxima (1999)   | X | • | X | • | - | - | - |
| Micra (2000)  | X | • | X | • | - | - | - |
| Micra (2011>)   | X | • | X | • | - | - | - |
| Micra (2018>)   | X | • | X | • | - | - | - |
| Murano (2003)   | X | • | X | • | - | - | - |
| Murano (2016>)  | X | • | X | • | - | - | - |
| Navara (2005)   | X | • | X | • | - | - | - |
| Note (2004 - 2013)  | X | • | X | • | - | - | - |
| Note (2014>)  | X | • | X | • | - | - | - |
| Pathfinder (2007)   | X | • | X | • | - | - | - |
| Pixo (2009)   | X | • | X | • | - | - | - |
| Primera (1996-2002)   | X | • | X | • | - | - | - |
| Pulsar (2015>)  | X | • | X | • | - | - | - |
| Qashqai +2 (2008 - 2015)  | X | • | X | • | - | - | - |
| Qashqai (2007 - 2013)   | X | • | X | • | - | - | - |
| Qashqai (2014>)   | X | • | X | • | - | - | - |
| Qashqai (2018>)   | X | • | X | • | - | - | - |
| Quest MPV (2012>)   | X | • | - | - | X | - | X |
| Tiida (2004)  | X | • | X | • | - | - | - |
| 2008 X-Trail (2001)   | X | • | X | • | - | - | - |

|                            |   |   |   |   |   |   |   |
|----------------------------|---|---|---|---|---|---|---|
| 2008 X-Trail (2007 - 2015) | X | • | X | • | - | - | - |
| X-Trail (2015>)            | X | • | X | • | X | - | X |
| X-Trail (2018>)            | X | • | X | • | X | - | X |

Opel

|  |   |   |   |   |   |   |   |
|--|---|---|---|---|---|---|---|
| Adam (2013>)   | X | • | - | • | - | - | - |
| Agila (2002)   | X | • | X | • | - | - | - |
| Agila (2008>)  | X | • | X | • | - | - | - |
|  Ampera (2011>) | X | • | - | • | - | - | - |
| Antara (2006 - 2015)   | X | • | X | • | - | - | - |
| Astra (2004 - 2010)  | X | • | X | • | - | - | - |
| Astra 5dr (2010>)  | X | • | X | • | - | - | - |
| Astra (2015>)  | X | • | X | • | - | - | - |
| Astra Estate (2010>)   | X | • | X | • | - | - | - |
| Astra GTC (2011>)  | X | • | X | • | - | - | - |
| Caravan (2004)   | X | • | X | • | - | - | - |
| Combo (2001)   | X | • | X | • | - | - | - |
| Corsa 3 dr Hatch (2006 - 2015)   | X | • | X | • | - | - | - |
| Corsa 5 dr Hatch (2006 - 2015)   | X | • | X | • | - | - | - |
| Corsa 5dr (2015>)  | X | • | X | • | - | - | - |
|  Corsa C (2000) | X | • | X | • | - | - | - |
| Corsa D (2006>)  | X | • | X | • | - | - | - |
| Corsa VXR (2007>)  | X | • | X | • | - | - | - |
| Insignia Hatch (2008>)   | X | • | X | • | - | - | - |
| Insignia Saloon (2009>)  | X | • | X | • | - | - | - |
| Insignia Sports Tourer (2009>)   | X | • | X | • | - | - | - |
| Karl (2015>)   | X | • | X | • | - | - | - |
| Meriva (2002)  | X | • | X | • | - | - | - |
| Meriva (2010>)   | X | • | X | • | - | - | - |
| Mokka (2012>)  | X | • | X | • | - | - | - |
| Signum (2003-2008)   | X | • | X | • | - | - | - |
| Vectra (2002 - 2008)   | X | • | X | • | - | - | - |
| Vivaro (2001)  | X | • | X | • | - | - | - |
| Zafira (2005 - 2014)   | X | • | X | • | - | - | - |
| Zafira Tourer (2012>)  | X | • | X | • | X | - | X |
| Zafira VXR (2005>)   | X | • | X | • | - | - | - |

Peugeot





|  |   |   |   |   |   |   |   |
|--|---|---|---|---|---|---|---|
| 107 (2005 - 2014)  | X | • | - | • | - | - | - |
| 108 (2014)   | X | • | X | • | - | - | - |
| 108 (2015>)  | X | • | - | - | - | - | - |
| 108 (2018>)  | X | • | - | • | - | - | - |
| 206 (1998)   | X | • | X | • | - | - | - |
| 206 3dr (2004 - 2009)  | X | • | X | • | - | - | - |
| 207 3dr (2006 - 2012)  | X | • | X | • | - | - | - |
| 207 5dr (2006 - 2012)  | X | • | X | • | - | - | - |
| 207 SW (2007 - 2012)   | X | • | X | • | - | - | - |
| 208 3dr (2012>)  | X | • | X | • | - | - | - |
| 208 5dr (2012>)  | X | • | X | • | - | - | - |
| 208 3dr (2018>)  | X | • | X | • | - | - | - |
| 208 5dr (2018>)  | X | • | X | • | - | - | - |
| 307 (2001 - 2008)  | X | • | X | • | - | - | - |
| 307 Estate (2002 - 2007)   | X | • | X | • | - | - | - |
| 308 (2018>)  | X | • | X | • | - | - | - |
| 308 (2014>)  | X | • | X | • | - | - | - |
| 308 Hatch (2007 - 2014)  | X | • | X | • | - | - | - |
| 308 SW (2008 - 2015)   | X | • | X | • | - | - | - |
| 308 SW (2014>)   | X | • | X | • | - | - | - |
|  406 (2000) | X | • | X | • | - | - | - |
| 407 (2004 - 2011)  | X | • | X | • | - | - | - |
| 407 SW (2004 - 2011)   | X | • | X | X | X | - | - |
| 508 (2011>)  | X | • | X | • | - | - | - |
| 607 (2000)   | X | • | X | • | - | - | - |
| SBI! 807 (2002-2010)   | X | ! | X | ! | • | - | • |
| 1007 (2005)  | X | • | X | • | - | - | - |
| 2008 (2013>)   | X | • | X | • | - | - | - |
| 2008 (2018>)   | X | • | X | • | - | - | - |
| SBI! 3008 (2009 - 2016)  | X | ! | X | ! | • | - | - |
| 3008 (2017>)   | X | • | X | • | - | - | - |
| 3008 (2018>)   | X | • | X | • | - | - | - |
| 4007 (2007 - 2012)   | X | • | X | • | - | - | - |
| 4008 (2011>)   | X | • | X | • | - | - | - |
| 5008 (2009>)   | X | • | • | • | X | - | X |
| SBI! 5008 (2010>)  | X | ! | X | ! | X | X | X |
| 207 SW (2007 - 2012)   | X | • | X | • | - | - | - |
| 208 5DR (2013>)  | X | • | X | • | - | - | - |
| 308 SW (2008 - 2015)   | X | • | X | • | - | - | - |

|                             |   |   |   |   |   |   |   |
|-----------------------------|---|---|---|---|---|---|---|
| 308 SW (2015>)              | X | • | X | • | - | - | - |
| 508 RXH (2013>)             | X | • | X | • | - | - | - |
| 508 SW (2011>)              | X | • | X | • | - | - | - |
| Bipper (2008>)              | X | • | X | • | - | - | - |
| Expert Tepee (2007 - 2016)  | X | • | X | • | X | X | X |
| Partner Combi (2004 - 2010) | X | • | X | • | X | - | - |
| Partner Tepee (2008>)       | X | • | X | • | - | - | - |
| RCZ (2011)                  | X | • | - | X | - | - | - |
| Traveller (2016>)           | X | • | • | • | • | • | • |
| Traveller (2018>)           | X | • | • | • | • | • | • |

Pontiac

|                  |   |   |   |   |   |   |   |
|------------------|---|---|---|---|---|---|---|
| Pontiac Grand AM | X | • | X | • | - | - | - |
|------------------|---|---|---|---|---|---|---|

Porsche

|  |   |   |   |   |   |   |   |
|--|---|---|---|---|---|---|---|
| Cayenne (2003)   | X | • | X | • | - | - | - |
| Cayenne (2011>)  | X | • | X | • | - | - | - |
|  Cayenne E-Hybrid (2015>)  | X | • | X | • | - | - | - |
|  Cayenne E-Hybrid (2018>)  | X | • | X | • | - | - | - |
| Macan (2014)   | X | • | X | • | - | - | - |
| Macan Turbo (2018>)  | X | • | X | • | - | - | - |
| Panamera (2009>)   | X | • | - | • | - | - | - |
| Panamera (2011>)   | X | • | - | • | - | - | - |
|  Panamera E-Hybrid (2015>) | X | • | - | • | - | - | - |
|  Panamera E-Hybrid (2018>) | X | • | - | • | - | - | - |
| Panamera Estate (2018>)  | X | • | X | • | - | - | - |

Renault

|                                 |   |   |   |   |   |   |   |
|---------------------------------|---|---|---|---|---|---|---|
| Avantime (2001)                 | X | • | X | • | - | - | - |
| Captur (2013>)                  | X | • | X | • | - | - | - |
| Captur (2018>)                  | X | • | X | • | - | - | - |
| Clio Sport (2006 - 2012)        | X | • | X | • | - | - | - |
| Clio Sport (2013>)              | X | • | X | X | - | - | - |
| Clio Sport 5dr (2017>)          | X | • | X | • | - | - | - |
| Clio Sport Tourer (2007 - 2012) | X | • | X | • | - | - | - |
| Clio Sport Tourer (2013>)       | X | • | X | • | - | - | - |

|   |   |   |   |   |   |   |   |
|---|---|---|---|---|---|---|---|
| Clio (1998 - 2003)  | X | • | X | • | - | - | - |
| Clio (2005 - 2012)  | X | • | X | • | - | - | - |
| Clio (2013>)  | X | • | X | • | - | - | - |
| Clio (2018>)  | X | • | X | • | - | - | - |
| Espace (2003 - 2012)  | X | • | • | • | • | • | • |
| Fluence (2010)  | X | • | X | • | - | - | - |
| Grand Espace (2000)   | X | • | • | • | • | • | • |
| Grand Espace (2002 - 2012)  | X | • | • | • | • | • | • |
| Grand Modus (2008 - 2012)   | X | • | X | • | - | - | - |
| Grand Scenic (2009)   | X | X | • | X | - | - | - |
| Kangoo (1999)   | X | X | X | • | - | - | - |
| Kangoo (2008-2013)  | X | • | X | • | - | - | - |
| Kadjar (2015>)  | X | • | X | • | - | - | - |
| Kadjar (2018>)  | X | • | X | • | - | - | - |
| Koleos (2018>)  | X | • | X | • | - | - | - |
| Laguna (2001)   | X | • | X | • | - | - | - |
| Laguna (2008 - 2012)  | X | • | X | • | - | - | - |
| Laguna GrandTour (2010)   | X | • | X | • | - | - | - |
| Laguna Sport Tourer (2008 - 2012)   | X | • | X | • | - | - | - |
| Megane (1999)   | X | • | X | • | - | - | - |
| Megane (2007)   | X | • | X | • | - | - | - |
| Megane Coupe (2003)   | X | • | X | • | - | - | - |
| Megane Grand Tour (1999-2003)   | X | • | X | • | - | - | - |
| Megane Grand Tour (2009)  | X | • | X | • | - | - | - |
| Megane Hatch (2002 - 2009)  | X | • | X | • | - | - | - |
| SB! Megane Hatch (2008>)  | X | ! | X | ! | - | - | - |
| Megane Hatch (2016>)  | X | • | X | • | - | - | - |
| Megane Scenic (2003)  | X | • | X | • | - | - | - |
| Megane Sport Tourer (2009>)   | X | • | X | • | - | - | - |
|  Megane Sport Tourer (2018>) | X | • | X | • | - | - | - |
| Modus (2004 - 2012)   | X | • | X | • | - | - | - |
| Grand Modus (2008 - 2012)   | X | • | X | • | - | - | - |
| Sandero (2012)  | X | • | X | • | - | - | - |
| Scenic/Grand Scenic (1999)  | X | • | X | • | - | - | - |
| Scenic (2002 - 2009)  | X | • | X | • | - | - | - |
| SB! Scenic (2009 - 2016)  | X | ! | X | ! | - | - | - |
| Scenic (2018>)  | X | • | X | • | - | - | - |
| Trafic (2001-2007)  | X | X | • | X | • | - | - |
| Trafic (2010)   | X | • | • | X | - | - | - |



|                      |   |   |   |   |   |   |   |
|----------------------|---|---|---|---|---|---|---|
| Twingo (1998 - 2007) | X | • | X | • | - | - | - |
| Twingo (2007 - 2014) | X | • | - | • | - | - | - |
| Twingo (2015>)       | X | • | - | • | - | - | - |
| Twingo (2018>)       | X | • | - | • | - | - | - |
| VeJ Satis (2002)     | X | • | X | • | - | - | - |
| ⚡ Zoe (2012)         | X | • | X | • | - | - | - |

SAAB

|                               |   |   |   |   |   |   |   |
|-------------------------------|---|---|---|---|---|---|---|
| 9-3 (2002 - 2012)             | X | • | X | • | - | - | - |
| 9-3 Sport Wagon (2005 - 2012) | X | • | X | • | - | - | - |
| 9-3 X (2009 - 2012)           | X | • | X | • | - | - | - |
| 9-5 (2011 - 2012)             | X | • | X | • | - | - | - |
| 9-5 Estate (2005 - 2010)      | X | • | X | • | - | - | - |

SEAT

|                                    |   |   |   |   |   |   |   |
|------------------------------------|---|---|---|---|---|---|---|
| Alhambra (1995 - 2010)             | X | • | • | • | • | - | - |
| SB! Alhambra (2010>)               | X | ! | X | ! | - | - | - |
| Altea (2004 - 2011)                | X | • | X | • | - | - | - |
| Altea Freetrack4 (2007 - 2009)     | X | • | X | • | - | - | - |
| Altea XL (2006 - 2011)             | X | • | X | • | - | - | - |
| Arona (2018>)                      | X | • | X | • | - | - | - |
| Arosa (1997 - 2004)                | X | • | X | • | - | - | - |
| Ateca Estate (2018>)               | X | • | X | • | - | - | - |
| Cordoba Vario (1996 - 2002)        | X | • | - | - | - | - | - |
| Exeo (2008 - 2014)                 | X | • | X | • | - | - | - |
| Exeo ST Estate (2008 - 2014)       | X | • | X | • | - | - | - |
| Ibiza (1993 - 2002)                | X | • | X | • | - | - | - |
| Ibiza (2002 - 2008)                | X | • | X | • | - | - | - |
| Ibiza Cupra (2009>)                | X | • | X | • | - | - | - |
| Ibiza FR (2009>)                   | X | • | X | • | - | - | - |
| Ibiza Hatch (2008 - 2013)          | X | • | X | • | - | - | - |
| Ibiza Hatch (2018>)                | X | • | X | • | - | - | - |
| Inca (2000)                        | X | • | X | • | - | - | - |
| Leon Cupra (2007 - 2011)           | X | • | X | • | - | - | - |
| Leon Cupra Special Edition (2018>) | X | • | X | • | - | - | - |
| Leon FR (2006 - 2012)              | X | • | X | • | - | - | - |
| Leon Hatch (2005 - 2015)           | X | • | X | • | - | - | - |



|                           |   |   |   |   |   |   |   |
|---------------------------|---|---|---|---|---|---|---|
| Leon (1998)               | X | • | X | • | - | - | - |
| Leon (2013>)              | X | • | X | • | - | - | - |
| Leon (2018>)              | X | • | X | • | - | - | - |
| Leon Sport Tourer (2018>) | X | • | X | • | - | - | - |
| Mii (2011>)               | X | • | X | • | - | - | - |
| Mii 3dr (2014>)           | X | • | X | • | - | - | - |
| Mii 5dr (2016>)           | X | • | X | • | - | - | - |
| Mii 3dr (2018>)           | X | • | X | • | - | - | - |
| Mii 5dr (2018>)           | X | • | X | • | - | - | - |
| Toledo (1994 - 2004)      | X | • | X | • | - | - | - |
| Toledo (2013>)            | X | • | X | • | - | - | - |
| Toledo (2018>)            | X | • | X | • | - | - | - |

Skoda

|  |   |   |   |   |   |   |   |
|--|---|---|---|---|---|---|---|
| Citigo (2011>)   | X | • | X | • | - | - | - |
| Citigo 3dr (2018>)   | X | • | X | • | - | - | - |
| Citigo 5dr (2018>)   | X | • | X | • | - | - | - |
| Fabia (1999 - 2007)  | X | • | X | • | - | - | - |
| Fabia (2015>)  | X | • | X | • | - | - | - |
| Fabia (2018>)  | X | • | X | • | - | - | - |
| Fabia Hatch (2007>)  | X | • | X | • | - | - | - |
| Fabia Estate Combi (2008>)   | X | • | X | • | - | - | - |
| Karoq (2018>)  | X | • | X | • | - | - | - |
| Kodiaq (2018>)   | X | • | X | • | - | - | - |
| Octavia (1996 - 2004)  | X | • | X | • | - | - | - |
| Octavia Hatch (2004 - 2012)  | X | • | X | • | - | - | - |
| Octavia Hatch (2013>)  | X | • | X | • | - | - | - |
| Octavia Hatch (2018>)  | X | • | X | • | - | - | - |
| Octavia Estate Combi (2005 - 2013)   | X | • | X | • | - | - | - |
| Octavia Estate (2018>)   | X | • | X | • | - | - | - |
| Octavia Scout (2007 - 2013)  | X | • | X | • | - | - | - |
| Rapid (2013>)  | X | • | X | • | - | - | - |
| Rapid (2018>)  | X | • | X | • | - | - | - |
| Roomster (2006>)   | X | • | X | • | - | - | - |
| Superb (2001 - 2008)   | X | • | X | • | - | - | - |
| Superb (2008 - 2014)   | X | • | X | • | - | - | - |
| Superb (2015>)   | X | • | X | • | - | - | - |
|  Superb Hatch (2018>) | X | • | X | • | - | - | - |

|                             |   |   |   |   |   |   |   |
|-----------------------------|---|---|---|---|---|---|---|
| Superb Combi/Estate (2008>) | X | • | X | • | - | - | - |
| Superb Estate (2018>)       | X | • | X | • | - | - | - |
| Yeti (2009>)                | X | • | X | • | - | - | - |

Smart

|                             |   |   |   |   |   |   |   |
|-----------------------------|---|---|---|---|---|---|---|
| For Two Coupe (2007 - 2011) | X | - | - | - | - | - | - |
| For Two Coupe (2018>)       | X | - | - | - | - | - | - |
| FourFour (2004 - 2006)      | X | • | X | • | - | - | - |
| FourFour (2015>)            | X | • | X | • | - | - | - |
| FourFour (2018>)            | X | • | X | • | - | - | - |

Ssangyong

|                      |   |   |   |   |   |   |   |
|----------------------|---|---|---|---|---|---|---|
| Actyon (2006 - 2011) | X | • | X | • | - | - | - |
| Korando (2011>)      | X | • | X | • | - | - | - |
| Kyron (2005 - 2011)  | X | • | X | • | - | - | - |
| Musso Pickup (2016>) | X | • | X | • | - | - | - |
| Rexton (2014>)       | X | • | X | • | - | - | - |
| Tivoli (2016>)       | X | • | X | • | - | - | - |
| Turismo (2014>)      | X | • | - | - | X | X | X |

Subaru

|                           |   |   |   |   |   |   |   |
|---------------------------|---|---|---|---|---|---|---|
| BRZ (2012>)               | X | • | - | • | - | - | - |
| Forester (2003 - 2008)    | X | • | X | • | - | - | - |
| Forester (2013>)          | X | • | X | • | - | - | - |
| Impreza 5dr (2007 - 2012) | X | • | X | • | - | - | - |
| Impreza 5dr (2013>)       | X | • | X | • | - | - | - |
| Justy (2004)              | X | • | X | • | - | - | - |
| Legacy (2012>)            | X | • | X | • | - | - | - |
| Legacy (2004)             | X | • | X | • | - | - | - |
| Outback (2012>)           | X | • | X | • | - | - | - |
| Sedan (2002- 2004)        | X | • | X | • | - | - | - |
| Wagon (2002- 2004)        | X | • | X | • | - | - | - |
| XV Hatchback (2011>)      | X | • | X | • | - | - | - |

Suzuki

|   |                      |   |   |   |   |   |   |   |
|---|----------------------|---|---|---|---|---|---|---|
|  | Alto (2009>)         | X | • | X | • | - | - | - |
|   | Baleno (2016>)       | X | • | X | • | - | - | - |
|   | Grand Vitara (2002>) | X | • | X | • | - | - | - |
|   | Grand Vitara (2005>) | X | • | X | • | - | - | - |
|   | Ignis (2004)         | X | • | X | • | - | - | - |
|   | Kizashi (2010)       | X | • | X | • | - | - | - |
|   | Liana (2002)         | X | • | X | • | - | - | - |
|   | Splash (2007>)       | X | • | X | • | - | - | - |
|   | Swift (2004)         | X | • | X | • | - | - | - |
|   | Swift Sport (2011>)  | X | • | X | • | - | - | - |
|   | SX-4 (2006>)         | X | • | X | • | - | - | - |
|   | SX-4 Saloon (2009>)  | X | • | X | • | - | - | - |
|   | Vitara (2015>)       | X | • | X | • | - | - | - |
|   | Wagon R+ (2002)      | X | • | X | • | - | - | - |

TATA







|  |                     |   |   |   |   |   |   |   |
|--|---------------------|---|---|---|---|---|---|---|
|  | Indica Vista (2008) | X | • | X | • | - | - | - |
|--|---------------------|---|---|---|---|---|---|---|

Tesla

|   |                 |   |   |   |   |   |   |   |
|---|-----------------|---|---|---|---|---|---|---|
|  | Model S (2014>) | X | • | X | • | - | - | - |
|  | Model X (2016>) | X | • | X | • | • | X | • |

Toyota

|  |                             |   |   |   |   |   |   |   |
|--|-----------------------------|---|---|---|---|---|---|---|
|  | Auris (2007 - 2012)         | X | • | X | • | - | - | - |
|  | Auris (2013>)               | X | • | X | • | - | - | - |
|  | Avensis Hatch (2003 - 2011) | X | • | X | • | - | - | - |
|  | Avensis Tourer (2009>)      | X | • | X | • | - | - | - |
|  | Aygo (2018>)                | X | • | • | • | - | - | - |
|  | Aygo (2014>)                | X | • | • | • | - | - | - |
|  | Aygo 3dr (2005 - 2014)      | X | • | • | • | - | - | - |
|  | Camry (2001)                | X | • | X | • | - | - | - |
|  | Corolla (2002 - 2007)       | X | • | X | • | - | - | - |
|  | C-HR (2017>)                | X | • | X | • | - | - | - |
|  | EZ MPV (2013>)              | X | • | X | • | - | - | - |
|  | GT86 (2012>)                | X | • | • | • | - | - | - |
|  |                             | X | X | - | X | - | - | - |



|  |   |   |   |   |   |   |   |   |
|--|---|---|---|---|---|---|---|---|
|  | Highlander (2013>)  | X | • | X | • | - | - | - |
|  | IQ (2009)   | X | • | X | • | - | - | - |
|  | Landcruiser (2002 - 2009)   | X | • | X | • | - | - | - |
|  | Landcruiser (2009>)   | X | • | X | • | - | - | - |
|  | Landcruiser (2018>)   | X | • | X | • | - | - | - |
|  | Previa (2000 - 2009)  | X | • | X | • | - | - | - |
|  |  Prius (2010>)         | X | • | X | • | - | - | - |
|  |  Prius (2018>)         | X | • | X | • | - | - | - |
|  |  Prius 2 (2004 - 2010) | X | • | X | • | - | - | - |
|  |  Prius 3 (2010 - 2016) | X | • | X | • | - | - | - |
|  |  Prius 4 (2016>)       | X | • | X | • | - | - | - |
|  |  Prius Plus+ (2012>)   | X | • | X | • | - | - | - |
|  |  Prius PHEV 3 (2015>)  | X | • | X | • | - | - | - |
|  | RAV4 (2000 - 2006)  | X | • | X | • | - | - | - |
|  | RAV4 (2013>)  | X | • | X | • | - | - | - |
|  | RAV4 (2018>)  | X | • | X | • | - | - | - |
|  | RAV4 MK3 (2006 - 2011)  | X | • | X | • | - | - | - |
|  | Urban Cruiser (2009)  | X | • | X | • | - | - | - |
|  | <b>SB!</b> Verso (2009 - 2012)  | X | ! | X | ! | - | - | - |
|  | Verso (2012>)   | X | X | X | X | - | - | - |
|  | Yaris (1999 - 2005)   | X | • | X | • | - | - | - |
|  | Yaris (2008 - 2011)   | X | • | X | • | - | - | - |
|  | Yaris Hatch (2011>)   | X | • | X | • | - | - | - |
|  | Yaris Hatch (2018>)   | X | • | X | • | - | - | - |





Vauxhall

|  |  |   |   |   |   |   |   |   |
|--|--|---|---|---|---|---|---|---|
|  | Adam (2013>)   | X | • | • | • | - | - | - |
|  | Agila (2002)   | X | • | X | • | - | - | - |
|  | Agila (2008>)  | X | • | X | • | - | - | - |
|  |  Ampera (2011>) | X | • | • | • | - | - | - |
|  | Antara (2006 - 2015)   | X | • | X | • | - | - | - |
|  | Astra (2004 - 2010)  | X | • | X | • | - | - | - |
|  | Astra (2015>)  | X | • | X | • | - | - | - |
|  | Astra 5 dr (2010>)   | X | • | X | • | - | - | - |
|  | Astra Estate (2010>)   | X | • | X | • | - | - | - |
|  | Astra 5dr Sport Tourer (2018>)   | X | • | X | • | - | - | - |
|  | Astra GTC (2011>)  | X | • | X | • | - | - | - |
|  | Caravan (2004)   | X | • | X | • | - | - | - |

|   |   |   |   |   |   |   |   |
|---|---|---|---|---|---|---|---|
| Combo (2001)  | X | • | X | • | - | - | - |
| Corsa 3dr Hatch (2006 - 2015)   | X | • | X | • | - | - | - |
| Corsa 5dr Hatch (2006 - 2015)   | X | • | X | • | - | - | - |
| Corsa 5dr (2015>)   | X | • | X | • | - | - | - |
| Corsa 3dr (2018>)   | X | • | X | • | - | - | - |
| Corsa 5dr (2018>)   | X | • | X | • | - | - | - |
|  Corsa C (2000)  | X | • | X | • | - | - | - |
|  Corsa D (2006>) | X | • | X | • | - | - | - |
| Corsa VXR (2007>)   | X | • | X | • | - | - | - |
| Crossland X (2018>)   | X | • | X | • | - | - | - |
| Grandland X (2018>)   | X | • | X | • | - | - | - |
| Insignia Hatch (2008>)  | X | • | X | • | - | - | - |
| Insignia Saloon (2009>)   | X | • | X | • | - | - | - |
| Insignia Sports Tourer (2009>)  | X | • | X | • | - | - | - |
| Insignia (2018>)  | X | • | X | • | - | - | - |
| Karl (2015>)  | X | • | X | • | - | - | - |
| Meriva (2002)   | X | • | X | • | - | - | - |
| Meriva (2010>)  | X | • | X | • | - | - | - |
| Mokka (2012>)   | X | • | X | • | - | - | - |
| Mokka X (2018>)   | X | • | X | • | - | - | - |
| Signum (2003 - 2008)  | X | • | X | • | - | - | - |
| Vectra (2002 - 2008)  | X | • | X | • | - | - | - |
| Vectra (2015>)  | X | • | X | • | - | - | - |
| Vivaro (2001)   | X | • | X | • | - | - | - |
| Viva (2015>)  | X | • | X | • | - | - | - |
| Viva (2018>)  | X | • | X | • | - | - | - |
| Zafira (2005 - 2014)  | X | • | X | • | - | - | - |
| Zafira Tourer (2012>)   | X | • | X | • | X | - | X |
| Zafira VXR (2005>)  | X | • | X | • | - | - | - |





Volvo



|  |   |   |   |   |   |   |   |
|--|---|---|---|---|---|---|---|
| C30 (2006 - 2013)  | X | • | - | • | - | - | - |
| C70 (2005)   | X | • | X | • | - | - | - |
| S40 (2003 - 2012)  | X | • | X | • | - | - | - |
| S60 (2010>)  | X | • | X | • | - | - | - |
|  S80 (2006>)  | X | • | X | • | - | - | - |
|  S90 (2016>) | X | • | X | • | - | - | - |
| V40 (1996 - 2004)  | X | • | X | • | - | - | - |

|  |   |   |   |   |   |   |   |
|--|---|---|---|---|---|---|---|
| V40 (2012>)  | X | • | X | • | - | - | - |
| V40 Cross Country (2013>)  | X | • | X | • | - | - | - |
| V40 (2018>)  | X | • | X | • | - | - | - |
| V50 (2004 - 2012)  | X | • | X | • | - | - | - |
| V60 (2010>)  | X | • | X | • | - | - | - |
|  V60 PHEV (2015>) | X | • | X | • | - | - | - |
| V60 (2018>)  | X | • | X | • | - | - | - |
|  V70 (2008>)      | X | • | X | • | - | - | - |
|  V90 (2016>)      | X | • | X | • | - | - | - |
| V90 Cross-Country (2016>)  | X | • | X | • | - | - | - |
| V90 Cross-Country (2018>)  | X | • | X | • | - | - | - |
| XC40 (2018>)   | X | • | X | • | - | - | - |
| XC60 (2008>)   | X | • | X | • | - | - | - |
| XC60 (2013>)   | X | • | X | • | - | - | - |
| XC60 (2018>)   | X | • | X | • | - | - | - |
| XC70 (2000 - 2007)   | X | • | X | • | - | - | - |
| XC70 (2007>)   | X | • | X | • | - | - | - |
| XC90 (2002 - 2015)   | X | • | X | • | - | - | - |
|  XC90 (2016>)     | X | • | X | • | X | - | X |
|  XC90 (2018>)     | X | • | X | • | - | - | - |

VW

|  |   |   |   |   |   |   |   |
|--|---|---|---|---|---|---|---|
| Amarok (2010)  | X | • | X | • | - | - | - |
| Beetle (2012>)   | X | • | - | • | - | - | - |
| Bora (1998 - 2005)   | X | • | X | • | - | - | - |
| Caddy (2000 - 2010)  | X | • | X | • | - | - | - |
| Caddy Maxlife (2010 - 2015)  | X | • | X | • | X | - | X |
| E-Golf Hatch Mk7 (2014>)   | X | • | X | • | - | - | - |
| EOS (2006)   | X | • | X | • | - | - | - |
| EOS (2010)   | X | • | X | • | X | - | - |
| Fox (2005)   | X | • | X | • | - | - | - |
|  Golf E (2014>) | X | • | X | • | - | - | - |
| Golf 4 (1997 - 2003)   | X | • | X | • | - | - | - |
| Golf 4 Variant (1996 - 2006)   | X | • | X | • | - | - | - |
| Golf Hatch Mk5 (2004 - 2008)   | X | • | X | • | - | - | - |
| Golf Mk5 (2006 - 2009)   | X | • | X | • | - | - | - |
| Golf Hatch (2008 - 2012)   | X | • | X | • | - | - | - |
| Golf Hatch MK7 (2012>)   | X | • | X | • | - | - | - |

|   |   |   |   |   |   |   |   |
|---|---|---|---|---|---|---|---|
| ⚡ Golf Cabriolet (2009 - 2012)  | X | • | - | • | - | - | - |
| ⚡ Golf GTE Hatch MK7 (2014>)  | X | • | X | • | - | - | - |
| Golf GTI (2009 - 2012>)   | X | • | X | • | - | - | - |
| Golf GTI (2018>)  | X | • | X | • | - | - | - |
| Golf Plus (2009 - 2011)   | X | • | X | • | - | - | - |
| Golf SV (2017)  | X | • | X | • | - | - | - |
| Golf (2018>)  | X | • | X | • | - | - | - |
| Jetta (2011>)   | X | • | X | • | - | - | - |
| Lupo (1999 - 2005)  | X | • | - | • | - | - | - |
| LT (1999)   | X | • | X | • | - | - | - |
| Multivan Caravelle (2003>)  | X | • | - | - | • | • | • |
| Multivan Caravelle (2008>)  | X | • | - | - | • | • | • |
| New Beetle (1998 - 2002)  | X | • | X | • | - | - | - |
| Passat (1996 - 2005)  | X | • | X | • | - | - | - |
| Passat (2005 - 2010)  | X | • | X | • | - | - | - |
| Passat (2010 - 2015)  | X | • | X | • | - | - | - |
|  Passat Estate (2005 - 2011) | X | • | X | • | - | - | - |
|  Passat Estate (2011 - 2015) | X | • | X | • | - | - | - |
|  Passat Estate (2015>)       | X | • | X | • | - | - | - |
|  Passat Saloon (2015>)       | X | • | X | • | - | - | - |
| Passat (2018>)  | X | • | X | • | - | - | - |
| Passat Alltrack (2012>)   | X | • | X | • | - | - | - |
| Passat CC (2008>)   | X | • | X | • | - | - | - |
| Phaeton (2002)  | X | • | X | • | - | - | - |
| Polo 3 (1994 - 2001)  | X | • | X | • | - | - | - |
| Polo 4 (2005 - 2009)  | X | • | X | • | - | - | - |
| Polo 5 (2009)   | X | • | X | • | - | - | - |
| Polo 3dr (2009>)  | X | • | X | • | - | - | - |
| Polo 5dr (2009>)  | X | • | X | • | - | - | - |
| Polo 5dr (2018>)  | X | • | X | • | - | - | - |
| Polo GTI (2018>)  | X | • | X | • | - | - | - |
| Scirocco (2008)   | X | • | X | • | - | - | - |
| Scirocco (2011)   | X | • | - | • | - | - | - |
| Sharan (1998)   | X | • | • | • | • | • | • |
| Sharan (2004)   | X | • | • | • | • | • | • |
| SB! Sharan (2010>)  | X | ! | X | ! | X | - | X |
| SB! Sharan (2018>)  | X | ! | • | ! | • | • | • |
| T4 Caravelle (1999)   | X | • | • | X | X | X | X |
| Multivan (1999 - 2003)  | X | • | X | • | - | - | • |

|   |   |   |   |   |   |   |   |
|---|---|---|---|---|---|---|---|
| T5 Kombi (2003)   | X | • | • | X | - | - | - |
| Multivan (2003)   | X | • | X | • | - | - | • |
| Tiguan (2007 - 2016)  | X | • | X | • | - | - | - |
|  Tiguan (2016>)          | X | • | X | • | - | - | - |
|  Touareg (2002 - 2010)   | X | • | X | • | - | - | - |
| Touareg (2010>)   | X | • | X | • | - | - | - |
| Touareg (2012>)   | X | • | X | • | - | - | - |
| Touareg (2018>)   | X | • | X | • | - | - | - |
| Touareg MK 1 (2009)   | X | • | X | • | - | - | - |
| Touran (2003 - 2010)  | X | • | X | • | - | - | - |
|  SB! Touran (2010 - 2015) | X | ! | X | ! | X | - | X |
| Touran (2016>)  | X | • | • | • | X | - | X |
| Transporter LT3 (2006)  | X | • | X | • | - | - | - |
| T-Roc (2018>)   | X | • | X | • | - | - | - |
| UP! (2011>)   | X | • | X | • | - | - | - |
| ⚡ E - UP! (2014>)   | X | • | X | • | - | - | - |
| ⚡ E - UP! 3dr (2018>)   | X | • | X | • | - | - | - |
| ⚡ E - UP! 5dr (2018>)   | X | • | X | • | - | - | - |

## ISOFIX Fit

① ② ③ ④ ⑤ ⑥ ⑦

### Alfa Romeo

|                       |   |   |   |   |   |   |   |
|-----------------------|---|---|---|---|---|---|---|
| Giulia (2018>)        | X | • | X | • | - | - | - |
| Guilietta (2018>)     | X | • | X | • | - | - | - |
| Guilietta (2010>)     | X | • | X | • | - | - | - |
| MiTo (2018>)          | X | • | - | • | - | - | - |
| MiTo (2009>)          | X | • | - | • | - | - | - |
| Stelvio (2018>)       | X | • | X | • | - | - | - |
| 156 Sportwagon (2005) | X | • | X | • | - | - | - |
| 159 (2011)            | X | • | X | • | - | - | - |

### Audi

|                               |   |   |   |   |   |   |   |
|-------------------------------|---|---|---|---|---|---|---|
| A1 (2011>)                    | X | • | X | • | - | - | - |
| A1 Sportback (2012>)          | X | • | X | • | - | - | - |
| A1 Sportback (2018>)          | X | • | X | • | - | - | - |
| ⚡ A3 e-Tron Sportback (2015>) | X | • | X | • | - | - | - |
| A3 Hatch (2012>)              | X | • | X | • | - | - | - |
| A3 S3 (2012>)                 | X | • | X | • | - | - | - |
| A3 (2018>)                    | X | • | X | • | - | - | - |
| A3/S3 Saloon (2014>)          | X | • | X | • | - | - | - |
| A3 Saloon (2018>)             | X | • | X | • | - | - | - |
| A3 (2004 - 2011)              | X | • | X | • | - | - | - |
| 🚗 A3 (1996 - 2003)            | X | • | X | • | - | - | - |
| 🚗 A4 Avant (2016>)            | X | • | X | • | - | - | - |
| A4/S4 (2015>)                 | X | • | X | • | - | - | - |
| A4/S4 (2009>)                 | X | • | X | • | - | - | - |
| A4 (2005 - 2009)              | X | • | X | • | - | - | - |
| A4/S4 Avant (2008 - 2016)     | X | • | X | • | - | - | - |
| A4/S4 Saloon (2008 - 2016)    | X | • | X | • | - | - | - |
| 🚗 A4 Saloon (2018>)           | X | • | X | • | - | - | - |
| A4 (2015>)                    | X | • | X | • | - | - | - |
| A4 Allroad (2008 - 2016)      | X | • | X | • | - | - | - |
| A5 (2018>)                    | X | • | - | • | - | - | - |
| A5 (2016>)                    | X | • | X | • | - | - | - |
| A5 (2007>)                    | X | • | X | • | - | - | - |
| A5 Cabriolet (2018>)          | X | • | X | • | - | - | - |
| A5/S5 Coupe (2016>)           | X | • | - | • | - | - | - |
| A5 Coupe (2006 - 2016)        | X | • | - | • | - | - | - |
| A5 Coupe (2018>)              | X | • | - | • | - | - | - |
| A5/S5 Sportback (2017>)       | X | • | X | • | - | - | - |



① ② ③ ④ ⑤ ⑥ ⑦

|                               |   |   |   |   |   |   |   |
|-------------------------------|---|---|---|---|---|---|---|
| A5/S5 Sportback (2007 - 2016) | X | • | X | • | - | - | - |
| A5 Sportback (2007>)          | X | • | X | • | - | - | - |
| A6 Allroad (2016>)            | X | • | X | • | - | - | - |
| A6 (2011>)                    | X | • | X | • | - | - | - |
| A6 Allroad (2011>)            | X | • | X | • | - | - | - |
| A6 Avant (2011>)              | X | • | X | • | - | - | - |
| A6/S6 (2011>)                 | X | • | X | • | - | - | - |
| A6/S6 (2016>)                 | X | • | X | • | - | - | - |
| A7 Sportback (2018>)          | X | • | X | • | - | - | - |
| A7/S7 Sportback (2016>)       | X | • | X | • | - | - | - |
| A7 Sportback (2011>)          | X | • | X | • | - | - | - |
| A8/S8 (2011>)                 | X | • | X | • | - | - | - |
| A8 (2011>)                    | X | • | X | • | - | - | - |
| 🚗 A8 (2018>)                  | X | • | X | • | - | - | - |
| 🚗 Q2 (2016>)                  | X | • | X | • | - | - | - |
| Q3 (2013>)                    | X | • | X | • | - | - | - |
| Q3 (2018>)                    | X | • | X | • | - | - | - |
| Q5/SQ5 (2012 - 2016)          | X | • | X | • | - | - | - |
| Q5 (2008 - 2012)              | X | • | X | • | - | - | - |
| Q5 (2018>)                    | X | • | X | • | - | - | - |
| 🚗 Q7 (2006 - 2016)            | X | • | X | • | - | - | - |
| 🚗 Q7/SQ7 (2015>)              | X | • | X | • | X | - | X |
| S1 (2014)                     | X | • | X | • | - | - | - |
| TT Coupe Sport (2015>)        | X | • | X | • | - | - | - |
| TT Coupe (2012>)              | X | X | - | X | - | - | - |
| TT Coupe (2006>)              | X | X | - | X | - | - | - |

### Bentley

|                                 |   |   |   |   |   |   |   |
|---------------------------------|---|---|---|---|---|---|---|
| Continental Flying Spur (2005>) | X | • | X | • | - | - | - |
| Continental GT (2003 - 2012)    | X | • | - | • | - | - | - |
| Continental GTC (2005 - 2012)   | X | • | - | • | - | - | - |
| Mulsanne (2010>)                | X | • | X | • | - | - | - |
| Mulsanne (2012>)                | X | • | X | • | - | - | - |

**BMW**

|  |   |   |   |   |   |   |   |
|--|---|---|---|---|---|---|---|
| 1 Series F20 (2011>)   | X | • | X | • | - | - | - |
| 1-Series 5dr (2004 - 2011)   | X | • | X | • | - | - | - |
| 1-Series Convertible (2008 - 2015)   | X | • | - | • | - | - | - |
| 1-Series Coupe (2008 - 2015)   | X | • | - | • | - | - | - |
| 2-Series AC-T (2015>)  | X | • | X | • | - | - | - |
| 2-Series Coupe (2014>)   | X | • | - | • | - | - | - |
| 2-Series Gran Tourer (2018>)   | X | • | X | • | - | - | - |
| 3-GT (2013>)   | X | • | X | • | - | - | - |
| 3 Series F30 (2012>)   | X | • | X | • | - | - | - |
| 3-Series (2005 - 2011)   | X | • | - | • | - | - | - |
| 3-Series Coupe (2007- 2014)  | X | • | - | • | - | - | - |
| 3-Series M Sport (2018>)   | X | • | - | • | - | - | - |
| 4-Series Gran Coupe (2014>)  | X | • | X | • | - | - | - |
| 5-GT (2010>)   | X | • | X | • | - | - | - |
| 5-Series (2008 - 2010)   | X | • | X | • | - | - | - |
| 5-Series (2011>)   | X | • | X | • | - | - | - |
| 5-Series M (2005 - 2011)   | X | • | X | • | - | - | - |
| 5-Series Saloon (2011>)  | X | • | X | • | - | - | - |
| 5-Series Saloon (2003 - 2010)  | X | • | X | • | - | - | - |
| 5-Series Touring (2011>)   | X | • | X | • | - | - | - |
| 5-Series Touring (2003 - 2010)   | X | • | X | • | - | - | - |
| 6-Series Coupe (2Dr) (2011>)   | X | • | - | • | - | - | - |
| 6-Series Convertible (2011>)   | X | • | - | • | - | - | - |
| 6-Series Gran Coupe (4Dr) (2011>)  | X | • | X | • | - | - | - |
| 6-GT (2018>)   | X | • | X | • | - | - | - |
| 7-Series (2010>)   | X | • | X | • | - | - | - |
| 7-Series (2016>)   | X | • | X | • | - | - | - |
| M5 (2011)  | X | • | X | • | - | - | - |
| M Sport Saloon (2018>)   | X | • | X | • | - | - | - |
|  i3 (2014>)       | X | • | - | • | - | - | - |
|  X1 (2009 - 2015) | X | • | X | • | - | - | - |
| X1 (2016>)   | X | • | X | • | - | - | - |
| X2 (2018>)   | X | • | X | • | - | - | - |
| X3 F25 (2011>)   | X | • | X | • | - | - | - |
| X4 (2014>)   | X | • | X | • | - | - | - |
| X5 (2007- 2014)  | X | • | X | • | X | - | X |
| X5 (2015>)   | X | • | X | • | X | - | X |
| X5 (2018>)   | X | • | X | • | X | - | X |
| X5 M (2018>)   | X | • | X | • | X | - | X |

**Cadillac**

|              |   |   |   |   |   |   |   |
|--------------|---|---|---|---|---|---|---|
| X6 (2008>)   | X | • | X | • | - | - | - |
| X6 (2015>)   | X | • | - | • | - | - | - |
| X6 M (2008>) | X | • | X | • | - | - | - |

|                          |   |   |   |   |   |   |   |
|--------------------------|---|---|---|---|---|---|---|
| BLS Saloon (2006 - 2011) | X | • | X | • | - | - | - |
| CTS (2007)               | X | • | X | • | - | - | - |

**Chevrolet**

|                     |   |   |   |   |   |   |   |
|---------------------|---|---|---|---|---|---|---|
| Aveo 5 door (2012>) | X | • | X | • | - | - | - |
| Captiva (2007>)     | X | • | X | • | - | - | - |
| Camaro (2011)       | X | • | X | • | - | - | - |
| Cruze (2009>)       | X | • | X | • | - | - | - |
| Cruze (2012>)       | X | • | X | • | - | - | - |
| Epica (2006)        | X | • | X | • | - | - | - |
| HHR (2009)          | X | • | X | • | - | - | - |
| Kalos (2002)        | X | • | X | • | - | - | - |
| Lacetti (2004)      | X | • | X | • | - | - | - |
| Malibu (2012)       | X | • | X | • | - | - | - |
| Matiz (2005 - 2009) | X | • | X | • | - | - | - |
| Matiz (2006)        | X | • | X | • | - | - | - |
| Nubira (2009)       | X | • | X | • | - | - | - |
| Orlando (2011>)     | X | • | X | • | - | - | - |
| Spark (2012>)       | X | • | X | • | - | - | - |
| Traxx (2013>)       | X | • | X | • | - | - | - |
| Volt (2011>)        | X | • | - | • | - | - | - |

**Chrysler**

|                       |   |   |   |   |   |   |   |
|-----------------------|---|---|---|---|---|---|---|
| 300C (2012>)          | X | • | X | • | - | - | - |
| Delta (2011>)         | X | • | X | • | - | - | - |
| Delta (2007>)         | X | • | X | • | - | - | - |
| Dodger Avenger (2007) | X | • | X | • | - | - | - |
| Dodger Caliber (2006) | X | • | X | • | - | - | - |
| Dodger Journey (2009) | X | • | • | • | - | - | - |
| Dodger Nitro (2006)   | X | • | X | • | - | - | - |
| Dodge Ram (2008)      | X | • | • | • | - | - | - |

|                       |   |   |   |   |   |   |   |
|-----------------------|---|---|---|---|---|---|---|
| Pacifica (2008)       | X | . | X | . | - | - | - |
| PT Cruiser (2010)     | X | . | X | . | - | - | - |
| Sebring (2007)        | X | . | X | . | - | - | - |
| Grand Voyager (2008>) | X | . | - | . | X | X | X |
| Voyager (2007)        | X | . | X | . | . | - | . |
| Ypsilon (2011>)       | X | . | X | . | - | - | - |

## Citroen

|   |   |   |   |   |   |   |   |
|---|---|---|---|---|---|---|---|
| Berlingo II (2008>)   | X | . | X | . | - | - | - |
| SB! Berlingo Multispace (2007>)   | X | ! | X | ! | X | - | X |
| Berlingo Multispace (2009)  | . | X | . | X | - | - | - |
| C1 (2005 - 2015)  | X | . | - | . | - | - | - |
| C1 (2015>)  | X | . | - | . | - | - | - |
| C2 (2004)   | X | . | X | . | - | - | - |
| C3 5Dr (2005 - 2009)  | X | . | X | . | - | - | - |
| C3 5Dr (2009 - 2016)  | X | . | X | . | - | - | - |
| SB! C3 5Dr (2017>)  | X | ! | X | ! | - | - | - |
| SB! C3 Picasso (2009>)  | X | ! | X | ! | - | - | - |
| C4 (2010>)  | X | . | X | . | - | - | - |
| SB! C4 G-Picasso (2007 - 2013)  | X | ! | . | ! | X | - | X |
| SB! C4 Picasso (2007 - 2014)  | X | ! | X | ! | X | X | X |
| SB! C4 Picasso (2014>)  | X | ! | . | ! | X | X | X |
| SB! C4 Picasso (2017>)  | X | ! | . | ! | X | - | X |
|  C4-Cactus (2015>) | X | . | X | . | - | - | - |
| C5 (2005 - 2008)  | X | . | X | . | - | - | - |
| C5 (2006 - 2010)  | X | . | X | . | - | - | - |
| C5 Saloon (2008>)   | X | . | X | . | - | - | - |
| C5 Tourer (2008>)   | X | . | X | . | - | - | - |
| C-Crosser (2007 - 2013)   | X | . | X | . | - | - | - |
| DS3 (2010>)   | X | . | X | . | - | - | - |
| DS3 Cabrio (2016>)  | X | . | X | . | - | - | - |
| DS4 (2011>)   | X | . | X | . | - | - | - |
| DS5 (2012>)   | X | . | X | . | - | - | - |
| Evasion (2002)  | X | . | X | . | . | X | . |
| Jumpy (2007 - 2012)   | X | . | X | . | X | X | X |
| Nemo (2008>)  | X | . | X | . | - | - | - |
| Saxo (2003)   | X | . | X | . | - | - | - |
| Xsara (2000 - 2006)   | X | X | X | X | - | - | - |

## Dacia

|                   |   |   |   |   |   |   |   |
|-------------------|---|---|---|---|---|---|---|
| Dokker (2012)     | X | . | . | . | - | - | - |
| Duster (2012>)    | X | . | X | . | - | - | - |
| Duster (2018>)    | X | . | X | . | - | - | - |
| Lodgy (2012)      | X | . | . | . | - | - | - |
| Logan MCV (2013>) | X | . | X | . | - | - | - |
| Logan MCV (2018>) | X | . | X | . | - | - | - |
| Sandero (2013>)   | X | . | X | . | - | - | - |
| Sandero (2018>)   | X | . | X | . | - | - | - |

## Daihatsu









|                |   |   |   |   |   |   |   |
|----------------|---|---|---|---|---|---|---|
| Cuore (2007)   | X | . | X | . | - | - | - |
| Materia (2006) | X | . | X | . | - | - | - |
| Sirion (2005)  | X | . | X | . | - | - | - |
| Terios (2005)  | X | . | X | . | - | - | - |
| Trevis (2005)  | X | . | X | . | - | - | - |



## Fiat

|  |   |   |   |   |   |   |   |
|--|---|---|---|---|---|---|---|
| 124 Spider (2016>)   | X | . | - | - | - | - | - |
| 500 (2008>)  | X | . | - | - | - | - | - |
| 500 C (2009>)  | X | . | - | - | - | - | - |
|  500L (2013>) | X | . | X | . | - | - | - |
| 500X (2015>)   | X | . | X | . | - | - | - |
| Abarth 500 (2009>)   | X | . | - | - | - | - | - |
| Abarth Grande Punto (2008 - 2011)  | X | . | X | . | - | - | - |
| Abarth 595 (2018>)   | X | . | - | - | - | - | - |
| GBT Punto (2014>)  | X | . | X | . | - | - | - |
| Bravo (2007>)  | X | . | X | . | - | - | - |
| Croma (2008)   | X | . | X | . | - | - | - |
| Doblo (2007)   | X | . | X | . | - | - | - |
| Doblo (2010>)  | X | . | X | . | - | - | - |
| Grande Punto (2006>)   | X | . | X | . | - | - | - |
| Idea (2007)  | X | . | X | . | - | - | - |
| Linea (2007)   | X | . | X | . | - | - | - |
| Multipla (2007)  | X | . | X | . | - | - | - |
| Panda (2012>)  | X | . | X | . | - | - | - |
| Qubo (2008>)   | X | . | X | . | - | - | - |
| Scudo II (2007)  | X | . | X | . | . | X | . |

|   |               |   |   |   |   |   |   |   |
|---|---------------|---|---|---|---|---|---|---|
|   | Sedici (2006) | X | • | X | • | - | - | - |
|  | Stilo (2007)  | X | • | X | • | - | - | - |
|   | Tipo (2016>)  | X | • | X | • | - | - | - |
|   | Tipo (2018>)  | X | • | X | • | - | - | - |
|   | Ulysse (2003) | X | • | • | • | • | X | • |

Ford



|  |                          |   |   |   |   |   |   |   |
|--|--------------------------|---|---|---|---|---|---|---|
|   | B-Max (2012>)            | X | • | X | • | - | - | - |
|  | C-Max (2003 - 2010)      | X | X | X | X | - | - | - |
|  | C-Max (2010 - 2012)      | X | X | X | X | - | - | - |
|   | C-Max (2012>)            | X | • | X | • | - | - | - |
|  | C-Max (2018>)            | X | • | X | • | - | - | - |
|  | Grand C-Max (2012)       | X | • | X | • | - | - | - |
|   | Grand C-Max (2018>)      | X | • | X | • | - | - | - |
|  | EcoSport (2015>)         | X | • | X | • | - | - | - |
|   | EcoSport (2018>)         | X | • | X | • | - | - | - |
|  | Edge (2016>)             | X | • | X | • | X | - | X |
|  | Edge Sport (2018>)       | X | • | X | • | - | - | - |
|  | Fiesta (2004 - 2008)     | X | X | X | X | - | - | - |
|  | Fiesta (2008>)           | X | • | X | • | - | - | - |
|  | Fiesta 3dr (2016>)       | X | • | X | • | - | - | - |
|  | Fiesta 3dr (2018>)       | X | • | X | • | - | - | - |
|  | Fiesta 5dr (2016>)       | X | • | X | • | - | - | - |
|  | Fiesta 5dr (2018>)       | X | • | X | • | - | - | - |
|  | Fiesta Active (2018>)    | X | • | X | • | - | - | - |
|  | Focus (1998 - 2005)      | X | X | X | X | - | - | - |
|  | Focus (2005 - 2009)      | X | X | X | X | - | - | - |
|   | Focus (2010 - 2015)      | X | • | X | • | - | - | - |
|  | Focus (2015>)            | X | • | X | • | - | - | - |
|  | Focus Estate (2017>)     | X | • | X | • | - | - | - |
|  | Focus ST Estate (2017>)  | X | • | X | • | - | - | - |
|   | Focus EV (2015>)         | X | • | X | • | - | - | - |
|  | Focus (2018>)            | X | • | X | • | - | - | - |
|   | SB! Galaxy (2006 - 2015) | X | ! | X | ! | X | - | X |
|  | Galaxy (2016>)           | X | • | X | • | X | - | X |
|   | SB! Galaxy (2017>)       | X | ! | • | ! | X | - | X |
|  | Ka (2009 - 2016)         | X | • | • | • | - | - | - |
|  | Ka+ (2016>)              | X | • | X | • | - | - | - |
|  | Ka+ (2018>)              | X | • | X | • | - | - | - |

|   |                                |   |   |   |   |   |   |   |
|---|--------------------------------|---|---|---|---|---|---|---|
|   | Kuga (2013>)                   | X | • | X | • | - | - | - |
|   | Kuga (2018>)                   | X | • | X | • | - | - | - |
|   | Maverick (2007)                | X | • | X | • | - | - | - |
|   | Mondeo (2002 - 2007)           | X | X | X | X | - | - | - |
|   | Mondeo Estate (2007 - 2015)    | X | • | X | • | - | - | - |
|   | Mondeo Estate (2017)           | X | • | X | • | - | - | - |
|   | Mondeo Hatchback (2007 - 2015) | X | • | X | • | - | - | - |
|   | Mondeo Saloon (2007 - 2015)    | X | • | X | • | - | - | - |
|  | Mondeo (2015>)                 | X | • | X | • | - | - | - |
|   | Mondeo (2007-2010)             | X | • | X | • | - | - | - |
|   | Mondeo Turnier (2010)          | X | • | X | • | - | - | - |
|   | Mondeo Vignale (2018>)         | X | • | X | • | - | - | - |
|   | Mondeo Ranger (2011)           | X | • | X | • | - | - | - |
|   | SB! S-Max (2006 - 2015)        | X | ! | X | ! | X | - | X |
|  | SB! S-Max (2014>)              | X | ! | X | ! | - | - | - |
|   | S-Max (2016>)                  | X | • | X | • | X | - | X |
|   | SB! S-Max (2018>)              | X | • | • | ! | X | - | X |
|   | Tourneo Connect (2013)         | X | • | X | • | - | - | - |
|   | Tourneo Custom (2012)          | X | • | • | X | - | - | - |
|   | Transit Connect (2006)         | X | • | • | X | - | - | - |
|   | Transit Kombi (2011)           | X | • | • | X | - | - | - |
|   | Transit Custom (2012)          | X | • | • | X | - | - | - |
|   | Transit Custom (2012)          | X | • | • | X | - | - | - |
|   | Vignale (2018>)                | X | • | X | • | - | - | - |

Honda

|  |                                   |   |   |   |   |   |   |   |
|--|-----------------------------------|---|---|---|---|---|---|---|
|  | Accord Saloon (2008>)             | X | • | X | • | - | - | - |
|  | Accord Tourer (2008>)             | X | • | X | • | - | - | - |
|  | City (2009)                       | X | • | X | • | - | - | - |
|  | Civic (2006 - 2011)               | X | • | X | • | - | - | - |
|  | Civic (2012>)                     | X | • | X | • | - | - | - |
|  | Civic (2018>)                     | X | • | X | • | - | - | - |
|  | Civic Hybrid Saloon (2006 - 2010) | X | • | X | • | - | - | - |
|  | Civic Type R (2007 - 2010)        | X | • | X | • | - | - | - |
|  | Civic Prestige (2006 - 2010)      | X | • | X | • | - | - | - |
|  | Civic Tourer (2014>)              | X | • | X | • | - | - | - |
|  | CR-V (2007 - 2013)                | X | • | X | • | - | - | - |
|  | CR-V (2012>)                      | X | • | X | • | - | - | - |



|  |   |   |   |   |   |   |   |
|--|---|---|---|---|---|---|---|
| CR-V S Plus (2018>)  | X | • | X | • | - | - | - |
| CR-Z (2010>)   | X | • | X | • | - | - | - |
| Elysion (2012>)  | X | • | - | • | X | - | X |
| FRV (2005 - 2011)  | X | • | X | • | - | - | - |
|  HR-V (2015>) | X | • | X | • | - | - | - |
| HR-V (2018>)   | X | • | X | • | - | - | - |
| Insight (2009>)  | X | X | X | X | - | - | - |
| Jazz (2001 - 2008)   | X | X | X | X | - | - | - |
| Jazz (2008 - 2015)   | X | • | X | • | - | - | - |
|  Jazz (2016>) | X | • | X | • | - | - | - |
| Jazz (2018>)   | X | • | X | • | - | - | - |
| Jazz Sport (2018>)   | X | • | X | • | - | - | - |
| Legend (2006 - 2010)   | X | • | X | • | - | - | - |
| Odyssey (2010>)  | X | X | - | X | - | - | - |

Hyundai

|   |   |   |   |   |   |   |   |
|---|---|---|---|---|---|---|---|
| Accent (2002)   | X | • | X | • | - | - | - |
| Coupe (2001)  | X | • | X | • | - | - | - |
| Elantra (2002)  | X | • | X | • | - | - | - |
| Excel (2002)  | X | • | X | • | - | - | - |
| Getz (2002 - 2005)  | X | • | X | • | - | - | - |
| Getz (2005 - 2011)  | X | • | X | • | - | - | - |
| Grandeur (2005)   | X | • | X | • | - | - | - |
| i10 (2008>)   | X | • | X | • | - | - | - |
| i10 Hatch (2018>)   | X | • | X | • | - | - | - |
| i20 (2015>)   | X | • | X | • | - | - | - |
| i20 Hatch (2009>)   | X | • | X | • | - | - | - |
| i30 (2012 - 2015)   | X | • | X | • | - | - | - |
| i30 (2015>)   | X | • | X | • | - | - | - |
| i30 (2018>)   | X | • | X | • | - | - | - |
| i40 (2011>)   | X | • | X | • | - | - | - |
| i40 (2018>)   | X | • | X | • | - | - | - |
|  i800/H1 (2008>) | X | • | X | • | X | X | X |
| Ioniq (2016>)   | X | • | X | • | - | - | - |
| iX20 (2010>)  | X | • | X | • | - | - | - |
| iX35 (2010>)  | X | • | X | • | - | - | - |
| iX55 (2009>)  | X | • | X | • | - | - | - |
| Kona (2018>)  | X | • | X | • | - | - | - |

|  |   |   |   |   |   |   |   |
|--|---|---|---|---|---|---|---|
| Matrix (2008)  | X | • | X | • | - | - | - |
| Pony (2002)  | X | • | X | • | - | - | - |
| Santa Fe (2002)  | X | • | X | • | - | - | - |
| Santa Fe (2007 - 2012)   | X | • | X | • | X | - | X |
| Santa Fe (2012>)   | X | • | X | • | - | - | - |
| Santa Fe (2018>)   | X | • | X | • | - | - | - |
| Tucson (2004>)   | X | • | X | • | - | - | - |
| Tucson (2010>)   | X | • | X | • | - | - | - |
|  Tucson (2015>) | X | • | X | • | - | - | - |
| Tucson (2018>)   | X | • | X | • | - | - | - |
| Veloster (2012>)   | X | • | - | • | - | - | - |
| Verna (2002)   | X | • | X | • | - | - | - |



Infiniti

|                  |   |   |   |   |   |   |   |
|------------------|---|---|---|---|---|---|---|
| EX SUV (2009>)   | X | • | X | • | - | - | - |
| FX SUV (2009>)   | X | • | X | • | - | - | - |
| G70 (2016)       | X | • | X | • | - | - | - |
| G Coupe (2009>)  | X | • | - | • | - | - | - |
| G Saloon (2009>) | X | • | X | • | - | - | - |
| M Saloon (2010>) | X | • | X | • | - | - | - |

Isuzu

|              |   |   |   |   |   |   |   |
|--------------|---|---|---|---|---|---|---|
| D-Max (2007) | X | • | X | • | - | - | - |
|--------------|---|---|---|---|---|---|---|

Jaguar

|  |   |   |   |   |   |   |   |
|--|---|---|---|---|---|---|---|
|  E-Pace (2018>) | X | • | X | • | - | - | - |
| F-Pace (2016>)   | X | • | X | • | - | - | - |
| S-Type (2002)  | X | • | X | • | - | - | - |
| F-Type Coupe (2014>)   | X | - | - | - | - | - | - |
| X-Type (2001 - 2010)   | X | X | X | X | - | - | - |
| X-Type Estate (2004 - 2010)  | X | • | X | • | - | - | - |
|  XE (2015>)     | X | • | X | • | - | - | - |
| XE (2018>)   | X | • | X | • | - | - | - |
| XF (2008>)   | X | • | X | • | - | - | - |
| XF (2009>)   | X | • | X | • | - | - | - |
| XF (2015>)   | X | • | X | • | - | - | - |

|   |                        |   |   |   |   |   |   |   |
|---|------------------------|---|---|---|---|---|---|---|
|  | XF (2018>)             | X | • | X | • | - | - | - |
|   | XF R (2009>)           | X | • | X | • | - | - | - |
|   | XF Sportbrake (2013>)  | X | • | X | • | - | - | - |
|   | XF Sportbrake (2018>)  | X | • | X | • | - | - | - |
|   | XJ (2003)              | X | • | X | • | - | - | - |
|   | XJ (2010>)             | X | • | X | • | - | - | - |
|   | XJ (2018>)             | X | • | X | • | - | - | - |
|   | XK Coupe (2006>)       | X | • | - | • | - | - | - |
|   | XK Convertible (2006>) | X | • | - | • | - | - | - |
|   | XK R (2006>)           | X | • | - | • | - | - | - |

Jeep

|  |                        |   |   |   |   |   |   |   |
|--|------------------------|---|---|---|---|---|---|---|
|  | Cherokee (2014>)       | X | • | X | • | - | - | - |
|  | Compass (2011>)        | X | X | X | X | - | - | - |
|  | Commander (2006)       | X | • | X | • | - | - | - |
|  | Grand Cherokee (2010>) | X | X | X | X | - | - | - |
|  | Grand Patriot (2007)   | X | • | X | • | - | - | - |
|  | Renegade (2015>)       | X | • | X | • | - | - | - |
|  | Wrangler 5dr (2007>)   | X | X | X | X | - | - | - |
|  | Wrangler (2011)        | X | • | X | • | - | - | - |

Kia

|   |                           |   |   |   |   |   |   |   |
|---|---------------------------|---|---|---|---|---|---|---|
|   | Carens (2006)             | X | • | X | • | - | - | - |
|   | <b>SB!</b> Carens (2013>) | X | ! | X | ! | X | - | X |
|   | Carens (2018>)            | X | • | X | • | X | - | X |
|   | Carnival (2006)           | X | • | X | • | • | • | • |
|   | Cee'D (2006)              | X | • | X | • | - | - | - |
|   | Cee'D Hatch (2012>)       | X | • | X | • | - | - | - |
|   | Cee'D Hatch (2018>)       | X | • | X | • | - | - | - |
|   | Magentis (2002-2005)      | X | • | X | • | - | - | - |
|   | Mentor (2002)             | X | • | X | • | - | - | - |
|   | Niro (2018>)              | X | • | X | • | - | - | - |
|  | Opirus (2003)             | X | • | X | • | - | - | - |
|   | Optima (2011 - 2015)      | X | • | X | • | - | - | - |
|   | Optima (2016>)            | X | • | X | • | - | - | - |
|   | Picanto (2008>)           | X | • | X | • | - | - | - |
|   | Picanto (2011>)           | X | • | X | • | - | - | - |

|   |                        |   |   |   |   |   |   |   |
|---|------------------------|---|---|---|---|---|---|---|
|   | Picanto (2018>)        | X | • | X | • | - | - | - |
|   | Rio (2012>)            | X | • | X | • | - | - | - |
|   | Rio (2018>)            | X | • | X | • | - | - | - |
|   | Sephia (2002)          | X | • | X | • | - | - | - |
|   | Shuma (2002)           | X | • | X | • | - | - | - |
|   | Sorento (2010 - 2014)  | X | • | X | • | - | - | - |
|   | Sorento (2015>)        | X | • | X | • | X | - | X |
|  | Soul (2009>)           | X | • | X | • | - | - | - |
|   | Soul EV (2015>)        | X | • | X | • | - | - | - |
|   | Soul (2018>)           | X | • | X | • | - | - | - |
|   | Spectra (2002)         | X | • | X | • | - | - | - |
|   | Sportage (2011 - 2015) | X | • | X | • | - | - | - |
|  | Sportage (2016>)       | X | • | X | • | - | - | - |
|   | Sportage (2018>)       | X | • | X | • | - | - | - |
|   | Stonic (2018>)         | X | • | X | • | - | - | - |
|   | Venga (2009>)          | X | • | X | • | - | - | - |

Lancia

|  |                 |   |   |   |   |   |   |   |
|--|-----------------|---|---|---|---|---|---|---|
|  | Delta (2008>)   | X | • | X | • | - | - | - |
|  | Flavia (2012)   | X | • | X | • | - | - | - |
|  | Musa (2004)     | X | • | X | • | - | - | - |
|  | Phedra (2002)   | X | • | X | • | - | - | - |
|  | Thema (2011>)   | X | • | X | • | - | - | - |
|  | Voyager (2010>) | X | • | - | • | X | X | X |
|  | Ypsilon (2003)  | X | • | X | • | - | - | - |
|  | Ypsilon (2012>) | X | • | X | • | - | - | - |



Land Rover

|  |                                |   |   |   |   |   |   |   |
|--|--------------------------------|---|---|---|---|---|---|---|
|  | Discovery 4 (2009>)            | X | • | X | • | - | - | - |
|  | Discovery 5 (2016)             | X | • | X | • | • | • | • |
|  | Discovery Sport (2015>)        | X | • | X | • | X | - | X |
|  | Discovery Sport (2018>)        | X | • | X | • | X | - | X |
|  | All New Discovery 5 (2018>)    | X | • | X | • | X | - | X |
|  | Freelander 2 (2006>)           | X | • | X | • | - | - | - |
|  | Range Rover (2002 - 2012)      | X | • | X | • | - | - | - |
|  | Range Rover (2013>)            | X | • | X | • | - | - | - |
|  | Range Rover Evoque 3dr (2011>) | X | • | X | • | - | - | - |

① ② ③ ④ ⑤ ⑥ ⑦

|                                 |   |   |   |   |   |   |   |
|---------------------------------|---|---|---|---|---|---|---|
| Range Rover Evoque 5dr (2011>)  | X | • | X | • | - | - | - |
| Range Rover Evoque 3dr (2018>)  | X | • | X | • | - | - | - |
| Range Rover Evoque 5dr (2018>)  | X | • | X | • | - | - | - |
| Range Rover Sport (2005 - 2012) | X | • | X | • | - | - | - |
| Range Rover Sport (2013>)       | X | • | X | • | - | - | - |
| ⚡ Range Rover Sport (2018>)     | X | • | X | • | - | - | - |
| Range Rover Velar (2017)        | X | • | X | • | - | - | - |
| Range Rover Velar (2018>)       | X | • | X | • | - | - | - |
| Range Rover Vogue (2018>)       | X | • | X | • | - | - | - |

Lexus

|  |   |   |   |   |   |   |   |
|--|---|---|---|---|---|---|---|
| CT (2011>)   | X | • | X | • | - | - | - |
| CT (2018>)   | X | • | X | • | - | - | - |
| GS (2000-2013)   | X | • | X | • | - | - | - |
| ⚡ GS (2013>)   | X | • | X | • | - | - | - |
| ⚡ GSh (2013>)  | X | • | X | • | - | - | - |
| IS Saloon (2005 - 2012)  | X | • | X | • | - | - | - |
| IS Saloon (2018>)  | X | • | X | • | - | - | - |
| LS430 (2000)   | X | • | X | • | - | - | - |
| LS 500h (2018>)  | X | • | X | • | - | - | - |
|  NX (2014>)       | X | • | X | • | - | - | - |
|  NX Sport (2018>) | X | • | X | • | - | - | - |
| RC 3dr (2018>)   | X | • | X | • | - | - | - |
| RX300/RX400 (2006)   | X | • | X | • | - | - | - |
| ⚡ RX450h (2009)  | X | • | X | • | - | - | - |
| RX (2010>)   | X | • | X | • | - | - | - |
| RX (2018>)   | X | • | X | • | - | - | - |
| RXL (2018>)  | X | • | X | • | - | - | - |

Maserati



|                     |   |   |   |   |   |   |   |
|---------------------|---|---|---|---|---|---|---|
| Quattroporte (2008) | X | • | X | • | - | - | - |
| Gran Turismo (2008) | X | • | X | • | - | - | - |

Maybach

|                  |   |   |   |   |   |   |   |
|------------------|---|---|---|---|---|---|---|
| W240/V240 (2002) | X | • | X | • | - | - | - |
|------------------|---|---|---|---|---|---|---|

① ② ③ ④ ⑤ ⑥ ⑦

Mazda

|  |   |   |   |   |   |   |   |
|--|---|---|---|---|---|---|---|
|  2 (2015>)        | X | • | X | • | - | - | - |
|  2 (2007 - 2015)  | X | • | X | • | - | - | - |
| 3 Hatchback (2014>)  | X | • | X | • | - | - | - |
| 3 Hatchback (2009 - 2013)  | X | • | X | • | - | - | - |
| 3 Saloon (2009 - 2013)   | X | • | X | • | - | - | - |
| 323 (2001)   | X | • | X | • | - | - | - |
| 5 (2005 - 2010)  | X | • | X | • | - | - | - |
| 6 Estate (2012>)   | X | • | X | • | - | - | - |
| 6 Hatch (2007 - 2012)  | X | • | X | • | - | - | - |
| 6 Saloon (2007 - 2009)   | X | • | X | • | - | - | - |
| 6 Saloon (2012>)   | X | • | X | • | - | - | - |
| 6 Saloon (2018>)   | X | • | X | • | - | - | - |
| 6 (2002-2008)  | X | • | X | • | - | - | - |
| 6 Estate (2008 - 2012)   | X | • | X | • | - | - | - |
| 6 Estate (2012>)   | X | • | X | • | - | - | - |
|  6 Estate (2018>) | X | • | X | • | - | - | - |
| CX-3 (2015>)   | X | • | X | • | - | - | - |
| CX-5 (2011>)   | X | • | X | • | - | - | - |
| CX-5 (2018>)   | X | • | X | • | - | - | - |
| CX-7 (2007 - 2011)   | X | • | X | • | - | - | - |
| Demio (2007)   | X | • | X | • | - | - | - |
| MPV (2002)   | X | • | X | • | - | - | - |
| Premacy (2001)   | X | • | X | • | - | - | - |
| MX-5 (1998-2005)   | X | - | - | - | - | - | - |
| MX-5 (2015>)   | X | - | - | - | - | - | - |
| RX-8 (2003)  | X | • | X | • | - | - | - |
| Tribute (2001)   | X | • | X | • | - | - | - |
| Verisa (2004)  | X | • | X | • | - | - | - |

Mercedes-Benz

|                       |   |   |   |   |   |   |   |
|-----------------------|---|---|---|---|---|---|---|
| A Class (2001 - 2005) | X | • | X | • | - | - | - |
| A Class (2005 - 2012) | X | • | X | • | - | - | - |
| A-Class (2013>)       | X | • | X | • | - | - | - |
| ⚡ B-Class (2011>)     | X | • | X | • | - | - | - |
| ⚡ B-Class EV (2015>)  | X | • | X | • | - | - | - |
| C-Class (2000)        | X | • | X | • | - | - | - |
| C-Class (2008>)       | X | • | X | • | - | - | - |
| C-Class Coupe (2011>) | X | • | - | • | - | - | - |

|                              |   |   |   |   |   |   |   |
|------------------------------|---|---|---|---|---|---|---|
| C-Class Estate (2008>)       | X | • | X | • | - | - | - |
| C-Class Estate (2015>)       | X | • | X | • | - | - | - |
| Citan (2012)                 | X | • | X | • | - | - | - |
| CLA (2013>)                  | X | • | X | • | - | - | - |
| CLC (2008)                   | X | • | X | • | - | - | - |
| CLK (2002-2010)              | X | • | X | • | - | - | - |
| CLS Coupe (2004)             | X | • | X | • | - | - | - |
| CLS Coupe (2011>)            | X | • | X | • | - | - | - |
| CLS Coupe (2018>)            | X | • | X | • | - | - | - |
| CLS Shooting Brake (2012>)   | X | • | X | • | - | - | - |
| E-Class Coupe (2009>)        | X | • | - | • | - | - | - |
| E-Class (2002)               | X | • | X | • | - | - | - |
| E-Class (2006 - 2009)        | X | • | X | • | - | - | - |
| E-Class (2018>)              | X | • | X | • | - | - | - |
| E-Class Saloon (2009 - 2012) | X | • | X | • | - | - | - |
| E-Class Saloon (2013>)       | X | • | X | • | - | - | - |
| E-Class Estate (2009>)       | X | • | X | • | - | - | - |
| E-Class Estate (2013>)       | X | • | X | • | - | - | - |
| GL Class (2006 - 2012)       | X | • | X | • | X | - | X |
| GL Class (2012>)             | X | • | X | • | X | - | X |
| GLA (2014>)                  | X | • | X | • | - | - | - |
| GLA (2018>)                  | X | • | X | • | - | - | - |
| GLC SUV (2018>)              | X | • | X | • | - | - | - |
| GLE (2015>)                  | X | • | X | • | - | - | - |
| GLE SUV (2018>)              | X | • | X | • | - | - | - |
| GLK (2012)                   | X | • | X | • | - | - | - |
| GLS (2018>)                  | X | • | X | • | • | - | • |
| M (2011)                     | X | • | X | • | - | - | - |
| ML-Class (2005 - 2012)       | X | • | X | • | - | - | - |
| ML-Class (2012>)             | X | • | X | • | - | - | - |
| M-Klasse (1997-2005)         | X | • | X | • | - | - | - |
| R-Class (2005 - 2012)        | X | • | X | • | - | - | - |
| S Class (2015>)              | X | • | X | • | - | - | - |
| S Class (2006 - 2013)        | X | • | X | • | - | - | - |
| SL Class (2011>)             | X | - | - | - | - | - | - |
| SLK (2011>)                  | X | - | - | - | - | - | - |
| S-Class (2005 - 2015)        | X | • | X | • | - | - | - |
| Sprinter (2006)              | X | • | X | • | - | - | - |
| V-Class (2014>)              | X | • | • | • | • | X | • |

**MG**



|                          |   |   |   |   |   |   |   |
|--------------------------|---|---|---|---|---|---|---|
| V-Class (2018>)          | X | • | • | • | X | • | • |
| Vaneo (2001-2005)        | X | • | • | • | • | - | - |
| Viano (2003-2010)        | X | • | X | • | • | - | • |
| Vito (2010)              | X | • | • | X | • | • | - |
| 25 (1999 - 2005)         | X | X | X | X | - | - | - |
| GS (2016>)               | X | • | X | • | - | - | - |
| 3 (2013 - 2015)          | X | • | X | • | - | - | - |
| 3 (2016>)                | X | • | X | • | - | - | - |
| Streetwise (1999 - 2005) | X | X | X | X | - | - | - |
| ZR (2001 - 2005)         | X | X | X | X | - | - | - |
| ZT (2003 - 2006)         | X | X | X | X | - | - | - |

**MINI**



|                         |   |   |   |   |   |   |   |
|-------------------------|---|---|---|---|---|---|---|
| Countryman (2010>)      | X | • | X | • | - | - | - |
| Countryman 4 (2010>)    | X | • | X | • | - | - | - |
| Countryman 5 (2010>)    | X | • | X | • | - | - | - |
| R56 (2010>)             | X | • | X | • | - | - | - |
| R57 (2009>)             | X | • | X | • | - | - | - |
| Hatchback (2006 - 2014) | X | • | - | - | - | - | - |
| Hatchback (2014>)       | X | • | - | • | - | - | - |
| Cooper S (2006>)        | X | • | - | - | - | - | - |
| Coupe (2009>)           | X | - | - | - | - | - | - |
| Coupe (2014>)           | X | X | X | X | - | - | - |
| Hatchback 3Dr (2014>)   | X | • | - | • | - | - | - |
| Hatchback 5dr (2015>)   | X | • | X | • | - | - | - |
| Paceman (2013>)         | X | • | - | - | - | - | - |
| 5dr (2015>)             | X | • | X | • | - | - | - |

**Mitsubishi**

|                      |   |   |   |   |   |   |   |
|----------------------|---|---|---|---|---|---|---|
| ASX (2010>)          | X | • | X | • | - | - | - |
| Colt (2004 - 2008)   | X | • | X | • | - | - | - |
| Colt (2007 - 2013)   | X | • | X | • | - | - | - |
| Grandis (2004-2011)  | X | • | X | • | - | - | - |
| Lancer (2007 - 2011) | X | • | - | • | - | - | - |

|  |   |   |   |   |   |   |   |
|--|---|---|---|---|---|---|---|
| Lancer Evo (2004)  | ✗ | • | - | • | - | - | - |
| Lancer Ralliart (2009 - 2011)  | ✗ | • | - | • | - | - | - |
| Lancer Sportback (2008 - 2012)   | ✗ | • | - | • | - | - | - |
| Mirage (2014>)   | ✗ | ✗ | • | - | - | - | - |
| Mirage 5dr (2016)  | ✗ | ✗ | ✗ | • | - | - | - |
| Outlander (2003)   | ✗ | • | ✗ | • | - | - | - |
| Outlander (2006 - 2013)  | ✗ | • | ✗ | • | - | - | - |
| Outlander (2013>)  | ✗ | • | ✗ | • | - | - | - |
|  Outlander PHEV (2015>) | ✗ | • | ✗ | • | - | - | - |
| Pajero (2007)  | ✗ | • | ✗ | • | - | - | - |
| Shogun (2007>)   | ✗ | • | ✗ | • | - | - | - |

Nissan

|   |   |   |   |   |   |   |   |
|---|---|---|---|---|---|---|---|
| Almera (2000)   | ✗ | • | ✗ | • | - | - | - |
| Juke (2010>)  | ✗ | • | ✗ | • | - | - | - |
| Juke (2018>)  | ✗ | • | ✗ | • | - | - | - |
|  Leaf EV (2011>)     | ✗ | • | ✗ | • | - | - | - |
|  New Leaf EV (2018>) | ✗ | • | ✗ | • | - | - | - |
| Maxima (1999)   | ✗ | • | ✗ | • | - | - | - |
| Micra (2000)  | ✗ | • | ✗ | • | - | - | - |
| Micra (2011>)   | ✗ | • | ✗ | • | - | - | - |
| Micra (2018>)   | ✗ | • | ✗ | • | - | - | - |
| Murano (2003)   | ✗ | • | ✗ | • | - | - | - |
| Murano (2016>)  | ✗ | • | ✗ | • | - | - | - |
| Navara (2005)   | ✗ | • | ✗ | • | - | - | - |
| Note (2004 - 2013)  | ✗ | • | ✗ | • | - | - | - |
| Note (2014>)  | ✗ | • | ✗ | • | - | - | - |
| Pathfinder (2007)   | ✗ | • | ✗ | • | - | - | - |
| Pixo (2009)   | ✗ | • | ✗ | • | - | - | - |
| Primera (1996-2002)   | ✗ | • | ✗ | • | - | - | - |
| Pulsar (2015>)  | ✗ | • | ✗ | • | - | - | - |
| Qashqai +2 (2008 - 2015)  | ✗ | • | ✗ | • | - | - | - |
| Qashqai (2007 - 2013)   | ✗ | • | ✗ | • | - | - | - |
| Qashqai (2014>)   | ✗ | • | ✗ | • | - | - | - |
| Qashqai (2018>)   | ✗ | • | ✗ | • | - | - | - |
| Quest MPV (2012>)   | ✗ | • | - | • | ✗ | - | ✗ |
| Tiida (2004)  | ✗ | • | ✗ | • | - | - | - |
| 2008 X-Trail (2001)   | ✗ | • | ✗ | • | - | - | - |

|                            |   |   |   |   |   |   |   |
|----------------------------|---|---|---|---|---|---|---|
| 2008 X-Trail (2007 - 2015) | ✗ | • | ✗ | • | - | - | - |
| X-Trail (2015>)            | ✗ | • | ✗ | • | ✗ | - | ✗ |
| X-Trail (2018>)            | ✗ | • | ✗ | • | ✗ | - | ✗ |

Opel

|   |   |   |   |   |   |   |   |
|---|---|---|---|---|---|---|---|
| Adam (2013>)  | ✗ | • | - | • | - | - | - |
| Agila (2002)  | ✗ | • | ✗ | • | - | - | - |
| Agila (2008>)   | ✗ | • | ✗ | • | - | - | - |
|  Ampera (2011>)  | ✗ | • | - | • | - | - | - |
| Antara (2006 - 2015)  | ✗ | • | ✗ | • | - | - | - |
| Astra (2004 - 2010)   | ✗ | • | ✗ | • | - | - | - |
| Astra 5dr (2010>)   | ✗ | • | ✗ | • | - | - | - |
| Astra (2015>)   | ✗ | • | ✗ | • | - | - | - |
| Astra Estate (2010>)  | ✗ | • | ✗ | • | - | - | - |
| Astra GTC (2011>)   | ✗ | • | ✗ | • | - | - | - |
| Caravan (2004)  | ✗ | • | ✗ | • | - | - | - |
| Combo (2001)  | ✗ | • | ✗ | • | - | - | - |
| Corsa 3 dr Hatch (2006 - 2015)  | ✗ | • | ✗ | • | - | - | - |
| Corsa 5 dr Hatch (2006 - 2015)  | ✗ | • | ✗ | • | - | - | - |
| Corsa 5dr (2015>)   | ✗ | • | ✗ | • | - | - | - |
|  Corsa C (2000)  | ✗ | • | ✗ | • | - | - | - |
|  Corsa D (2006>) | ✗ | • | ✗ | • | - | - | - |
| Corsa VXR (2007>)   | ✗ | • | ✗ | • | - | - | - |
| Insignia Hatch (2008>)  | ✗ | • | ✗ | • | - | - | - |
| Insignia Saloon (2009>)   | ✗ | • | ✗ | • | - | - | - |
| Insignia Sports Tourer (2009>)  | ✗ | • | ✗ | • | - | - | - |
| Karl (2015>)  | ✗ | • | ✗ | • | - | - | - |
| Meriva (2002)   | ✗ | • | ✗ | • | - | - | - |
| Meriva (2010>)  | ✗ | • | ✗ | • | - | - | - |
| Mokka (2012>)   | ✗ | • | ✗ | • | - | - | - |
| Signum (2003-2008)  | ✗ | • | ✗ | • | - | - | - |
| Vectra (2002 - 2008)  | ✗ | • | ✗ | • | - | - | - |
| Vivaro (2001)   | ✗ | • | ✗ | • | - | - | - |
| Zafira (2005 - 2014)  | ✗ | • | ✗ | • | - | - | - |
| Zafira Tourer (2012>)   | ✗ | • | ✗ | • | ✗ | - | ✗ |
| Zafira VXR (2005>)  | ✗ | • | ✗ | • | - | - | - |

Peugeot





|  |   |   |   |   |   |   |   |
|--|---|---|---|---|---|---|---|
| 107 (2005 - 2014)  | X | • | - | • | - | - | - |
| 108 (2014)   | X | • | X | • | - | - | - |
| 108 (2015>)  | X | • | - | • | - | - | - |
| 108 (2018>)  | X | • | - | • | - | - | - |
| 206 (1998)   | X | • | X | • | - | - | - |
| 206 3dr (2004 - 2009)  | X | • | X | • | - | - | - |
| 207 3dr (2006 - 2012)  | X | • | X | • | - | - | - |
| 207 5dr (2006 - 2012)  | X | • | X | • | - | - | - |
| 207 SW (2007 - 2012)   | X | • | X | • | - | - | - |
| 208 3dr (2012>)  | X | • | X | • | - | - | - |
| 208 5dr (2012>)  | X | • | X | • | - | - | - |
| 208 3dr (2018>)  | X | • | X | • | - | - | - |
| 208 5dr (2018>)  | X | • | X | • | - | - | - |
| 307 (2001 - 2008)  | X | • | X | • | - | - | - |
| 307 Estate (2002 - 2007)   | X | • | X | • | - | - | - |
| 308 (2018>)  | X | • | X | • | - | - | - |
| 308 (2014>)  | X | • | X | • | - | - | - |
| 308 Hatch (2007 - 2014)  | X | • | X | • | - | - | - |
| 308 SW (2008 - 2015)   | X | • | X | • | - | - | - |
| 308 SW (2014>)   | X | • | X | • | - | - | - |
|  406 (2000) | X | • | X | • | - | - | - |
| 407 (2004 - 2011)  | X | • | X | • | - | - | - |
| 407 SW (2004 - 2011)   | X | X | X | X | - | - | - |
| 508 (2011>)  | X | • | X | • | - | - | - |
| 607 (2000)   | X | • | X | • | - | - | - |
| <b>SBI</b> 807 (2002-2010)   | X | ! | X | ! | • | - | • |
| 1007 (2005)  | X | • | X | • | - | - | - |
| 2008 (2013>)   | X | • | X | • | - | - | - |
| 2008 (2018>)   | X | • | X | • | - | - | - |
| <b>SBI</b> 3008 (2009 - 2016)  | X | ! | X | • | - | - | - |
| 3008 (2017>)   | X | • | X | • | - | - | - |
| 3008 (2018>)   | X | • | X | • | - | - | - |
| 4007 (2007 - 2012)   | X | • | X | • | - | - | - |
| 4008 (2011>)   | X | • | X | • | - | - | - |
| 5008 (2009>)   | X | • | • | • | X | - | X |
| <b>SBI</b> 5008 (2010>)  | X | ! | X | ! | X | X | X |
| 207 SW (2007 - 2012)   | X | • | X | • | - | - | - |
| 208 5DR (2013>)  | X | • | X | • | - | - | - |
| 308 SW (2008 - 2015)   | X | • | X | • | - | - | - |

|                             |   |   |   |   |   |   |   |
|-----------------------------|---|---|---|---|---|---|---|
| 308 SW (2015>)              | X | • | X | • | - | - | - |
| 508 RXH (2013>)             | X | • | X | • | - | - | - |
| 508 SW (2011>)              | X | • | X | • | - | - | - |
| Bipper (2008>)              | X | • | X | • | - | - | - |
| Expert Tepee (2007 - 2016)  | X | • | X | • | X | X | X |
| Partner Combi (2004 - 2010) | X | X | X | X | - | - | - |
| Partner Tepee (2008>)       | X | • | X | • | - | - | - |
| RCZ (2011)                  | X | • | - | X | - | - | - |
| Traveller (2016>)           | X | • | • | • | • | • | • |
| Traveller (2018>)           | X | • | • | • | • | • | • |

Pontiac

|                  |   |   |   |   |   |   |   |
|------------------|---|---|---|---|---|---|---|
| Pontiac Grand AM | X | • | X | • | - | - | - |
|------------------|---|---|---|---|---|---|---|

Porsche

|  |   |   |   |   |   |   |   |
|--|---|---|---|---|---|---|---|
| Cayenne (2003)   | X | • | X | • | - | - | - |
| Cayenne (2011>)  | X | • | X | • | - | - | - |
|  Cayenne E-Hybrid (2015>)  | X | • | X | • | - | - | - |
|  Cayenne E-Hybrid (2018>)  | X | • | X | • | - | - | - |
| Macan (2014)   | X | • | X | • | - | - | - |
| Macan Turbo (2018>)  | X | • | X | • | - | - | - |
| Panamera (2009>)   | X | • | - | • | - | - | - |
| Panamera (2011>)   | X | • | - | • | - | - | - |
|  Panamera E-Hybrid (2015>) | X | • | - | • | - | - | - |
|  Panamera E-Hybrid (2018>) | X | • | - | • | - | - | - |
| Panamera Estate (2018>)  | X | • | X | • | - | - | - |

Renault

|                                 |   |   |   |   |   |   |   |
|---------------------------------|---|---|---|---|---|---|---|
| Avantime (2001)                 | X | • | X | • | - | - | - |
| Captur (2013>)                  | X | • | X | • | - | - | - |
| Captur (2018>)                  | X | • | X | • | - | - | - |
| Clio Sport (2006 - 2012)        | X | • | X | • | - | - | - |
| Clio Sport (2013>)              | X | X | X | X | - | - | - |
| Clio Sport 5dr (2017>)          | X | • | X | • | - | - | - |
| Clio Sport Tourer (2007 - 2012) | X | • | X | • | - | - | - |
| Clio Sport Tourer (2013>)       | X | • | X | • | - | - | - |

|   |   |   |   |   |   |   |   |
|---|---|---|---|---|---|---|---|
| Clio (1998 - 2003)  | X | • | X | • | - | - | - |
| Clio (2005 - 2012)  | X | • | X | • | - | - | - |
| Clio (2013>)  | X | • | X | • | - | - | - |
| Clio (2018>)  | X | • | X | • | - | - | - |
| Espace (2003 - 2012)  | X | • | • | • | • | • | • |
| Fluence (2010)  | X | • | X | • | - | - | - |
| Grand Espace (2000)   | X | • | • | • | • | • | • |
| Grand Espace (2002 - 2012)  | X | • | • | • | • | • | • |
| Grand Modus (2008 - 2012)   | X | • | X | • | - | - | - |
| Grand Scenic (2009)   | X | X | • | X | - | - | - |
| Kangoo (1999)   | X | X | X | • | - | - | - |
| Kangoo (2008-2013)  | X | • | X | • | - | - | - |
| Kadjar (2015>)  | X | • | X | • | - | - | - |
| Kadjar (2018>)  | X | • | X | • | - | - | - |
| Koleos (2018>)  | X | • | X | • | - | - | - |
| Laguna (2001)   | X | • | X | • | - | - | - |
| Laguna (2008 - 2012)  | X | • | X | • | - | - | - |
| Laguna GrandTour (2010)   | X | • | X | • | - | - | - |
| Laguna Sport Tourer (2008 - 2012)   | X | • | X | • | - | - | - |
| Megane (1999)   | X | • | X | • | - | - | - |
| Megane (2007)   | X | • | X | • | - | - | - |
| Megane Coupe (2003)   | X | • | X | • | - | - | - |
| Megane Grand Tour (1999-2003)   | X | • | X | • | - | - | - |
| Megane Grand Tour (2009)  | X | • | X | • | - | - | - |
| Megane Hatch (2002 - 2009)  | X | • | X | • | - | - | - |
| SB! Megane Hatch (2008>)  | X | ! | X | ! | - | - | - |
| Megane Hatch (2016>)  | X | • | X | • | - | - | - |
| Megane Scenic (2003)  | X | • | X | • | - | - | - |
| Megane Sport Tourer (2009>)   | X | • | X | • | - | - | - |
|  Megane Sport Tourer (2018>) | X | • | X | • | - | - | - |
| Modus (2004 - 2012)   | X | • | X | • | - | - | - |
| Grand Modus (2008 - 2012)   | X | • | X | • | - | - | - |
| Sandero (2012)  | X | • | X | • | - | - | - |
| Scenic/Grand Scenic (1999)  | X | • | X | • | - | - | - |
| Scenic (2002 - 2009)  | X | • | X | • | - | - | - |
| SB! Scenic (2009 - 2016)  | X | ! | X | ! | - | - | - |
| Scenic (2018>)  | X | • | X | • | - | - | - |
| Trafic (2001-2007)  | X | X | • | X | • | - | - |
| Trafic (2010)   | X | • | • | X | - | - | - |

|  |   |   |   |   |   |   |   |
|--|---|---|---|---|---|---|---|
|  Twingo (1998 - 2007) | X | • | X | • | - | - | - |
| Twingo (2007 - 2014)   | X | • | - | • | - | - | - |
| Twingo (2015>)   | X | • | - | • | - | - | - |
| Twingo (2018>)   | X | • | - | • | - | - | - |
| Vel Satis (2002)   | X | • | X | • | - | - | - |
|  Zoe (2012)           | X | • | X | • | - | - | - |

SAAB

|                               |   |   |   |   |   |   |   |
|-------------------------------|---|---|---|---|---|---|---|
| 9-3 (2002 - 2012)             | X | • | X | • | - | - | - |
| 9-3 Sport Wagon (2005 - 2012) | X | • | X | • | - | - | - |
| 9-3 X (2009 - 2012)           | X | • | X | • | - | - | - |
| 9-5 (2011 - 2012)             | X | • | X | • | - | - | - |
| 9-5 Estate (2005 - 2010)      | X | • | X | • | - | - | - |

SEAT

|                                    |   |   |   |   |   |   |   |
|------------------------------------|---|---|---|---|---|---|---|
| Alhambra (1995 - 2010)             | X | • | • | • | • | - | - |
| SB! Alhambra (2010>)               | X | ! | X | ! | - | - | - |
| Altea (2004 - 2011)                | X | • | X | • | - | - | - |
| Altea Freetrack4 (2007 - 2009)     | X | • | X | • | - | - | - |
| Altea XL (2006 - 2011)             | X | • | X | • | - | - | - |
| Arona (2018>)                      | X | • | X | • | - | - | - |
| Arosa (1997 - 2004)                | X | • | X | • | - | - | - |
| Ateca Estate (2018>)               | X | • | X | • | - | - | - |
| Cordoba Vario (1996 - 2002)        | X | • | - | - | - | - | - |
| Exeo (2008 - 2014)                 | X | • | X | • | - | - | - |
| Exeo ST Estate (2008 - 2014)       | X | • | X | • | - | - | - |
| Ibiza (1993 - 2002)                | X | • | X | • | - | - | - |
| Ibiza (2002 - 2008)                | X | • | X | • | - | - | - |
| Ibiza Cupra (2009>)                | X | • | X | • | - | - | - |
| Ibiza FR (2009>)                   | X | • | X | • | - | - | - |
| Ibiza Hatch (2008 - 2013)          | X | • | X | • | - | - | - |
| Ibiza Hatch (2018>)                | X | • | X | • | - | - | - |
| Inca (2000)                        | X | • | X | • | - | - | - |
| Leon Cupra (2007 - 2011)           | X | • | X | • | - | - | - |
| Leon Cupra Special Edition (2018>) | X | • | X | • | - | - | - |
| Leon FR (2006 - 2012)              | X | • | X | • | - | - | - |
| Leon Hatch (2005 - 2015)           | X | • | X | • | - | - | - |

|                           |   |   |   |   |   |   |   |
|---------------------------|---|---|---|---|---|---|---|
| Leon (1998)               | X | • | X | • | - | - | - |
| Leon (2013>)              | X | • | X | • | - | - | - |
| Leon (2018>)              | X | • | X | • | - | - | - |
| Leon Sport Tourer (2018>) | X | • | X | • | - | - | - |
| Mii (2011>)               | X | • | X | • | - | - | - |
| Mii 3dr (2014>)           | X | • | X | • | - | - | - |
| Mii 5dr (2016>)           | X | • | X | • | - | - | - |
| Mii 3dr (2018>)           | X | • | X | • | - | - | - |
| Mii 5dr (2018>)           | X | • | X | • | - | - | - |
| Toledo (1994 - 2004)      | X | • | X | • | - | - | - |
| Toledo (2013>)            | X | • | X | • | - | - | - |
| Toledo (2018>)            | X | • | X | • | - | - | - |

**Skoda**

|  |   |   |   |   |   |   |   |
|--|---|---|---|---|---|---|---|
| Citigo (2011>)   | X | • | X | • | - | - | - |
| Citigo 3dr (2018>)   | X | • | X | • | - | - | - |
| Citigo 5dr (2018>)   | X | • | X | • | - | - | - |
| Fabia (1999 - 2007)  | X | • | X | • | - | - | - |
| Fabia (2015>)  | X | • | X | • | - | - | - |
| Fabia (2018>)  | X | • | X | • | - | - | - |
| Fabia Hatch (2007>)  | X | • | X | • | - | - | - |
| Fabia Estate Combi (2008>)   | X | • | X | • | - | - | - |
| Karoq (2018>)  | X | • | X | • | - | - | - |
| Kodiaq (2018>)   | X | • | X | • | - | - | - |
| Octavia (1996 - 2004)  | X | • | X | • | - | - | - |
| Octavia Hatch (2004 - 2012)  | X | • | X | • | - | - | - |
| Octavia Hatch (2013>)  | X | • | X | • | - | - | - |
| Octavia Hatch (2018>)  | X | • | X | • | - | - | - |
| Octavia Estate Combi (2005 - 2013)   | X | • | X | • | - | - | - |
| Octavia Estate (2018>)   | X | • | X | • | - | - | - |
| Octavia Scout (2007 - 2013)  | X | • | X | • | - | - | - |
| Rapid (2013>)  | X | • | X | • | - | - | - |
| Rapid (2018>)  | X | • | X | • | - | - | - |
| Roomster (2006>)   | X | • | X | • | - | - | - |
| Superb (2001 - 2008)   | X | • | X | • | - | - | - |
| Superb (2008 - 2014)   | X | • | X | • | - | - | - |
| Superb (2015>)   | X | • | X | • | - | - | - |
|  Superb Hatch (2018>) | X | • | X | • | - | - | - |

|                             |   |   |   |   |   |   |   |
|-----------------------------|---|---|---|---|---|---|---|
| Superb Combi/Estate (2008>) | X | • | X | • | - | - | - |
| Superb Estate (2018>)       | X | • | X | • | - | - | - |
| Yeti (2009>)                | X | • | X | • | - | - | - |

**Smart**

|                             |   |   |   |   |   |   |   |
|-----------------------------|---|---|---|---|---|---|---|
| For Two Coupe (2007 - 2011) | X | - | - | - | - | - | - |
| For Two Coupe (2018>)       | X | - | - | - | - | - | - |
| FourFour (2004 - 2006)      | X | • | X | • | - | - | - |
| FourFour (2015>)            | X | • | X | • | - | - | - |
| FourFour (2018>)            | X | • | X | • | - | - | - |

**Ssangyong**

|                      |   |   |   |   |   |   |   |
|----------------------|---|---|---|---|---|---|---|
| Actyon (2006 - 2011) | X | • | X | • | - | - | - |
| Korando (2011>)      | X | • | X | • | - | - | - |
| Kyron (2005 - 2011)  | X | • | X | • | - | - | - |
| Musso Pickup (2016>) | X | • | X | • | - | - | - |
| Rexton (2014>)       | X | • | X | • | - | - | - |
| Tivoli (2016>)       | X | • | X | • | - | - | - |
| Turismo (2014>)      | X | • | - | • | X | X | X |

**Subaru**

|                           |   |   |   |   |   |   |   |
|---------------------------|---|---|---|---|---|---|---|
| BRZ (2012>)               | X | • | - | • | - | - | - |
| Forester (2003 - 2008)    | X | • | X | • | - | - | - |
| Forester (2013>)          | X | • | X | • | - | - | - |
| Impreza 5dr (2007 - 2012) | X | • | X | • | - | - | - |
| Impreza 5dr (2013>)       | X | • | X | • | - | - | - |
| Justy (2004)              | X | • | X | • | - | - | - |
| Legacy (2012>)            | X | • | X | • | - | - | - |
| Legacy (2004)             | X | • | X | • | - | - | - |
| Outback (2012>)           | X | • | X | • | - | - | - |
| Sedan (2002- 2004)        | X | • | X | • | - | - | - |
| Wagon (2002- 2004)        | X | • | X | • | - | - | - |
| XV Hatchback (2011>)      | X | • | X | • | - | - | - |



Suzuki

|   |                      |   |   |   |   |   |   |   |
|---|----------------------|---|---|---|---|---|---|---|
|  | Alto (2009>)         | X | • | X | • | - | - | - |
|   | Baleno (2016>)       | X | • | X | • | - | - | - |
|   | Grand Vitara (2002>) | X | • | X | • | - | - | - |
|   | Grand Vitara (2005>) | X | • | X | • | - | - | - |
|   | Ignis (2004)         | X | • | X | • | - | - | - |
|   | Kizashi (2010)       | X | • | X | • | - | - | - |
|   | Liana (2002)         | X | • | X | • | - | - | - |
|   | Splash (2007>)       | X | • | X | • | - | - | - |
|   | Swift (2004)         | X | • | X | • | - | - | - |
|   | Swift Sport (2011>)  | X | • | X | • | - | - | - |
|   | SX-4 (2006>)         | X | • | X | • | - | - | - |
|   | SX-4 Saloon (2009>)  | X | • | X | • | - | - | - |
|   | Vitara (2015>)       | X | • | X | • | - | - | - |
|   | Wagon R+ (2002)      | X | • | X | • | - | - | - |

TATA







|  |                     |   |   |   |   |   |   |   |
|--|---------------------|---|---|---|---|---|---|---|
|  | Indica Vista (2008) | X | • | X | • | - | - | - |
|--|---------------------|---|---|---|---|---|---|---|

Tesla

|   |                 |   |   |   |   |   |   |   |
|---|-----------------|---|---|---|---|---|---|---|
|  | Model S (2014>) | X | • | X | • | - | - | - |
|  | Model X (2016>) | X | • | X | • | • | X | • |



Toyota

|  |                             |   |   |   |   |   |   |   |
|--|-----------------------------|---|---|---|---|---|---|---|
|  | Auris (2007- 2012)          | X | • | X | • | - | - | - |
|  | Auris (2013>)               | X | • | X | • | - | - | - |
|  | Avensis Hatch (2003 - 2011) | X | • | X | • | - | - | - |
|  | Avensis Tourer (2009>)      | X | • | X | • | - | - | - |
|  | Aygo (2018>)                | X | • | - | • | - | - | - |
|  | Aygo (2014>)                | X | • | - | - | - | - | - |
|  | Aygo 3dr (2005 - 2014)      | X | • | - | • | - | - | - |
|  | Camry (2001)                | X | • | X | • | - | - | - |
|  | Corolla (2002 - 2007)       | X | • | X | • | - | - | - |
|  | C-HR (2017>)                | X | • | X | • | - | - | - |
|  | EZ MPV (2013>)              | X | • | X | • | - | - | - |
|  | GT86 (2012>)                | X | • | - | • | - | - | - |
|  | GT86 (2018>)                | X | • | - | • | - | - | - |







|  |   |   |   |   |   |   |   |   |
|--|---|---|---|---|---|---|---|---|
|  | Highlander (2013>)  | X | • | X | • | - | - | - |
|  | IQ (2009)   | X | • | X | • | - | - | - |
|  | Landcruiser (2002 - 2009)   | X | • | X | • | - | - | - |
|  | Landcruiser (2009>)   | X | • | X | • | - | - | - |
|  | Landcruiser (2018>)   | X | • | X | • | - | - | - |
|  | Previa (2000 - 2009)  | X | • | X | • | - | - | - |
|  |  Prius (2010>)         | X | • | X | • | - | - | - |
|  |  Prius (2018>)         | X | • | X | • | - | - | - |
|  |  Prius 2 (2004 - 2010) | X | • | X | • | - | - | - |
|  |  Prius 3 (2010 - 2016) | X | • | X | • | - | - | - |
|  |  Prius 4 (2016>)       | X | • | X | • | - | - | - |
|  |  Prius Plus+ (2012>)   | X | • | X | • | - | - | - |
|  |  Prius PHEV 3 (2015>)  | X | • | X | • | - | - | - |
|  | RAV4 (2000 - 2006)  | X | • | X | • | - | - | - |
|  | RAV4 (2013>)  | X | • | X | • | - | - | - |
|  | RAV4 (2018>)  | X | • | X | • | - | - | - |
|  | RAV4 MK3 (2006 - 2011)  | X | • | X | • | - | - | - |
|  | Urban Cruiser (2009)  | X | • | X | • | - | - | - |
|  | <b>SB!</b> Verso (2009 - 2012)  | X | ! | X | ! | - | - | - |
|  | Verso (2012>)   | X | • | X | • | X | • | - |
|  | Yaris (1999 - 2005)   | X | • | X | • | - | - | - |
|  | Yaris (2008 - 2011)   | X | • | X | • | - | - | - |
|  | Yaris Hatch (2011>)   | X | • | X | • | - | - | - |
|  | Yaris Hatch (2018>)   | X | • | X | • | - | - | - |





Vauxhall



|  |  |   |   |   |   |   |   |   |
|--|--|---|---|---|---|---|---|---|
|  | Adam (2013>)   | X | • | - | • | - | - | - |
|  | Agila (2002)   | X | • | X | • | - | - | - |
|  |  Agila (2008>)  | X | • | X | • | - | - | - |
|  |  Ampera (2011>) | X | • | - | • | - | - | - |
|  | Antara (2006 - 2015)   | X | • | X | • | - | - | - |
|  | Astra (2004 - 2010)  | X | • | X | • | - | - | - |
|  | Astra (2015>)  | X | • | X | • | - | - | - |
|  | Astra 5 dr (2010>)   | X | • | X | • | - | - | - |
|  | Astra Estate (2010>)   | X | • | X | • | - | - | - |
|  | Astra 5dr Sport Tourer (2018>)   | X | • | X | • | - | - | - |
|  | Astra GTC (2011>)  | X | • | X | • | - | - | - |
|  | Caravan (2004)   | X | • | X | • | - | - | - |

|  |   |   |   |   |   |   |   |
|--|---|---|---|---|---|---|---|
| Combo (2001)   | ✗ | • | ✗ | • | - | - | - |
| Corsa 3dr Hatch (2006 - 2015)  | ✗ | • | ✗ | • | - | - | - |
| Corsa 5dr Hatch (2006 - 2015)  | ✗ | • | ✗ | • | - | - | - |
| Corsa 5dr (2015>)  | ✗ | • | ✗ | • | - | - | - |
| Corsa 3dr (2018>)  | ✗ | • | ✗ | • | - | - | - |
| Corsa 5dr (2018>)  | ✗ | • | ✗ | • | - | - | - |
|  Corsa C (2000) | ✗ | • | ✗ | • | - | - | - |
| Corsa D (2006>)  | ✗ | • | ✗ | • | - | - | - |
| Corsa VXR (2007>)  | ✗ | • | ✗ | • | - | - | - |
| Crossland X (2018>)  | ✗ | • | ✗ | • | - | - | - |
| Grandland X (2018>)  | ✗ | • | ✗ | • | - | - | - |
| Insignia Hatch (2008>)   | ✗ | • | ✗ | • | - | - | - |
| Insignia Saloon (2009>)  | ✗ | • | ✗ | • | - | - | - |
| Insignia Sports Tourer (2009>)   | ✗ | • | ✗ | • | - | - | - |
| Insignia (2018>)   | ✗ | • | ✗ | • | - | - | - |
| Karl (2015>)   | ✗ | • | ✗ | • | - | - | - |
| Meriva (2002)  | ✗ | • | ✗ | • | - | - | - |
| Meriva (2010>)   | ✗ | • | ✗ | • | - | - | - |
| Mokka (2012>)  | ✗ | • | ✗ | • | - | - | - |
| Mokka X (2018>)  | ✗ | • | ✗ | • | - | - | - |
| Signum (2003 - 2008)   | ✗ | • | ✗ | • | - | - | - |
| Vectra (2002 - 2008)   | ✗ | • | ✗ | • | - | - | - |
| Vectra (2015>)   | ✗ | • | ✗ | • | - | - | - |
| Vivaro (2001)  | ✗ | • | ✗ | • | - | - | - |
| Viva (2015>)   | ✗ | • | ✗ | • | - | - | - |
| Viva (2018>)   | ✗ | • | ✗ | • | - | - | - |
| Zafira (2005 - 2014)   | ✗ | • | ✗ | • | - | - | - |
| Zafira Tourer (2012>)  | ✗ | • | ✗ | • | ✗ | - | ✗ |
| Zafira VXR (2005>)   | ✗ | • | ✗ | • | ✗ | - | ✗ |
|  |   |   |   |   |   |   |   |
| C30 (2006 - 2013)  | ✗ | • | - | • | - | - | - |
| C70 (2005)   | ✗ | • | ✗ | • | - | - | - |
| S40 (2003 - 2012)  | ✗ | • | ✗ | • | - | - | - |
| S60 (2010>)  | ✗ | • | ✗ | • | - | - | - |
|  S80 (2006>)   | ✗ | • | ✗ | • | - | - | - |
|  S90 (2016>)   | ✗ | • | ✗ | • | - | - | - |
| V40 (1996 - 2004)  | ✗ | • | ✗ | • | - | - | - |

Volvo

|  |   |   |   |   |   |   |   |
|--|---|---|---|---|---|---|---|
| V40 (2012>)  | ✗ | • | ✗ | • | - | - | - |
| V40 Cross Country (2013>)  | ✗ | • | ✗ | • | - | - | - |
| V40 (2018>)  | ✗ | • | ✗ | • | - | - | - |
| V50 (2004 - 2012)  | ✗ | • | ✗ | • | - | - | - |
|  V60 (2010>)      | ✗ | • | ✗ | • | - | - | - |
|  V60 PHEV (2015>) | ✗ | • | ✗ | • | - | - | - |
| V60 (2018>)  | ✗ | • | ✗ | • | - | - | - |
|  V70 (2008>)      | ✗ | • | ✗ | • | - | - | - |
| V90 (2016>)  | ✗ | • | ✗ | • | - | - | - |
| V90 Cross-Country (2016>)  | ✗ | • | ✗ | • | - | - | - |
| V90 Cross-Country (2018>)  | ✗ | • | ✗ | • | - | - | - |
| XC40 (2018>)   | ✗ | • | ✗ | • | - | - | - |
| XC60 (2008>)   | ✗ | • | ✗ | • | - | - | - |
| XC60 (2013>)   | ✗ | • | ✗ | • | - | - | - |
| XC60 (2018>)   | ✗ | • | ✗ | • | - | - | - |
| XC70 (2000 - 2007)   | ✗ | • | ✗ | • | - | - | - |
| XC70 (2007>)   | ✗ | • | ✗ | • | - | - | - |
| XC90 (2002 - 2015)   | ✗ | • | ✗ | • | - | - | - |
|  XC90 (2016>)     | ✗ | • | ✗ | • | ✗ | - | ✗ |
|  XC90 (2018>)     | ✗ | • | ✗ | • | - | - | - |
|  |   |   |   |   |   |   |   |
| VW   |   |   |   |   |   |   |   |
|  |   |   |   |   |   |   |   |
| Amarok (2010)  | ✗ | • | ✗ | • | - | - | - |
| Beetle (2012>)   | ✗ | • | - | • | - | - | - |
| Bora (1998 - 2005)   | ✗ | • | ✗ | • | - | - | - |
| Caddy (2000 - 2010)  | ✗ | • | ✗ | • | - | - | - |
| Caddy Maxlife (2010 - 2015)  | ✗ | • | ✗ | • | ✗ | - | ✗ |
| E-Golf Hatch Mk7 (2014>)   | ✗ | • | ✗ | • | ✗ | - | ✗ |
| EOS (2006)   | ✗ | • | ✗ | • | - | - | - |
| EOS (2010)   | ✗ | • | ✗ | • | - | - | - |
|  Fox (2005)       | ✗ | • | ✗ | • | ✗ | - | - |
|  Golf E (2014>)   | ✗ | • | ✗ | • | - | - | - |
| Golf 4 (1997 - 2003)   | ✗ | • | ✗ | • | - | - | - |
| Golf 4 Variant (1996 - 2006)   | ✗ | • | ✗ | • | - | - | - |
| Golf Hatch Mk5 (2004 - 2008)   | ✗ | • | ✗ | • | - | - | - |
| Golf Mk5 (2006 - 2009)   | ✗ | • | ✗ | • | - | - | - |
| Golf Hatch (2008 - 2012)   | ✗ | • | ✗ | • | - | - | - |
| Golf Hatch MK7 (2012>)   | ✗ | • | ✗ | • | - | - | - |

|   |   |   |   |   |   |   |   |
|---|---|---|---|---|---|---|---|
| ⚡ Golf Cabriolet (2009 - 2012)  | X | • | X | • | - | - | - |
| ⚡ Golf GTE Hatch MK7 (2014>)  | X | • | - | • | - | - | - |
| Golf GTI (2009 - 2012>)   | X | • | X | • | - | - | - |
| Golf GTI (2018>)  | X | • | X | • | - | - | - |
| Golf Plus (2009 - 2011)   | X | • | X | • | - | - | - |
| Golf SV (2017)  | X | • | X | • | - | - | - |
| Golf (2018>)  | X | • | X | • | - | - | - |
| Jetta (2011>)   | X | • | X | • | - | - | - |
| Lupo (1999 - 2005)  | X | • | X | • | - | - | - |
| LT (1999)   | X | • | - | • | - | - | - |
| Multivan Caravelle (2003>)  | X | • | X | • | - | - | - |
| Multivan Caravelle (2008>)  | X | • | - | • | • | X | • |
| New Beetle (1998 - 2002)  | X | • | - | • | • | X | • |
| Passat (1996 - 2005)  | X | • | X | • | - | - | - |
| Passat (2005 - 2010)  | X | • | X | • | - | - | - |
| Passat (2010 - 2015)  | X | • | X | • | - | - | - |
|  Passat Estate (2005 - 2011) | X | • | X | • | - | - | - |
|  Passat Estate (2011 - 2015) | X | • | X | • | - | - | - |
|  Passat Estate (2015>)       | X | • | X | • | - | - | - |
|  Passat Saloon (2015>)       | X | • | X | • | - | - | - |
| Passat (2018>)  | X | • | X | • | - | - | - |
| Passat Alltrack (2012>)   | X | • | X | • | - | - | - |
| Passat CC (2008>)   | X | • | X | • | - | - | - |
| Phaeton (2002)  | X | • | X | • | - | - | - |
| Polo 3 (1994 - 2001)  | X | • | X | • | - | - | - |
| Polo 4 (2005 - 2009)  | X | • | X | • | - | - | - |
| Polo 5 (2009)   | X | • | X | • | - | - | - |
| Polo 3dr (2009>)  | X | • | X | • | - | - | - |
| Polo 5dr (2009>)  | X | • | X | • | - | - | - |
| Polo 5dr (2018>)  | X | • | X | • | - | - | - |
| Polo GTI (2018>)  | X | • | X | • | - | - | - |
| Scirocco (2008)   | X | • | X | • | - | - | - |
| Scirocco (2011)   | X | • | - | • | - | - | - |
| Sharan (1998)   | X | • | • | • | • | • | • |
| Sharan (2004)   | X | • | - | • | - | - | - |
| SBI Sharan (2010>)  | X | ! | X | ! | X | - | X |
| SBI Sharan (2018>)  | X | ! | • | ! | • | • | • |
| T4 Caravelle (1999)   | X | • | • | X | X | X | X |
| Multivan (1999 - 2003)  | X | • | X | • | • | - | • |

|  |   |   |   |   |   |   |   |
|--|---|---|---|---|---|---|---|
| T5 Kombi (2003)  | X | • | • | X | - | - | - |
| Multivan (2003)  | X | • | X | • | • | - | • |
| Tiguan (2007 - 2016)   | X | • | X | • | - | - | - |
|  Tiguan (2016>)           | X | • | X | • | - | - | - |
|  Touareg (2002 - 2010)    | X | • | X | • | - | - | - |
| Touareg (2010>)  | X | • | X | • | - | - | - |
| Touareg (2012>)  | X | • | X | • | - | - | - |
| Touareg (2018>)  | X | • | X | • | - | - | - |
| Touareg MK 1 (2009)  | X | • | X | • | - | - | - |
| Touran (2003 - 2010)   | X | • | X | • | - | - | - |
|  SBI! Touran (2010 - 2015) | X | ! | X | ! | X | - | X |
| Touran (2016>)   | X | • | • | • | X | - | X |
| Transporter LT3 (2006)   | X | • | X | • | - | - | - |
| T-Roc (2018>)  | X | • | X | • | - | - | - |
| UP! (2011>)  | X | • | X | • | - | - | - |
| ⚡ E - UP! (2014>)  | X | • | X | • | - | - | - |
| ⚡ E - UP! 3dr (2018>)  | X | • | X | • | - | - | - |
| ⚡ E - UP! 5dr (2018>)  | X | • | X | • | - | - | - |





Allison Baby UK Ltd,  
Venture Point, Towers Business Park  
Rugeley, Staffordshire, WS15 1UZ

bring the kids™

Share the joy at [joiebaby.com](http://joiebaby.com)

IM-000985G